



SISTEMAS DE CANALIZACIÓN

Distribuido por | **bticino**

RTGAMMA | CHAROLA PVC | CABLOFIL | **bticinomacse**

bticino

Tableros de Alumbrado y Distribución





Índice

2-132		
Sistema de canalización	Para cables	2
	CABLOFIL	4
	Charola de aluminio	82
	Ducto cuadrado	109
	Unicanal	115
	RTGAMMA - Ducto metálico	116
	Charola PVC	132

SISTEMA DE CANALIZACIÓN

Los sistemas de canalización determinan de manera clara y específica la dirección y distribución de los diferentes sistemas de energía y control, a la vez que proporcionan un apoyo básico para el funcionamiento de todos los equipos. Son ajustables, fáciles de instalar, requieren de poco mantenimiento y en cualquier momento se pueden adaptar a las nuevas exigencias.

■ CLASIFICACIÓN DE LA CANALIZACIÓN

La variedad de sistemas de canalización tipo charola está concentrada en aquellos que son capaces de soportar grandes cantidades de cables, ya sean de calibres delgados o gruesos. Por lo que por su construcción se clasifican en 5 tipos de charola:

Tipo Canal

Tipo Escalera

Tipo Fondo sólido

Tipo Fondo ventilado

Tipo Malla

■ MATERIALES DE FABRICACIÓN

En vista de que los sistemas de canalización son especialmente para cableados eléctricos y de control, el material con el que se fabrican debe ser conductor eléctrico y deberá estar aterrizado para que sirva como sistema de protección, así mismo debe ser ligero, ajustable, fuerte y resistente a la corrosión. Debido a esto se fabrican en aluminio, acero inoxidable o acero al carbón con recubrimiento anticorrosivo.

Los accesorios son de acero, aluminio o alguna de sus aleaciones cumpliendo con la norma NMX-J-511-ANCE-1999, para que tengan la rigidez y resistencia mecánica necesaria y con un recubrimiento anticorrosivo (a excepción del aluminio y el acero inoxidable).

■ ALUMINIO

BTICINOMACSE cuenta con sistemas de soporte tipo charola con aluminio de aleación comercial 6063 temple 6 en acabado natural.

El aluminio es más ligero, ya que sólo pesa un poco más de la mitad que el acero, es muy resistente a la corrosión y por ser un material no magnético se le considera casi libre de mantenimiento y con excelente resistencia mecánica.

■ ACERO

Tiene la ventaja de ser un material muy resistente y de bajo costo, por lo que generalmente se le aplica una capa protectora que puede ser de varios tipos según la norma mexicana NMX-J-511-ANCE-1999.

TIPO 1. Galvanizado por inmersión en caliente después de su fabricación.

TIPO 2. Galvanizado por inmersión en caliente laminado.

TIPO 3. Galvanizado electrolítico.

Cuando los soportes metálicos tipo charola sean destinados a instalaciones y ambientes de alta corrosión, incluyendo condiciones alcalinas y ácidas, además de protección contra la corrosión, se proveen protecciones adicionales como recubrimientos epóxicos, acrílicos, polietilenos, poliésteres o híbridos.

■ ACERO INOXIDABLE

El acero inoxidable es una aleación no un revestimiento. Existen diferentes grados de aceros inoxidables.

Los estándares en el mercado de soportería para cables establecen como estándar:

Acero inoxidable 304: Grado alimenticio. Industria alimenticia básicamente.

Acero inoxidable 316: Grado marino. Contiene también Molibdeno.

Para instalarse en zonas de mayor corrosión como la costa, industria petroquímica y ambientes limpios.

La mención L indica un nivel muy bajo de carbón en el acero inoxidable.

Existen tratamientos finales de descontaminación como el decapado y pasivado del acero inoxidable después de la fabricación para darle mayor protección.

■ PVC

El policloruro de vinilo (PVC) es utilizado en la fabricación de las charolas de fondo perforado de BTicino por ser un material de poco peso lo que facilita el transporte y aplicación. Aunado a esto ofrece ventajas como son la alta resistencia a la mayoría de los reactivos químicos, la formación de hongos, bacterias y ataques de roedores. El PVC es un material no sensible a la corrosión lo que permite su instalación en exteriores.

■ SELECCIÓN DEL TIPO DE CHAROLA

La selección del tipo y tamaño de charola necesario para una instalación, debe comenzar con el cálculo del número de conductores que se guiarán a través de este sistema determinado, así como el ancho y peso que deberá soportar.

Con esta información se pueden determinar las cargas presentes y las que puedan presentarse, las cuales se pueden clasificar en:

CARGAS MUERTAS O

ESTÁTICAS. Son aquellas que no cambian su magnitud y están en lugares fijos. Pueden ser el peso mismo de la charola, los accesorios de montaje, tuberías, etc.

CARGAS CONCENTRADAS. Éstas representan un peso estático aplicado entre los largueros de la charola. Pueden ser las cajas de registro, balastos y equipos varios.

CARGAS VIVAS. Son aquellas que cambian de magnitud o varían en su localización como la variación de peso de los cables al modificar la instalación existente o una carga concentrada.

CARGAS DINÁMICAS. Son cargas de impacto causadas por temblores, viento, esfuerzos mecánicos producidos por cortos circuitos, etc.

■ CAPACIDAD DE CARGA MECÁNICA

A su vez, los soportes se clasifican por su capacidad de carga mecánica, la que se divide en tres categorías:

- Baja
- Media
- Alta

Por lo que se deben tomar en consideración la cantidad de cables a soportar y su peso en kg/m para determinar los claros entre apoyos necesarios para su montaje, así como la capacidad de carga de cada categoría.

La clasificación de tipo de charola de la Tabla 1 (ver pág. 84) se compone de dos caracteres distintivos: el primero se refiere al claro entre apoyos y el segundo a la capacidad de carga mecánica del soporte tipo charola para cables.

¿Qué significan estos símbolos?

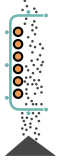

CAÍDA DE POLVO



FIJACIÓN SIN TORNILLERÍA



UNIÓN CON TORNILLERÍA



RAPIDEZ DE MONTAJE



UNIÓN SIN TORNILLERÍA PATENTADA

FASL
FAST ASSEMBLING SYSTEM



PATENTADO



BORDE DE SEGURIDAD PATENTADO

P1500

P2000

DISTANCIA ENTRE SOPORTES DE 1,5 M (P1500) O 2 M (P2000) CON LLENADO MÁXIMO



CEI 61.537

CONTINUIDAD ELÉCTRICA CONFORME



ANCHO



LARGO



ALTO



PESO



CEI 61.537 NORM

CARGA PRÁCTICA DE SEGURIDAD EN DAN



MOMENTO



BEST OF

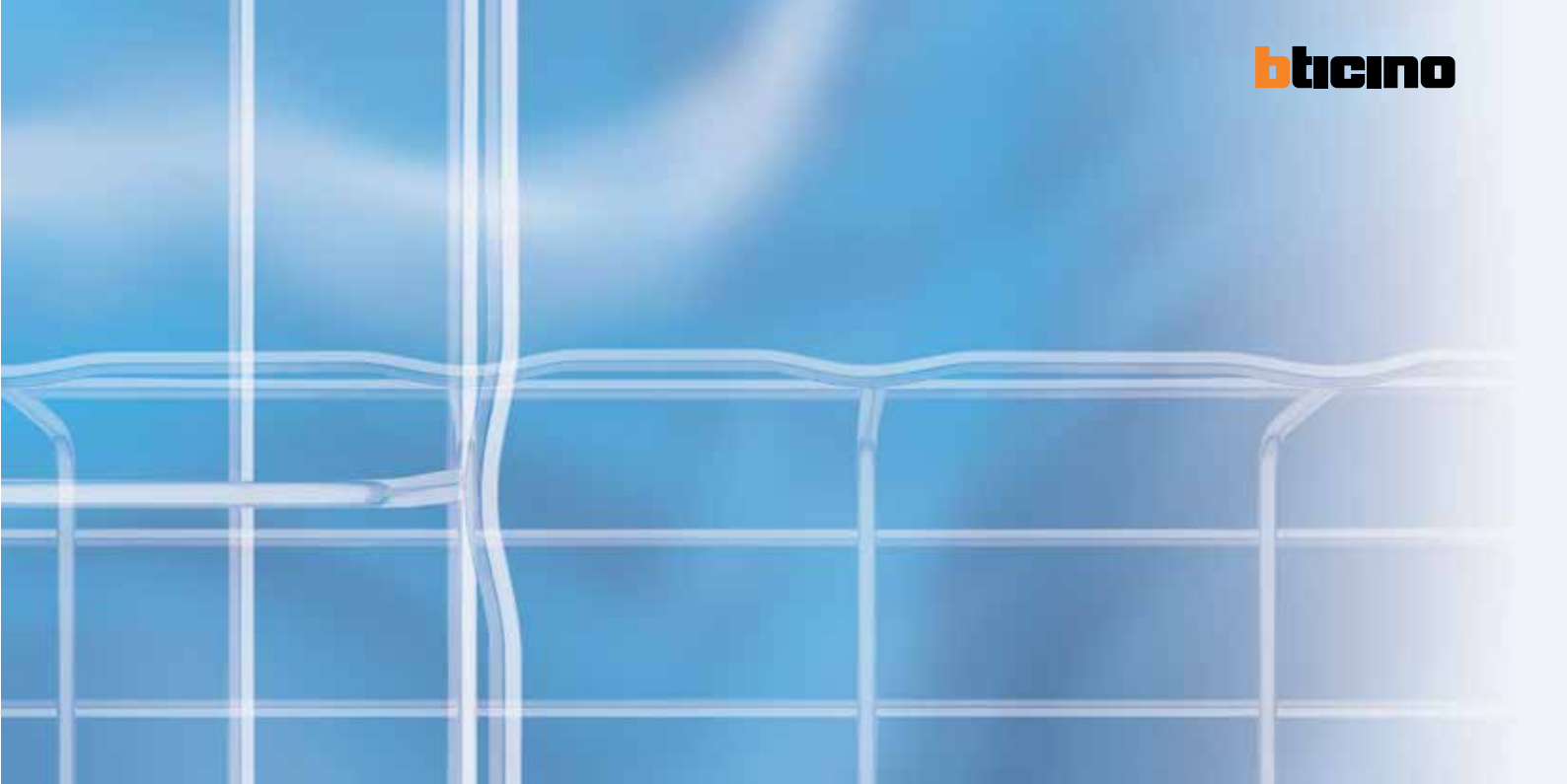

Índice

2-132
CABLOFIL



La gama

12



Uniones

22



Instalación mural

29



Instalación en el techo

36



Otras soluciones

45



Instalación de las bandejas

61

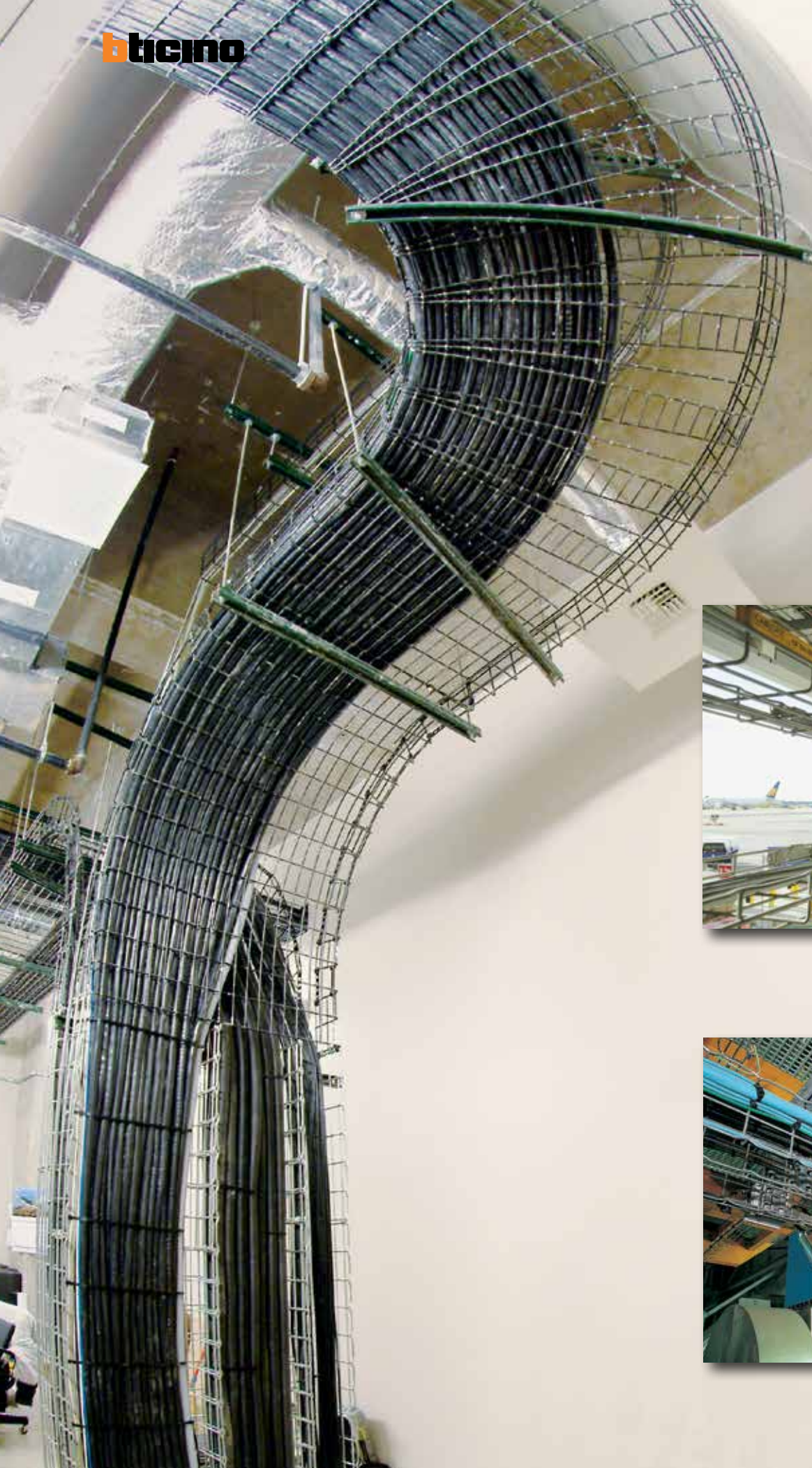



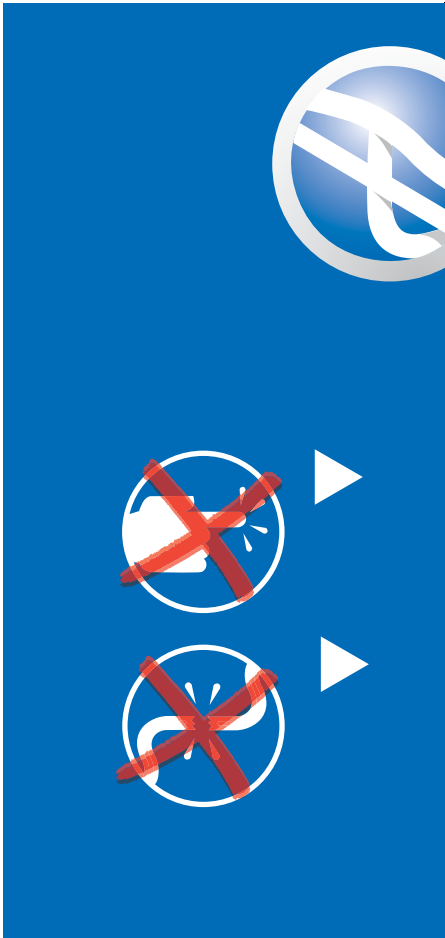

A blue vertical bar containing three icons. At the top is a white circle with a blue hand holding a wire. Below it are two white circles with red 'X' marks over them, each containing a hand holding a wire. Small white triangles point to the right between the icons.



A green vertical bar containing four icons. At the top is a white circle with a green hand holding a wire. Below it is the 'FAST' logo with 'FAST ASSEMBLING SYSTEM' underneath and a small illustration of the assembly process. Below that is a white circle with a red 'X' mark over a hand holding a wire. At the bottom is a white circle with the word 'PATENTED' around a central dot. Small white triangles point to the right between the icons.

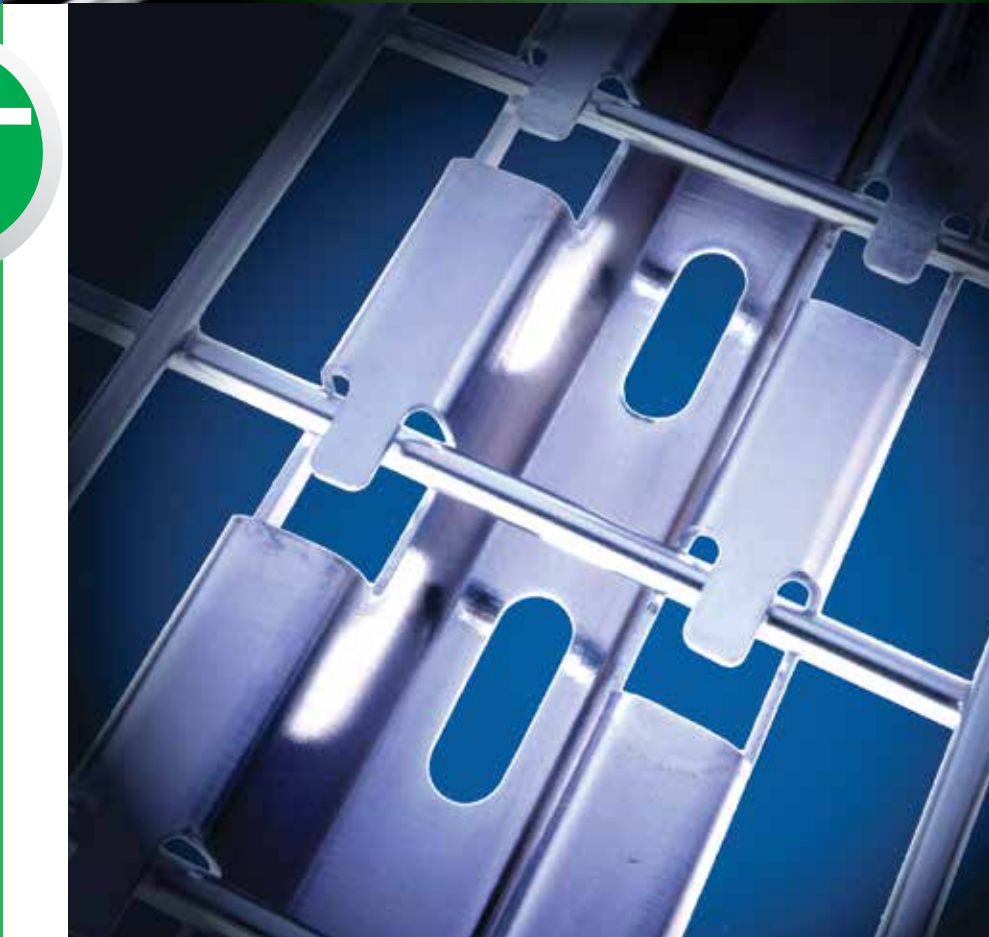

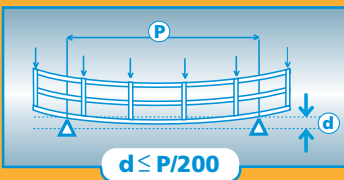

MATERIALES Y RECUBRIMIENTOS

LOS SISTEMAS DE CANALIZACIÓN ESTÁN PRINCIPALMENTE EXPUESTAS A LA CORROSIÓN ATMOSFÉRICA. EL AMBIENTE EN EL CUAL SE ENCUENTRA LA CHAROLA ES EL CRITERIO DOMINANTE EN LA ELECCIÓN DEL TRATAMIENTO DE SUPERFICIE O DEL TIPO DE ACERO.

EZ ELECTROZINCADO DESPUÉS DE FABRICACIÓN

Standard EN 12 329
CABLOFIL EZ, fabricadas a partir de varillas de acero bruto, se decapan y posteriormente son sometidas a un baño electrolítico de zinc. El paso de una corriente eléctrica provoca entonces el depósito del zinc sobre el acero. Como resultado, se obtiene un aspecto liso y gris más o menos azulado y brillante, lo cual depende del pH del baño electrolítico utilizado. En todo caso, ni el color y ni el brillo tienen ningún efecto positivo o negativo, sobre la resistencia a la corrosión del revestimiento.

GS GALVANIZACIÓN ANTES DE FABRICACIÓN EN CONTINUO POR EL PROCEDIMIENTO SENDZIMIR

Norma GS (accesorios) : EN 10142
Antes de la fabricación, se deposita un revestimiento de zinc por inmersión continua de la chapa o de las varillas de acero.
El aspecto de las piezas resulta entonces lisa y gris.

GC GALVANIZADO EN CALIENTE DESPUÉS DE FABRICACIÓN

Norma EN ISO 14 61
CABLOFIL GC o sus accesorios fabricados a partir de chapa o de varillas de acero bruto, después del proceso de desengrasado y decapado, son sumergidos en un baño de zinc fundido. De este modo, todas las piezas quedan recubiertas de una importante capa de zinc.
Obtenemos un aspecto gris claro ligeramente rugoso.

NOTA: los rastros blancos, debidos a la formación de hidroxycarbonato de zinc que puede aparecer en superficie, no afectan a la resistencia a la corrosión. Se trata del mismo principio de la protección galvánica.

DC GEOMET®

El revestimiento de zinc o de aluminio confiere a las piezas un aspecto gris claro, liso y sin rugosidades. Geomet® ofrece una protección equivalente a la del GC, aunque se utiliza únicamente para los pequeños accesorios y uniones, porque resultan difíciles de galvanizar en caliente.

RECUBRIMIENTO EPÓXICO

La pintura a base de resinas es aplicada por polvo electrostático y luego es cocida al horno. Todos los colores RAL son posibles.
Esencialmente utilizado por razones estéticas, el epoxy presenta una resistencia muy buena a la corrosión.

ACERO INOXIDABLE 304 L

304L

Norma EN 10088-2 – AISI 304L – X2CrNi18.09
Ofrece una buena resistencia a la corrosión en presencia de agua dulce, ambientes naturales y productos alimenticios (excepto la mostaza y el vino blanco).

ACERO INOXIDABLE 316 L

316L

Norma EN 10088-2 – AISI 316L – X2CrNiMo17.12.2
La presencia de molibdeno en su composición hace que sea insensible a la corrosión intergranular y que su rendimiento sea excelente en la industria química, la alimentaria, la industria de nitratos explosivos, talleres de decoración, laboratorios de fotografía y ambientes halógenos (flúor y cloro).









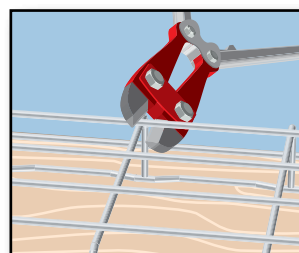

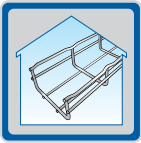



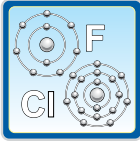







COMBINACIÓN DE CHAROLA CON ACCESORIOS

Charola	Accesorios
EZ	EZ-GS
GC	GC-DC
IN304L	IN304L-IN316L
IN316L	IN316L

LA PROTECCIÓN CONTINUA ...

El hecho de cortar las varillas con una cizalla no deteriora la protección del revestimiento: las cuchillas de la cizalla arrastran consigo la capa de zinc sobre la zona cortada y se crea entonces un acoplamiento galvánico protector.







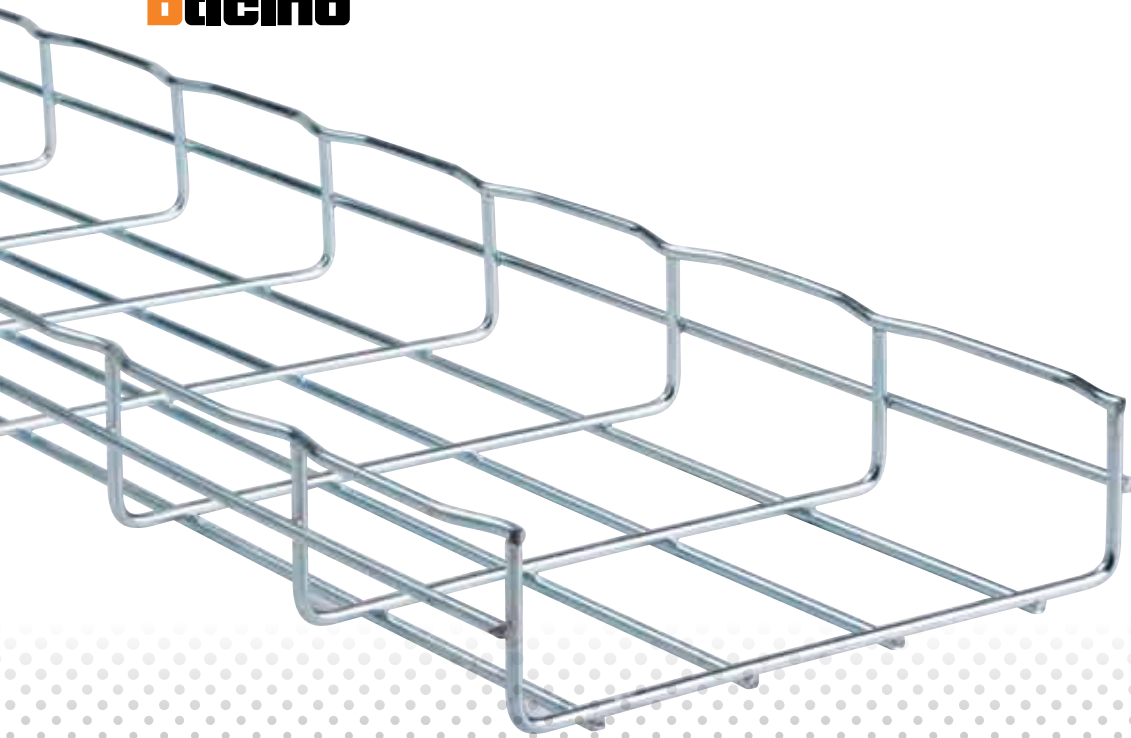

		INTERIORES 	EXTERIORES 	INDUSTRIA QUÍMICA 	PLATAFORMAS MARINAS 	IND. CLUOR, FLUOR 	IND. ALIMENTARIA 
<p>EZ</p> <p>ISO 20-81/82 NF/EN 12-329 DIN 50961</p>	Zincado electrolítico						
<p>GS</p> <p>NF/EN 10-327 DIN 50976 ≈EZ</p>	Galvanizado en continuo						
<p>GC</p> <p>NF/EN/ISO 1461</p>	Galvanización en caliente						
<p>DC</p> <p>≈GC</p>	Protección zinc más aluminio						
<p>304L</p> <p>NF 10-088-2 Decapado y pasivado</p>	Acero inoxidable 304 L						
<p>316L</p> <p>NF 10-088-2 Decapado y pasivado</p>	Acero inoxidable 316 L						

 Recomendado

 Posible



Índice

13-21		CF 30	13
La Gama		CF 54	14
		CF 105 CF 150	15 16
		TXF 34 G-MINI	17 18
		FCF 54 - FASCLIC	19
		CP - CVN COT	20 21

CF 30



CF 30 \updownarrow 30 MM \leftarrow 50 \rightarrow 300 MM \rightleftarrows 3M

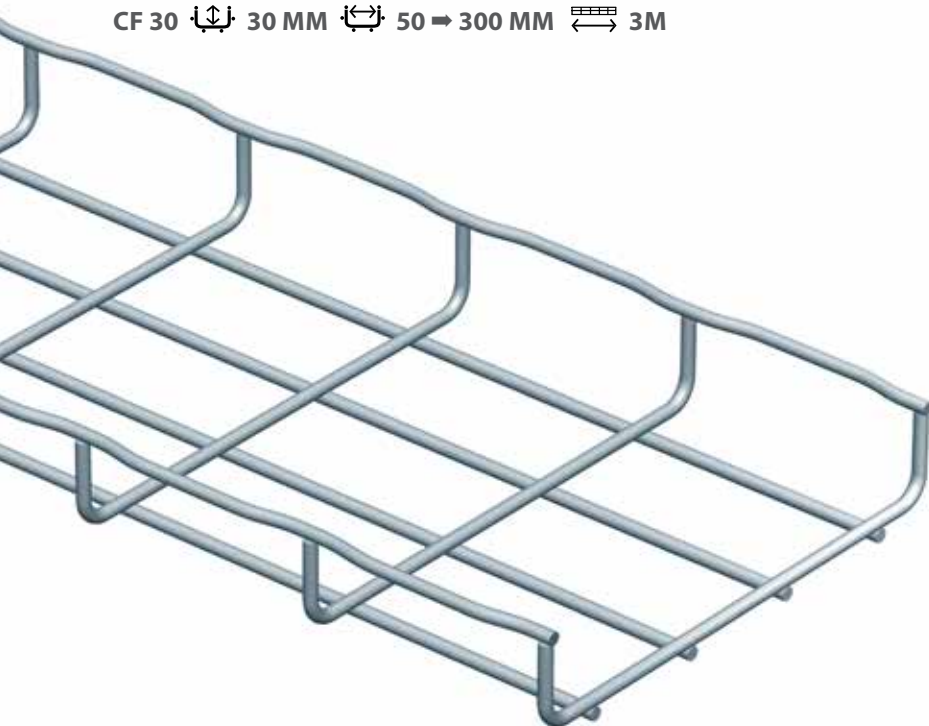

-  CF 30/50
-  CF 30/100
-  CF 30/150
-  CF 30/200
-  CF 30/300

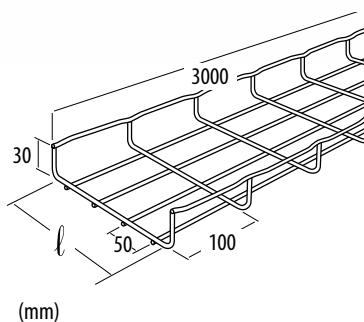

	l mm	kg kg/m	EZ	GC	304L	316L
CF 30/50*	50	0,38	000 011	000 013	000 018	000 014
CF 30/100	100	0,52	000 021	000 023	000 028	000 024
CF 30/150	150	0,67	000 031	000 033	000 038	000 034
CF 30/200	200	0,92	000 041	000 043	000 048	000 044
CF 30/300	300	1,37	000 051	000 053	000 058	000 054



NOTA: Para mallas en colores, preguntar disponibilidad de colores y precios con su vendedor.

EZ - GC

P1500

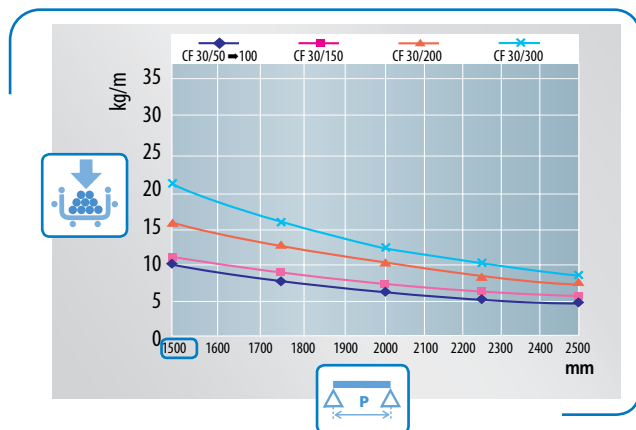

304L - 316L

P1500

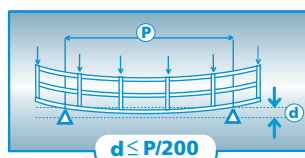
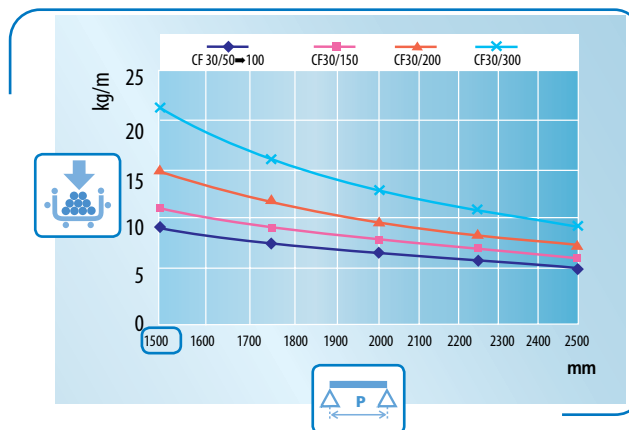

CF 54



CF 54 \updownarrow 54 MM \leftrightarrow 50 \rightarrow 600 MM \rightleftarrows 3M

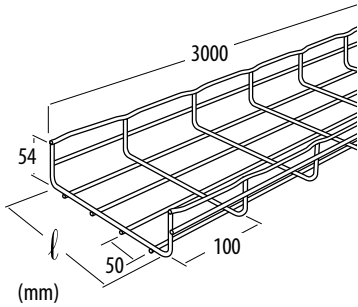
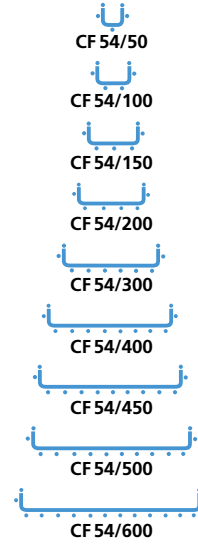
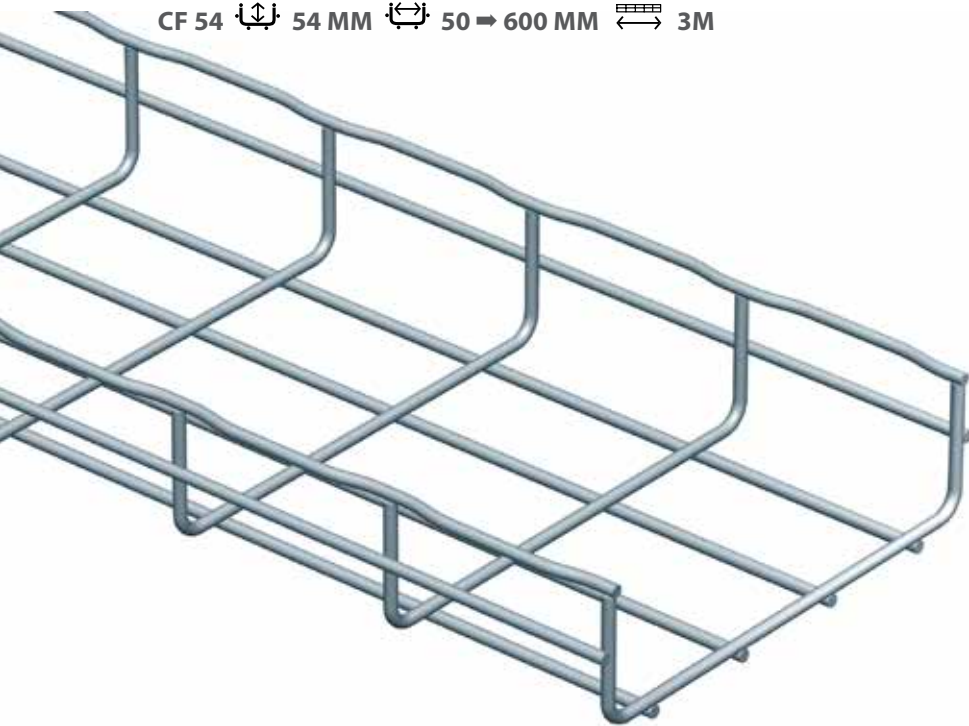

	l mm	kg/m	EZ	GC	304L	316L
CF 54/50	50	0,61	000 061	000 063	000 068	000 064
CF 54/100	100	0,76	000 071	000 073	000 078	000 074
CF 54/150	150	1,01	000 081	000 083	000 088	000 084
CF 54/200	200	1,32	000 091	000 093	000 098	000 094
CF 54/300	300	1,99	000 101	000 103	000 108	000 104
CF 54/400	400	2,97	000 201	000 203	000 208	000 204
CF 54/450	450	3,36	000 251	000 253	000 258	000 254
CF 54/500	500	3,37	000 301	000 303	000 308	000 304
CF 54/600	600	3,79	000 401	000 403	000 408	000 404

NOTA: Para mallas en colores, preguntar disponibilidad de colores y precios con su vendedor.

EZ - GC

P2000

304L - 316L

P1500

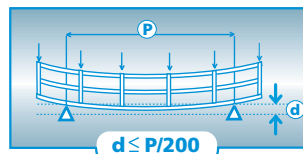
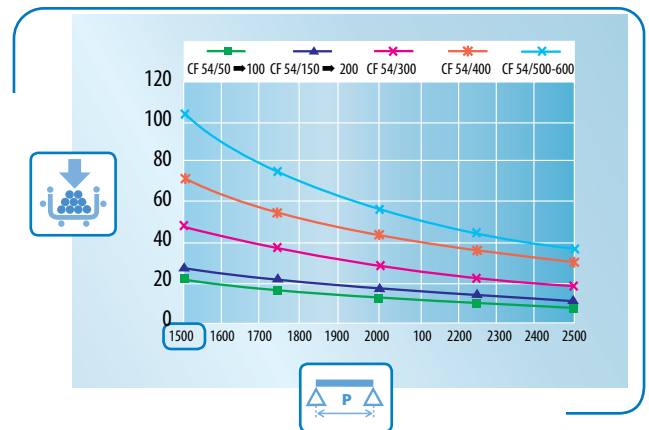
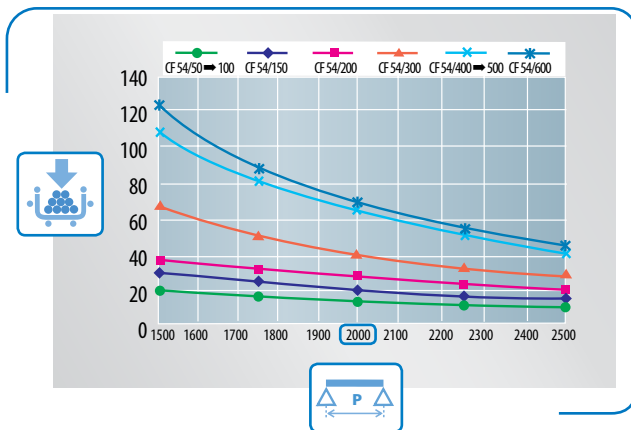

CF 105



CF 105 105 MM 100 → 600 MM 3M

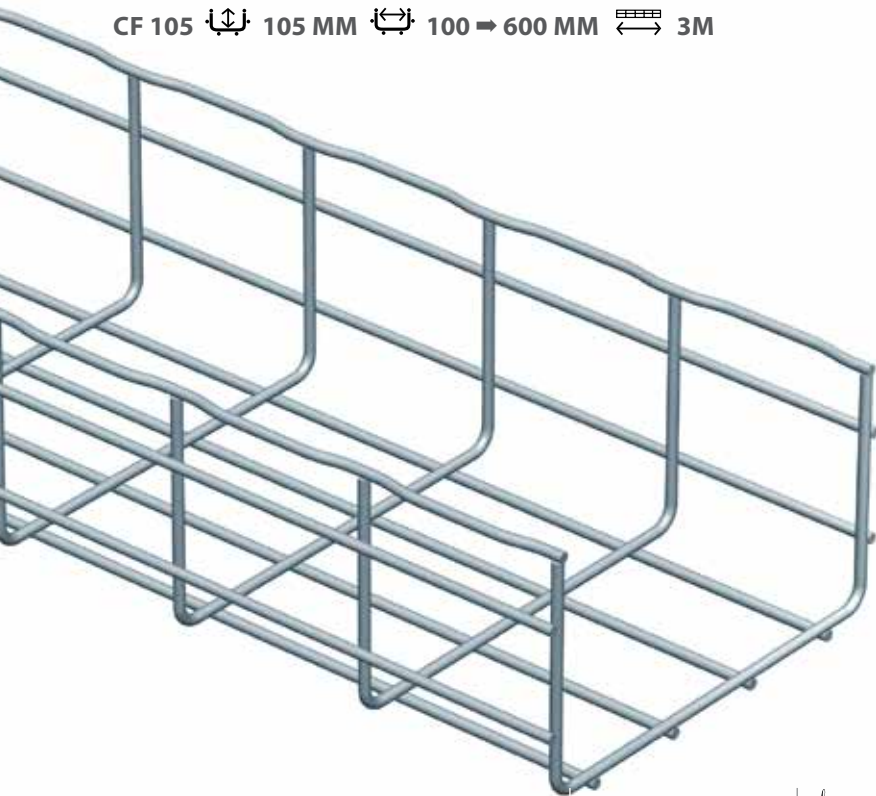

CF 105/100

CF 105/150

CF 105/200

CF 105/300

CF 105/400

CF 105/450

CF 105/500

CF 105/600

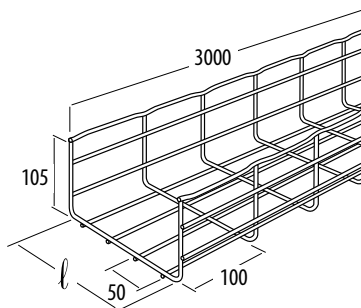

(mm)

	l mm	kg kg/m	EZ	GC	304L	316L
CF 105/100	100	1,32	000 891	000 893	000 898	000 894
CF 105/150	150	1,69	000 901	000 903	000 908	000 904
CF 105/200	200	1,99	000 911	000 913	000 918	000 914
CF 105/300	300	2,96	000 921	000 923	000 928	000 924
CF 105/400	400	3,37	000 931	000 933	000 938	000 934
CF 105/450	450	3,60	001 931	001 933	941 072	941 073
CF 105/500	500	3,78	000 941	000 943	000 948	000 944
CF 105/600	600	4,19	001 031	001 033	001 038	001 034

NOTA: Para mallas en colores, preguntar su disponibilidad y precios con su vendedor.

EZ - GC

P2000

304L - 316L

P1500

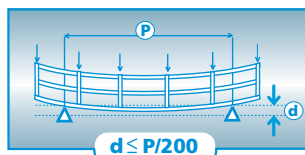
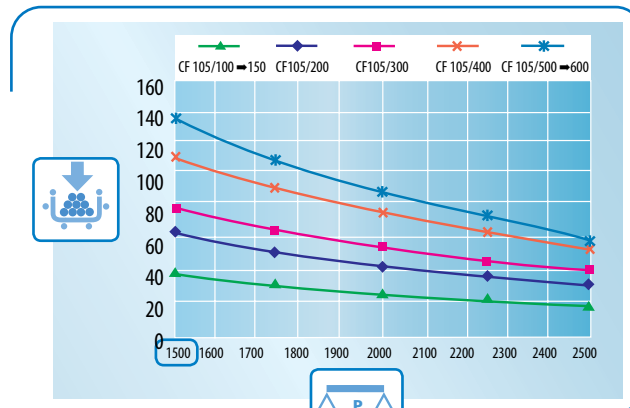
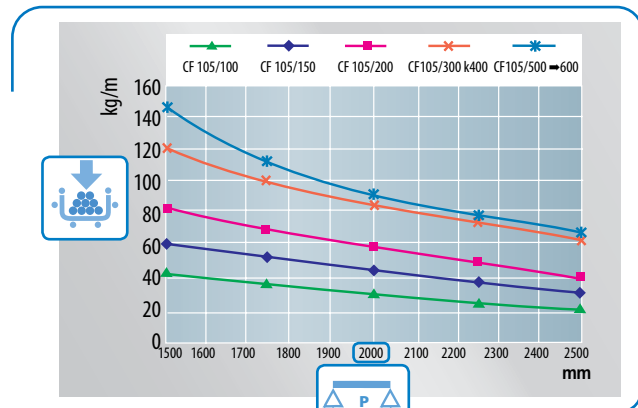

CF 150



CF 150 105 MM 200 → 500 MM 3M

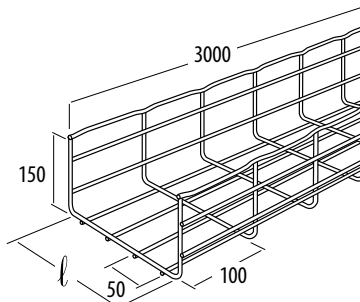
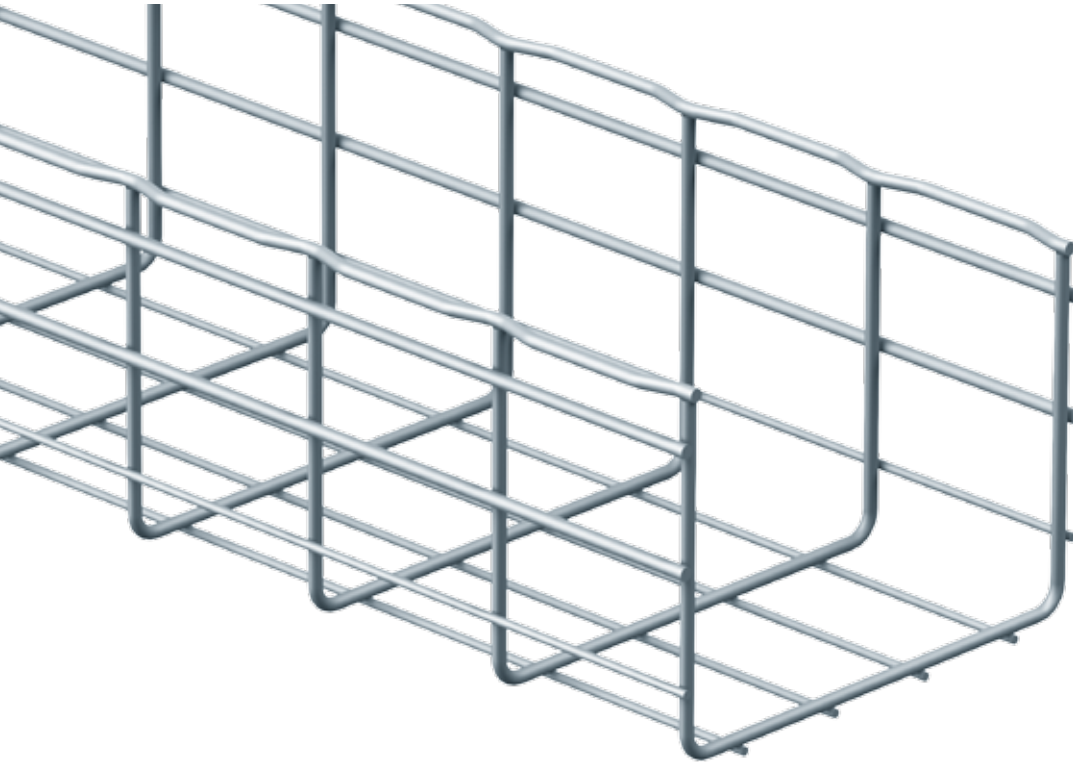

(mm)

	l mm	kg kg/m	EZ	GC	304L	316L
CF 150/200	200	3,10	000 951	000 953	000 958	000 954
CF 150/300	300	3,50	000 961	000 963	000 968	000 964
CF 150/400	400	3,90	000 971	000 973	000 978	000 974
CF 150/450	450	4,10	001 011	001 013	001 018	001 014
CF 150/500	500	4,40	001 021	001 023	001 028	941 080

NOTA: Para mallas en colores, preguntar su disponibilidad y precios con su vendedor.

EZ - GC

P2000

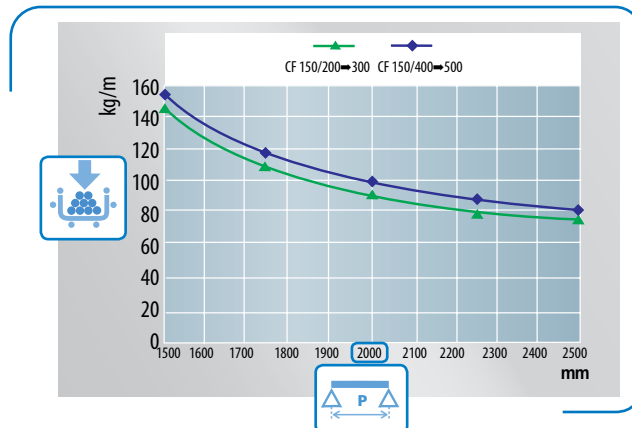

TXF 35

TXF 35 35 MM 35 MM 3M

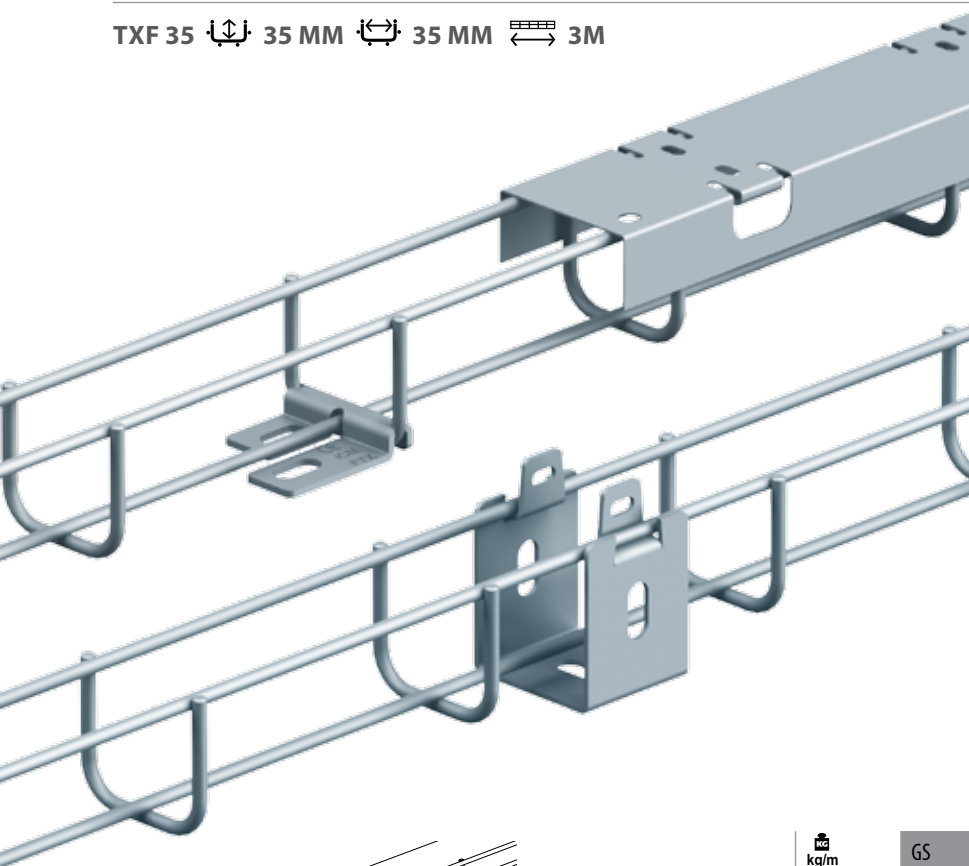

FTX

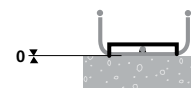

UC35

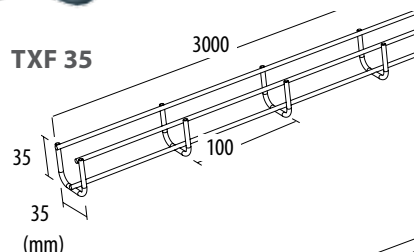
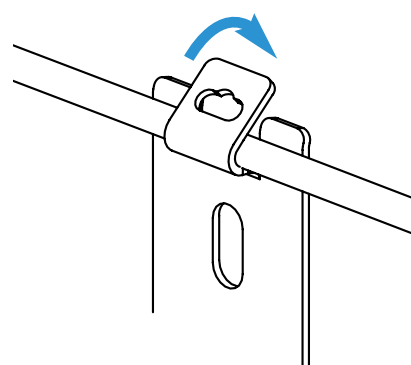
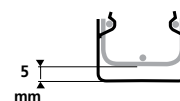

TXF 35

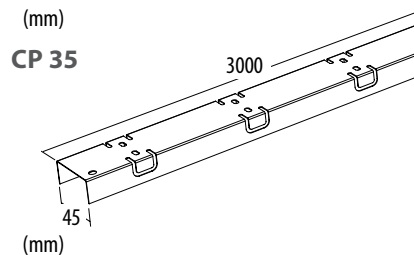

CP 35

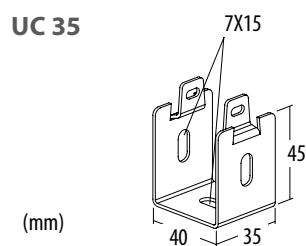

UC 35

FTX

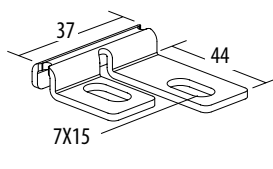

	kg/m	GS	EZ	GC	304L	316L
TXF 35	0,53	-	755 001	755 003	755 008	755 004
CP 35	0,41	755 100	-	755 103	-	755 104
UC 35	-	586 160	-	586 163	-	586 164
FTX	-	586 180	-	586 183	-	586 184

G-MINI

G-MINI  50 MM  50 MM  3M

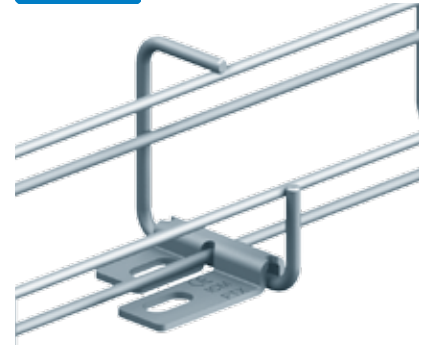
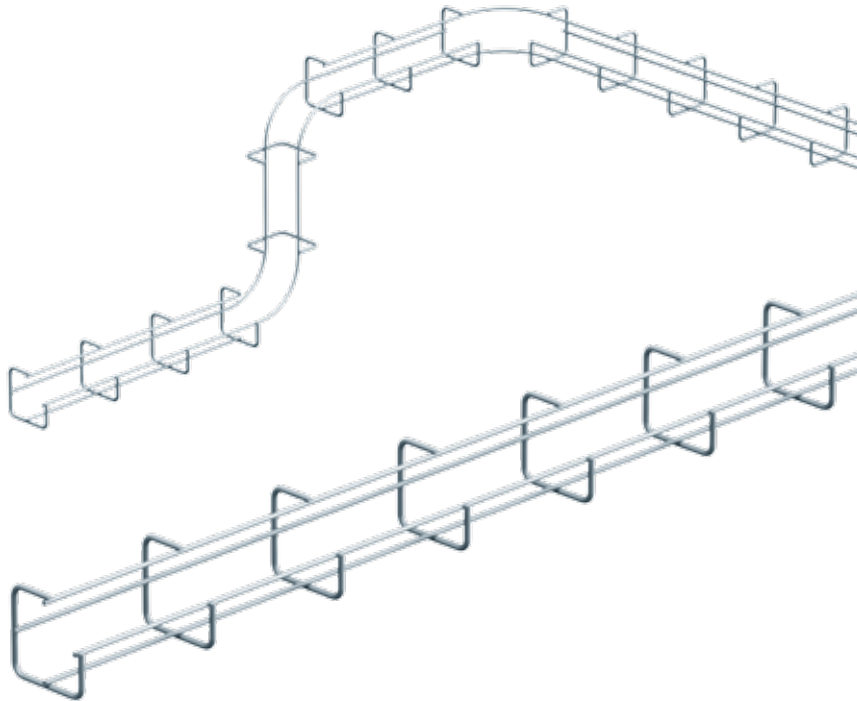

G-MINI → FTX

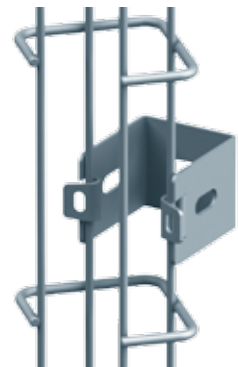

G-MINI → UC35

G-MINI

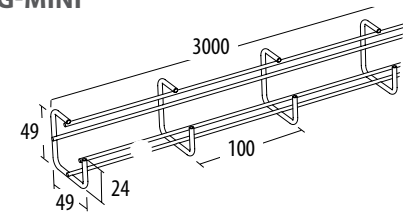

(mm)

UC 35

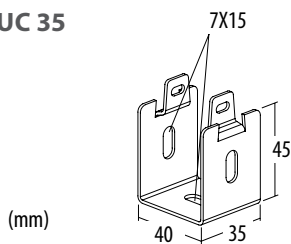

(mm)

FTX

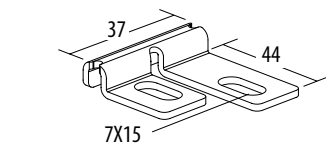

(mm)

	kg/m	GS	EZ	GC	304L	316L
G-MINI	0,40	-	430 111	-	-	430 114

UC 35	-	586 160	-	586 163	-	586 164
-------	---	---------	---	---------	---	---------

FTX	-	586 180	-	586 183	-	586 184
-----	---	---------	---	---------	---	---------

FCF 54 - FASCLIC



FCF 54 FASCLIC 54 MM 50 → 200 MM 3M

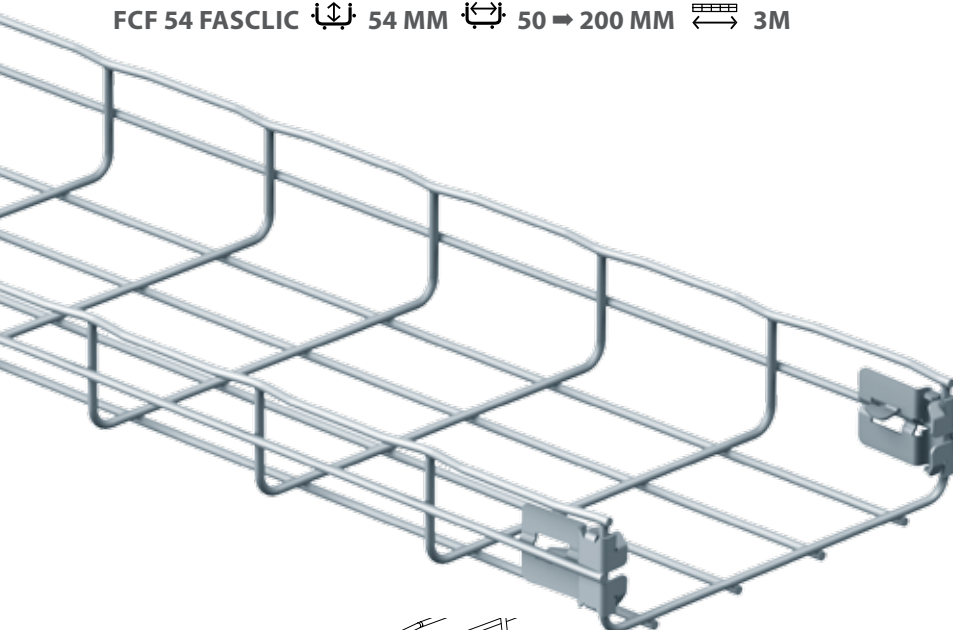

- CF 54/50
- CF 54/100
- CF 54/150
- CF 54/200

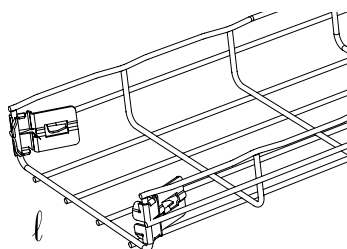

	l mm	kg/m	EZ	GC	304L	316L
FCF 54/50	50	0,64	081 061	-	081 068	081 064
FCF 54/100	100	0,79	081 071	-	081 078	081 074
FCF 54/150	150	1,06	081 081	-	081 088	081 084
FCF 54/200	200	1,35	081 091	-	081 098	081 094

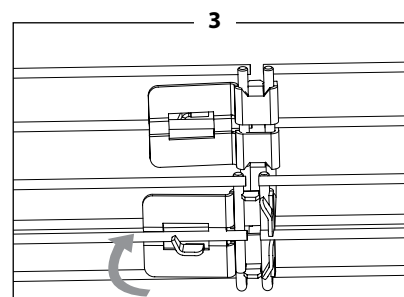
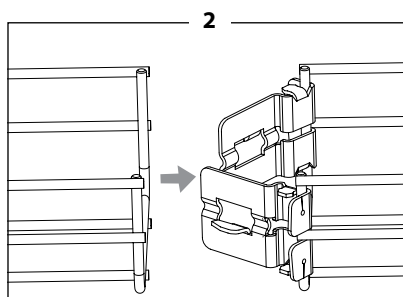
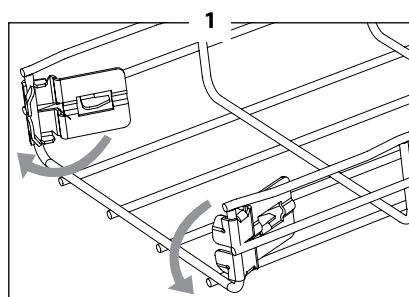

EZ - GC

P2000

304L - 316L

P1500

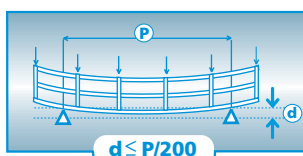
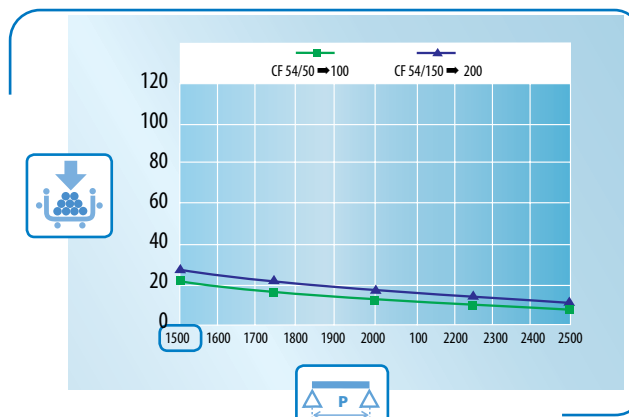
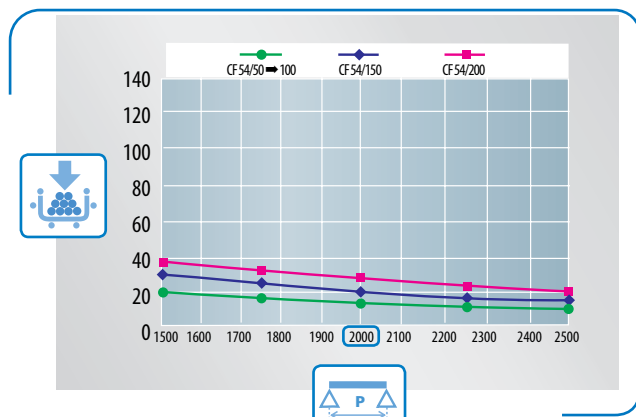

CP-CVN



CP-CVN CF30 - CF54 - CF105 50 → 600 MM

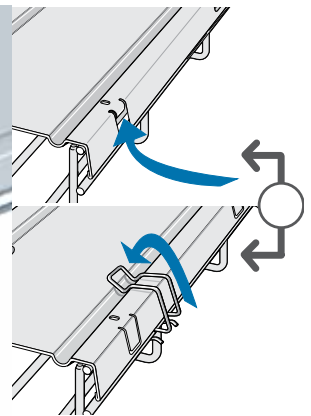
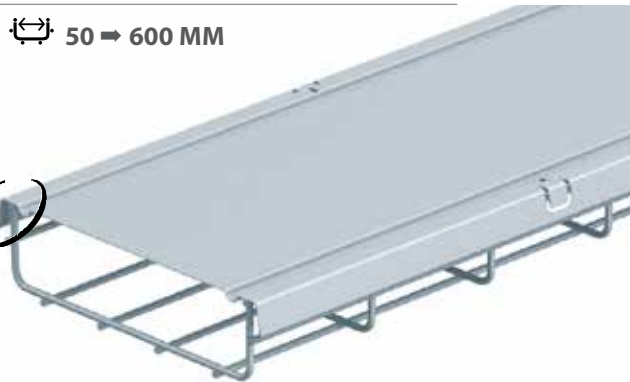
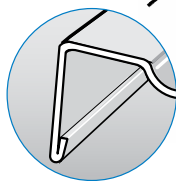
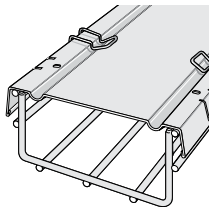

CVN

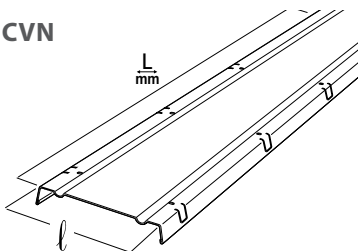

1x2m

3x1m

	l mm	L mm	kg/m	GS	GC	304L	316L
CP 50	71	2000	0,4	646 010	646 013	646 018	646 014
CP 100	121	2000	0,7	646 020	646 023	646 028	646 024
CP 150	171	2000	1,1	646 030	646 033	-	646 034
CP 200	221	2000	1,4	646 040	646 043	-	646 044
CP 300	322	2000	2,0	646 050	646 053	-	646 054
CP 400	425	2000	3,5	646 060	646 063	-	646 064
CP 450	475	2000	3,4	646 090	646 093	-	646 094
CP 500	525	2000	4,3	646 070	646 073	-	646 074
CP 600	625	2000	5,0	646 080	646 083	-	646 084
CVN 50	71	1000	0,4	629 050	629 053	629 058	629 054
CVN 100	121	1000	0,7	629 100	629 103	-	629 104
CVN 150	171	1000	1,1	629 150	629 153	-	629 154
CVN 200	221	1000	1,4	629 200	629 203	-	629 204
CVN 300	322	1000	2,0	629 300	629 303	-	629 304
CVN 400	425	1000	3,5	629 400	629 403	-	629 404
CVN 450	475	1000	3,4	629 450	629 453	-	629 454
CVN 500	525	1000	4,3	629 500	629 503	-	629 504
CVN 600	625	1000	5,0	629 600	629 603	-	629 604

CLIP

CLIP ~~CF30~~ - CF54 - CF105 50 → 600 MM

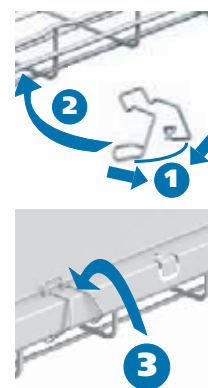

CLIP F02

(mm)

CLIP F02 → CF 54 - CF 105

		GS	GC	304L	316L
CLIP F02	25	646 200	-	-	646 204

COT



COT CF30 - CF54 - CF105 100 → 600 MM

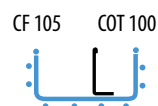
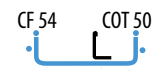
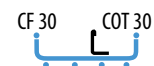
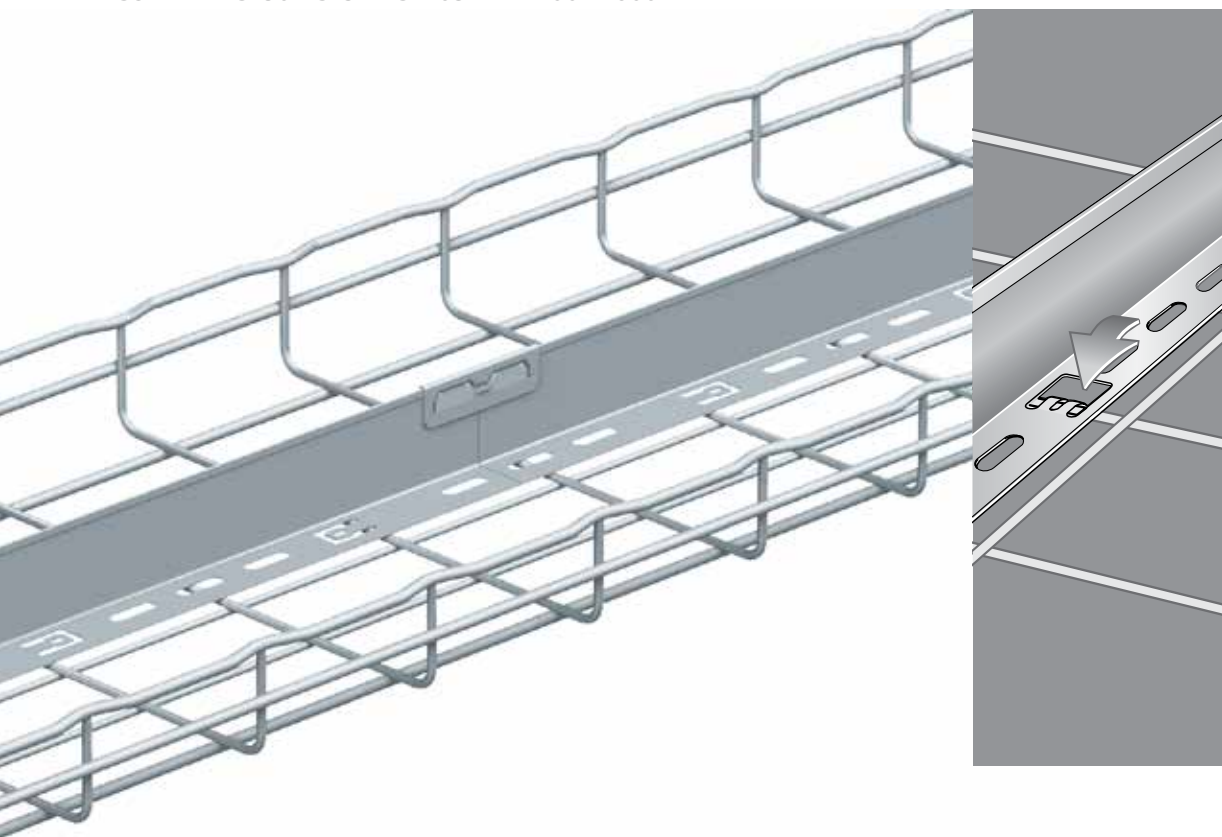

COT

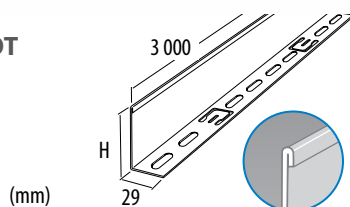

(mm)

	Hi mm	kg/m	GS	GC	304L	316L
COT 30	24	0,3	923 010	923 013	-	923 014
COT 50	48	0,5	923 020	923 023	923 028	923 024
COT 100	96	0,9	923 040	923 043	923 048	923 044

COT J

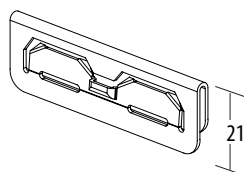

(mm)

	Hi mm	kg/m	GS	GC	304L	316L
COT J	-	-	923 050	-	-	923 054



Índice

23-26
Uniones

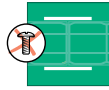

Uniones rápidas

23

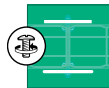

Uniones con tornillos

26

EDRN



EDRN CF30 - CF54 - CF105 - CF150 50 → 600 MM

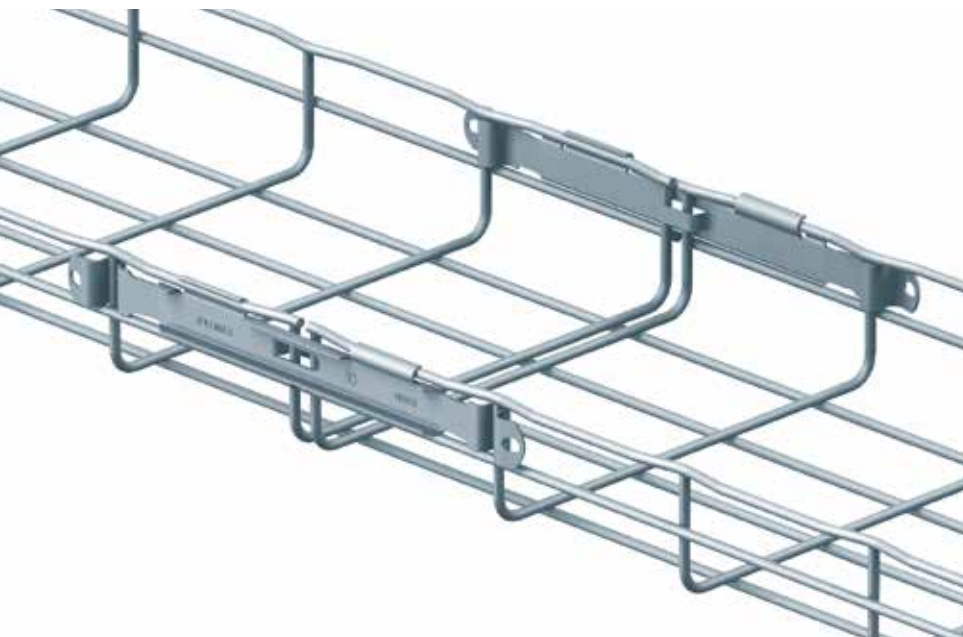

A =

B =

CF30 - CF54 - CF105 - CF150

(50 → 200 mm)

(300-400 mm)

(450 → 600 mm)



2x EDRN

2x EDRN

2x EDRN



-

1x EDRN o CEFAS

2x EDRN o CEFAS

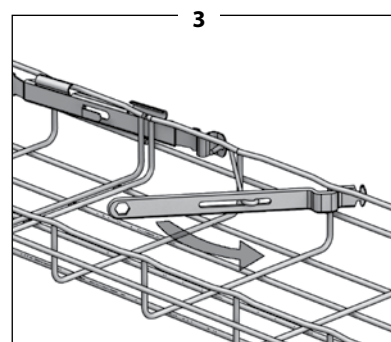
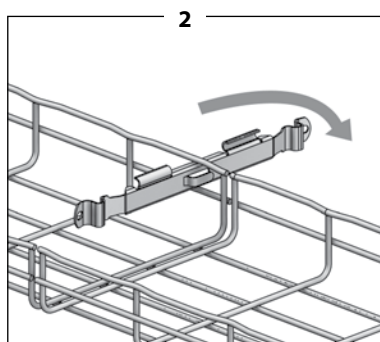
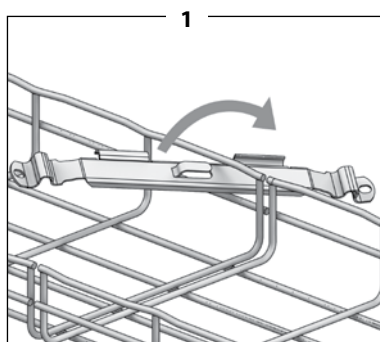

EDRN

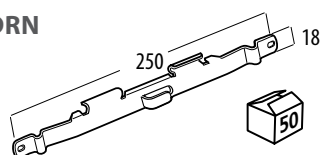

(mm)



		EZ	DC	304L	316L
EDRN	50	558 241	558 247	-	558 244
LLAVE EDRN	10	558 260	-	-	-

CEFAS

CEFAS  CF30 - CF54 - CF105 - CF150  100 → 600 MM

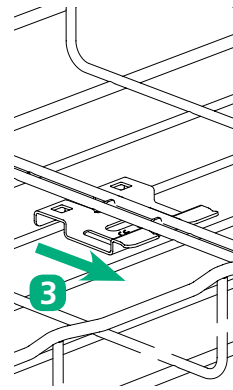
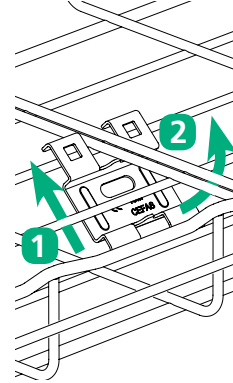

CEFAS

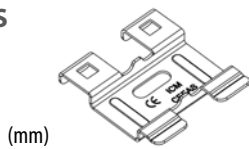

		GS	DC	304L	316L
CEFAS	50	558 410	558 417	-	558 414

FASLOCK



FASLOCK \updownarrow CF30 - CF54 - CF105 - CF150 \curvearrowright 100 \Rightarrow 600 MM

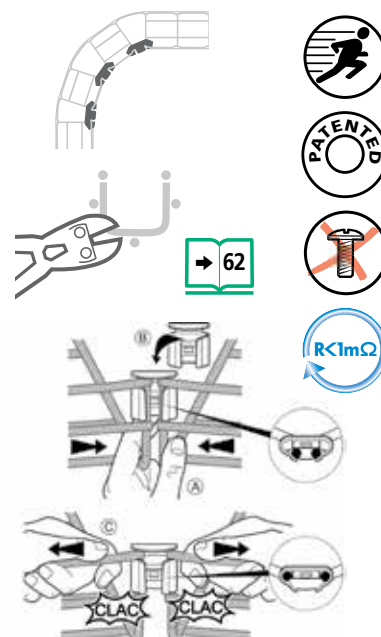
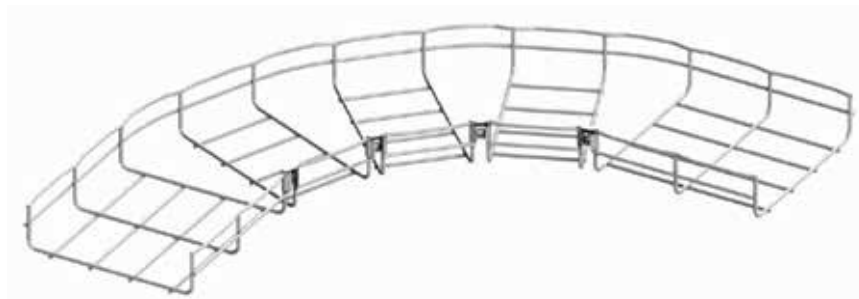

(mm)

FASLOCK S \Rightarrow \curvearrowright 100 \Rightarrow 200 MM

FASLOCK XL \Rightarrow \curvearrowright 300 \Rightarrow 600 MM

		GS	DC	304L	316L
FASLOCK S	25	558 340	558 347	-	558 344
FASLOCK XL	25	558 320	558 327	-	558 324

PA

PA \updownarrow CF30 - CF54 - CF105 \curvearrowright 50 \Rightarrow 600 MM

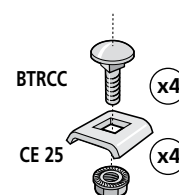
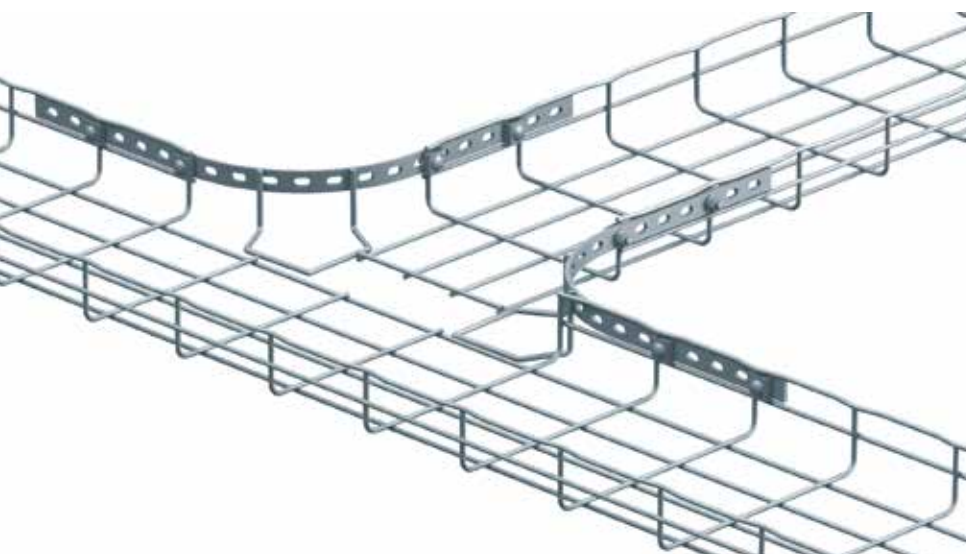

(mm)

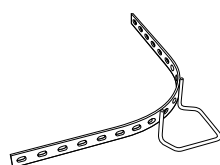

	H _i mm	\downarrow daN	EZ	GC	304L	316L
PA1	30	-	840 101	840 103	-	-
PA2	54	-	840 111	840 113	-	-
PA3	105	-	840 131	840 133	-	-

ED 275

ED 275  ~~CF50~~ - CF54 - CF105 - CF150  50 → 600 MM

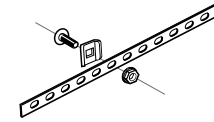
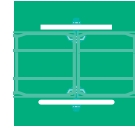
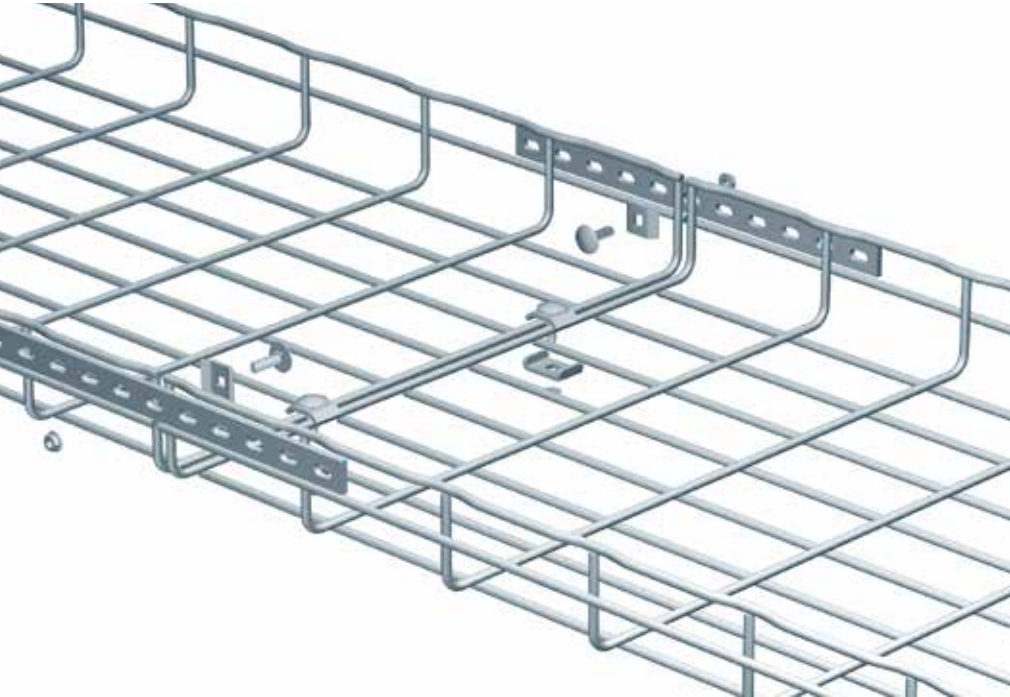

- BTRCC 1x
- CE 25 1x
- ED 275 1x

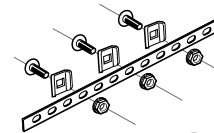

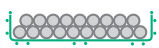

- BTRCC 3x
- CE 25 3x
- ED 275 1x





A =  

B =  

 CF54 - CF105 - CF150

 (50 mm)

 (100 → 200 mm)

 (300 → 600 mm)



2x CE 25 + BTRCC + ED 275

2x CE 25 + BTRCC + ED 275

2x CE 25 + BTRCC + ED 275



-

1x CE 25 + CE 30 + BTRCC

2x CE 25 + CE 30 + BTRCC

ED 275

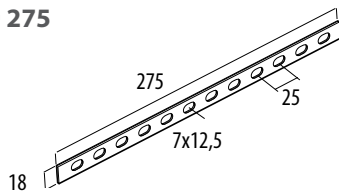

BTRCC



CE 25

(mm)

		EZ	GC	304L	316L
ED 275	50	558 221	558 223	558 228	558 224
			DC		
BTRCC 1/4"	50	941 084	-	-	941 059
BTRCC 6X20	100	-	801 017	801 018	-
CE 25	50	558 011	558 013	558 018	558 014

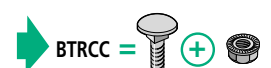

CE 25 / CE 30

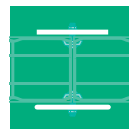

CE 25 - CE 30 CF30 - CF54 - CF105 - CF150 50 → 600 MM

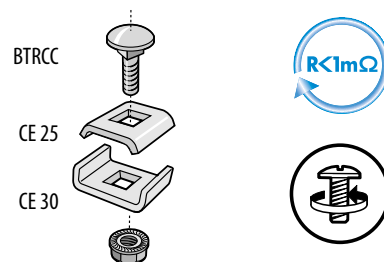
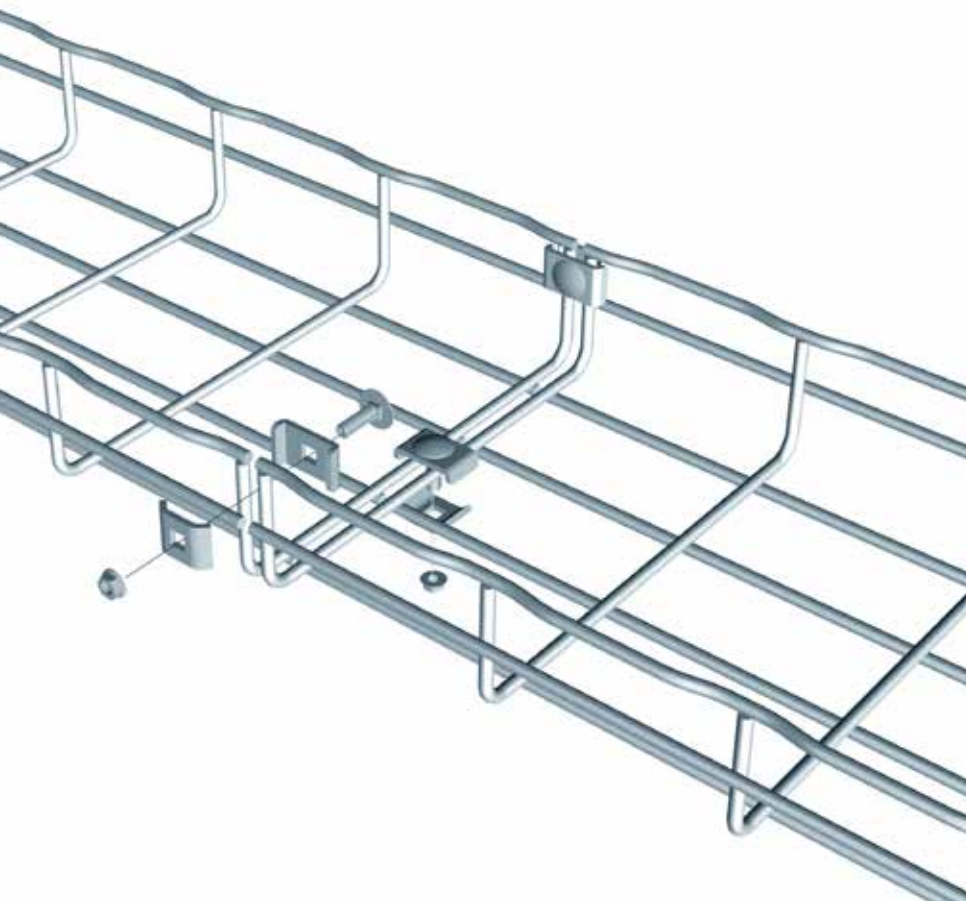

CF30 - CF54 - CF105 - CF150 - TXF35

(50 mm)

(100 → 200 mm)

(300 → 600 mm)



2x CE 25 + CE 30 + BTRCC

2x CE 25 + CE 30 + BTRCC

2x CE 25 + CE 30 + BTRCC



-

1x CE 25 + CE 30 + BTRCC

2x CE 25 + CE 30 + BTRCC

CE 25 - CE 30 BTRCC 6X20

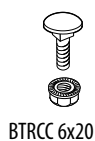
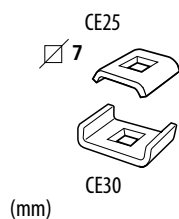

		EZ	DC	304L	316L
CE 25	50	558 011	558 013	558 018	558 014
CE 30	50	558 041	558 043	558 048	558 044
BTRCC 1/4"	50	941 084	-	-	941 059
BTRCC 6X20	100	-	801 017	801 018	-

IMPORTANCIA DEL TIPO Y DEL PUNTO DE UNIÓN

Para una optimización de la instalación, la elección de las uniones es tan importante como la de su emplazamiento en el tramo. Las uniones CABLOFIL® están concebidas y sometidas a prueba para prestaciones mecánicas y eléctricas elevadas.

Con el fin de sacar provecho de esto plenamente, conviene respetar las recomendaciones siguientes :

CASO TÍPICO APLICABLE PARA TODOS LOS SOPORTES

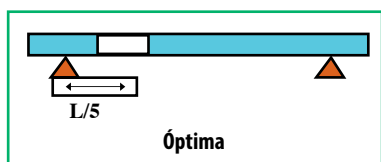

(100% de prestaciones)
Colocar la unión a L/5a es la mejor solución.

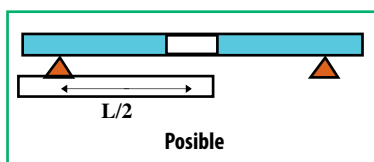

(70% de prestaciones)
El coeficiente a aplicar a la carga admisible si la unión está a L/2, es 0,7.

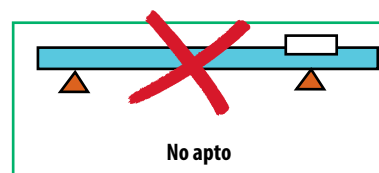

Jamás superponer la unión y el soporte.

CASO PARTICULAR : DISTANCIA CABLOFIL® 2 METROS (P2000)

Existe una configuración óptima para obtener separaciones entre soportes de 2 metros sin que las uniones se encuentren al nivel de los mismos o en medio de estos.

Para obtener este resultado, el primer tramo es voluntariamente limitado a 1,5 metros, luego los soportes son espaciados cada 2 metros. La distancia de cada unión al soporte más cercano ha de ser de 0,5 m, próxima a la situación ideal (0,4 m).

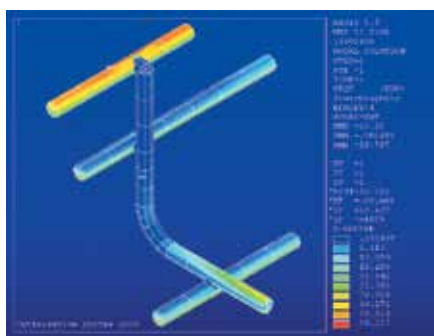
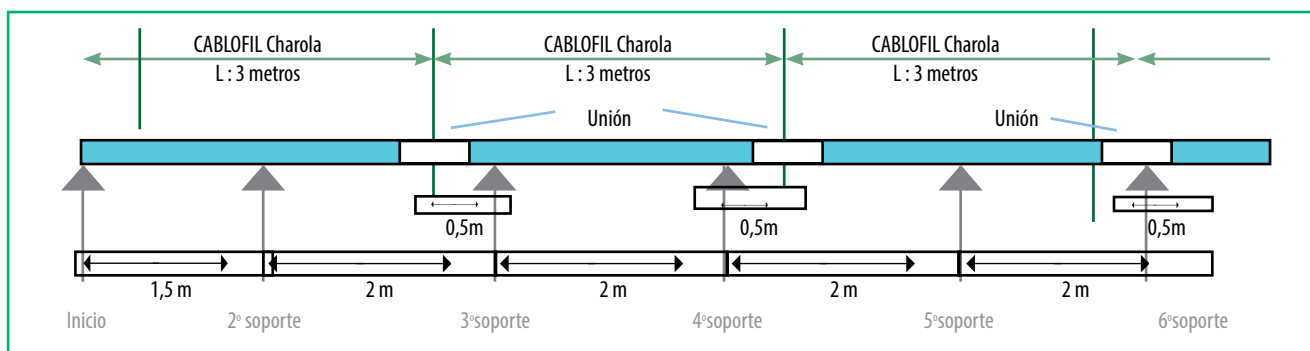

El respeto de esta configuración, asociado con la calidad y la penetración de los hilos en la soldadura, permite garantizar una distancia de 2 metros entre soportes en la gama estrella de CABLOFIL® (CF 54 de 50 mm a 500 mm de anchura).



Índice

30-34
Instalación mural



Cargas ligeras

30



Cargas medias

31



Cargas pesadas

33



Sobre cantos o subida vertical

34

UC 50

UC 50  CF30 - CF54  50 MM



UC 50

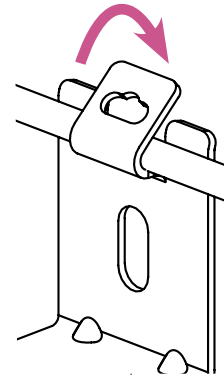
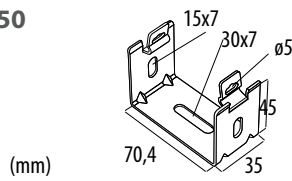

BTRCC  x1

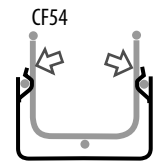
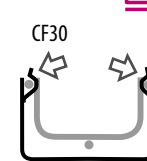
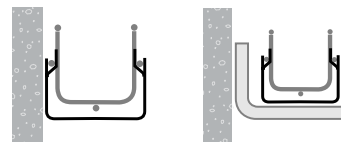

	 daN	GS	GC	304L	316L
UC 50	12	586 040	586 043	586 048	586 044

CM 50XL

CM 50XL  CF54  50 → 100 MM

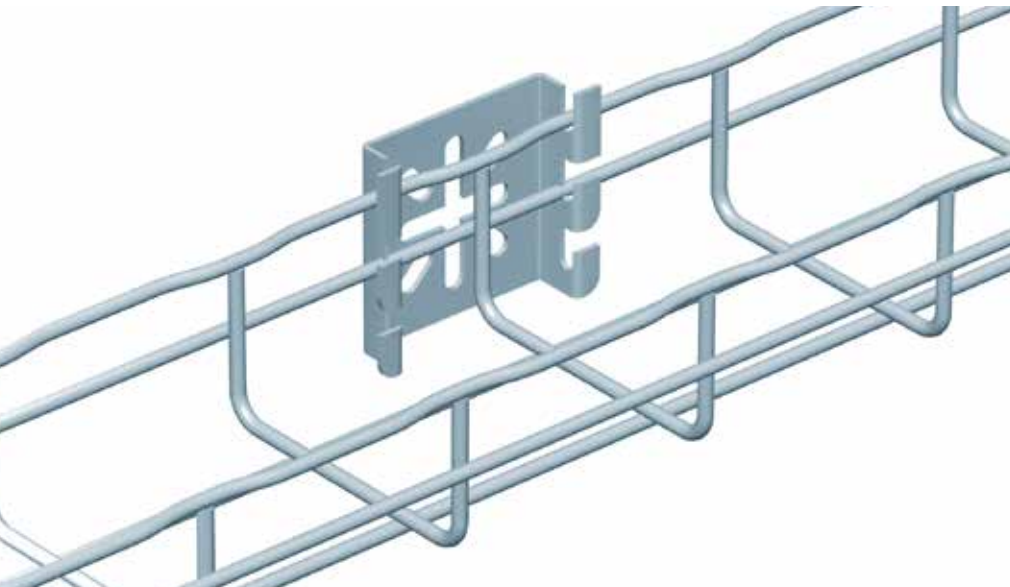

CM 50XL

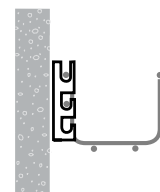
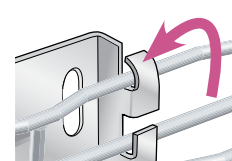
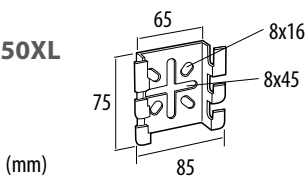

	 daN	GS	GC	304L	316L
CM50XL	100	586 130	586 133	586 138	586 134

CSN



CSN CF30 - CF54 100 → 300 MM

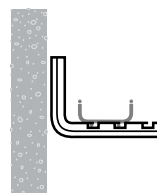
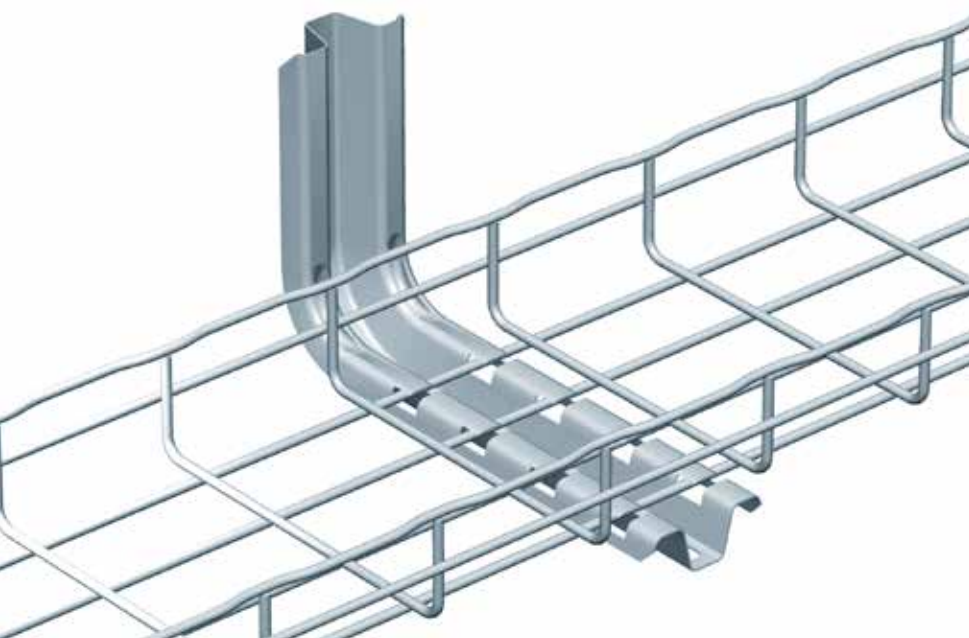

CSN

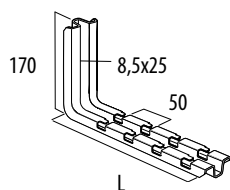

(mm)

	L mm	H daN	GS	GC	304L	316L
CSN 100	178	30	556 100	556 103	556 108	556 104
CSN 150	228	110	556 110	556 113	556 118	556 114
CSN 200	278	85	556 120	556 123	556 128	556 124
CSN 300	378	73	556 130	556 133	556 138	556 134

CU 100 → 300

CU 100→300 CF30 - CF54 - CF105 - CF150 100 → 300 MM

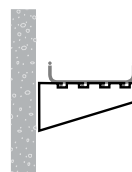
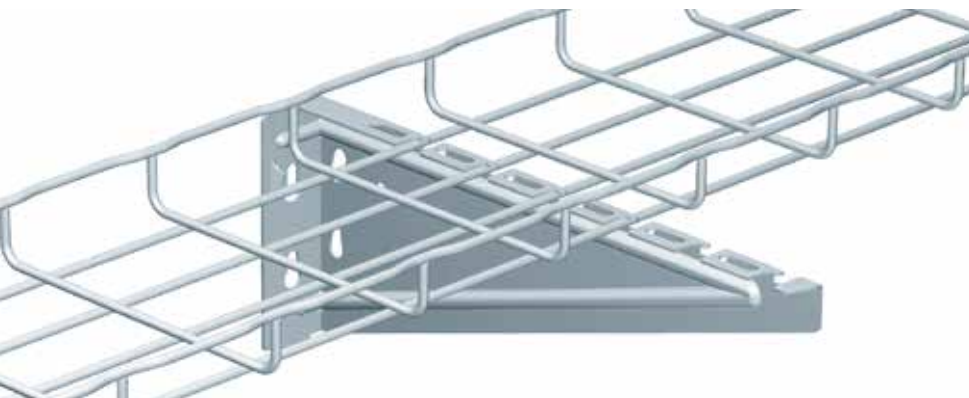

CU 100→300

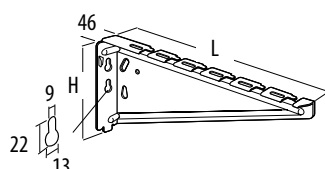

(mm)

	L mm	Hi mm	H daN	GS	GC	304L	316L	
CU 100	157	85	30	45	557 410	557 413	-	557 414
CU 150	207	124	70	135	557 420	557 423	-	557 424
CU 200	257	139	80	110	557 430	557 433	-	557 434
CU 300	357	139	80	120	557 440	557 443	-	557 444

CU 400 → 600



CU 400 → 600 CF30 - CF54 - CF105 - CF150 400 → 600 MM

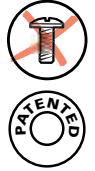

FAST
FAST ASSEMBLING SYSTEM

CU 400 → 600

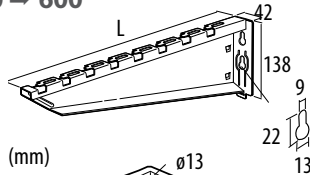

EDF

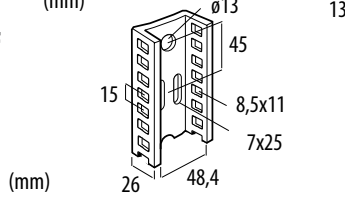

	L mm	Hi mm			GS	GC	304L	316L
CU 400	457	138	105	115	557 450	557 453	-	557 454
CU 500	557	138	220	160	557 460	557 463	-	557 464
CU 600	657	138	200	145	557 470	557 473	-	557 474

	L mm	Hi mm			GS	GC	304L	316L
EDF 2000	2000				561 010	561 013	561 018	561 014

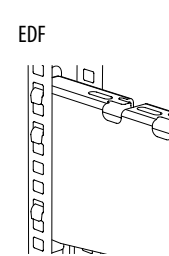
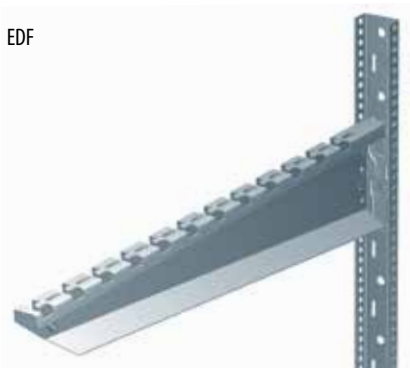

UNICANAL

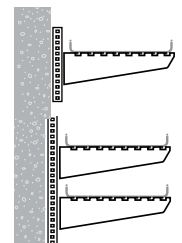
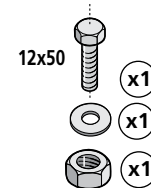

C - SI

C - SI CF30 - CF54 - CF80 100 → 300 MM

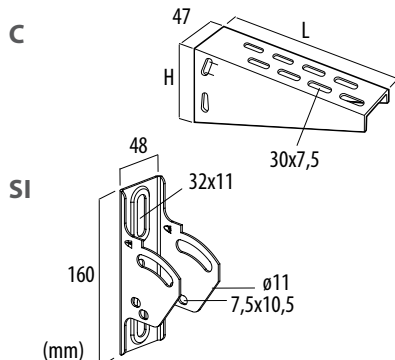
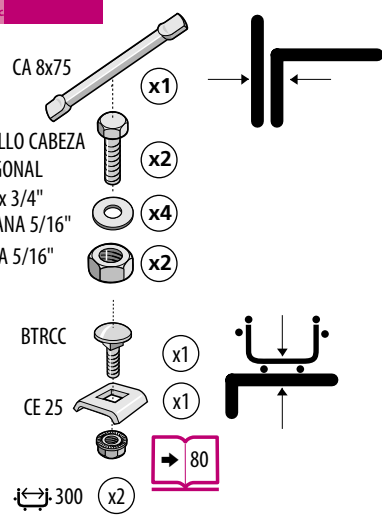
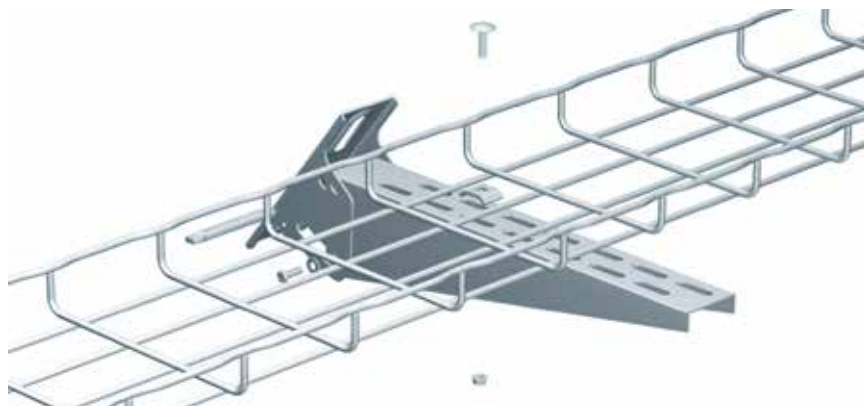

	L mm	Hi mm	daN	GS	GC	304L	316L
C 100	140	83	260	557 010	557 013	-	-
C 200	220	83	210	557 020	557 023	-	-
C 300	340	84	190	557 030	557 033	-	-
C 400	460	84	170	557 040	557 043	-	-
C 500	555	96	160	557 050	557 053	-	-
C 600	640	108	150	557 060	557 063	-	-
SI			12	561 100	561 103	-	-

C41S

C41S CF30 - CF54 - CF105 - CF150 100 → 600 MM

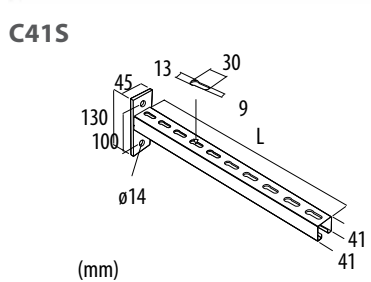
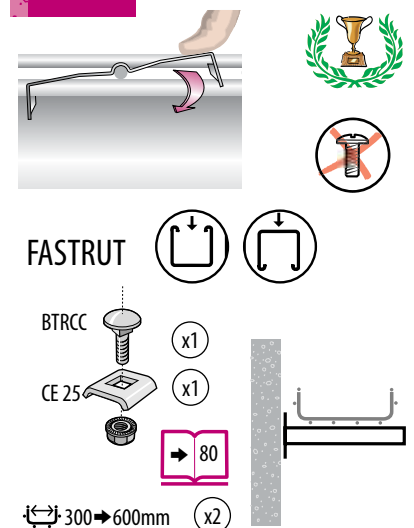
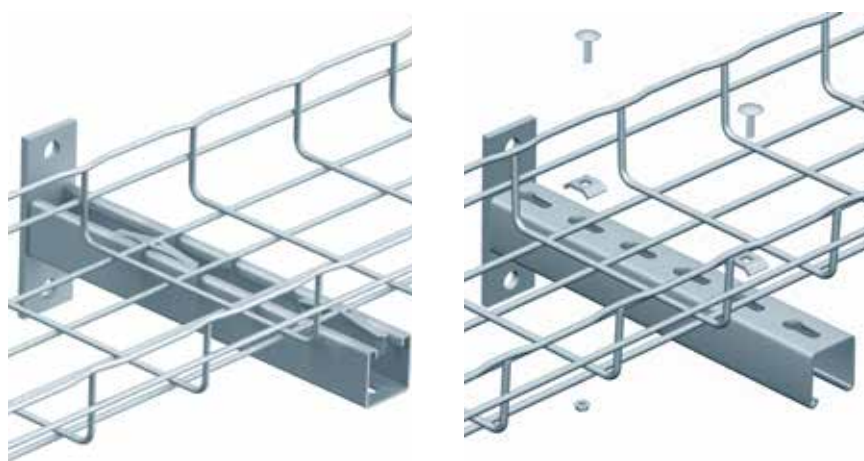

	L mm	Hi mm	daN	GS	GC	304L	316L
C41S150	150	130	500	-	595 013	-	595 014
C41S200	200	130	450	-	595 023	-	595 024
C41S300	300	130	340	-	595 033	-	595 034
C41S400	400	130	270	-	595 043	-	595 044
C41S500	500	130	270	-	595 053	-	595 054
C41S600	600	130	220	-	595 063	-	595 064

R55

R55 CF30 - CF54 - CF105 100 → 600 MM

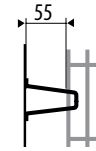

400 → 600mm (x3)

200 → 300mm (x2)



FASLOT
FAST ASSEMBLY SYSTEM

R55

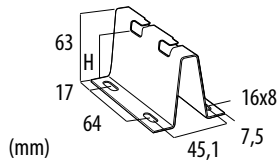

	Hi mm	\downarrow daN	GS	DC	304L	316L
R55	55	45	586 080	586 083	-	586 084

UC 50

UC 50 CF30 - CF54 50 MM

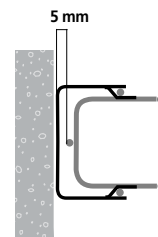
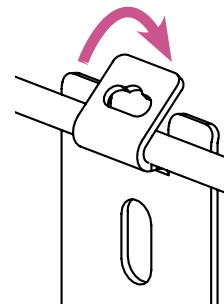
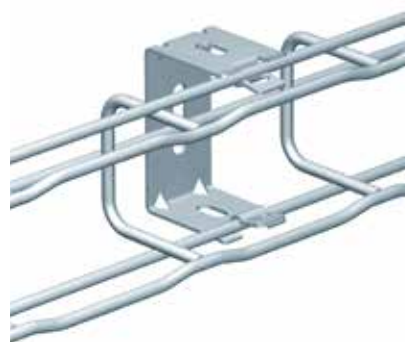

UC 50

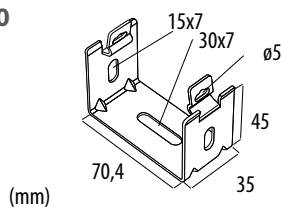

	\downarrow daN	GS	GC	304L	316L
UC 50	12	586 040	586 043	586 048	586 044

CM 50XL



CM 50XL CF30 - CF54 100 → 600 MM

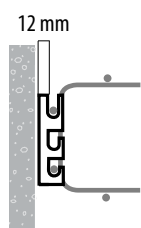
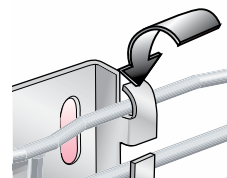
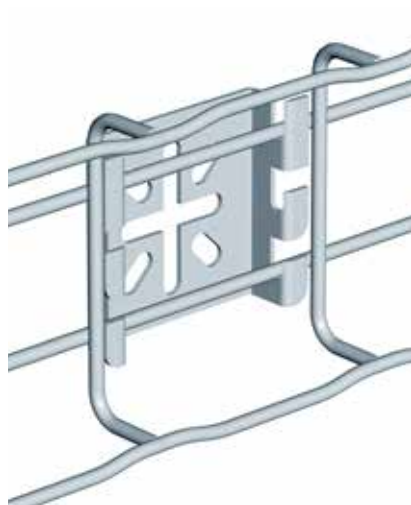

CM 50XL

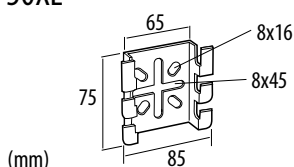

	\downarrow daN	GS	GC	304L	316L
CM50XL	100	586 130	586 133	586 138	586 134

RCSN

RCSN CF30 - CF54 - CF105 100 → 600 MM

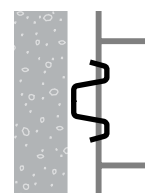
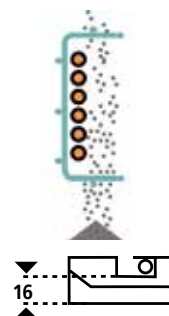
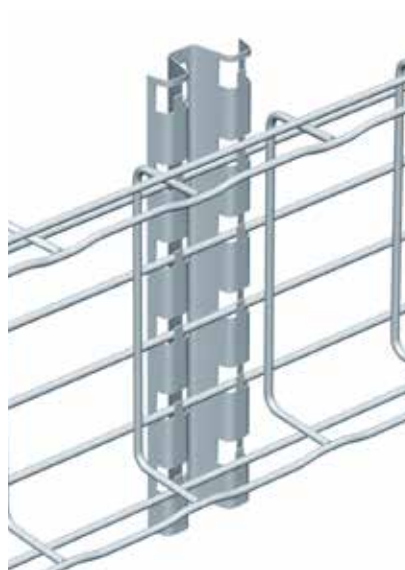

FAS
FAST ASSEMBLY SYSTEM

RCSN

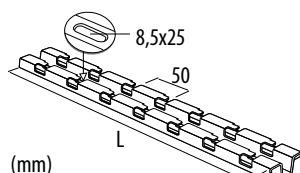

	L mm	\downarrow daN	GS	DC	304L	316L
RCSN 3000	3000	100	014 030	014 033	014 038	014 034



Índice

37-44
Instalación
en el techo



Suspensión central

37



Montaje en lira

40



En trapecio

40



Soportes colgantes medianos

42



Soportes colgantes pesados

44

SF 50/100

SF 50/100 CF30 - CF54 50 - 100 MM



SF 50

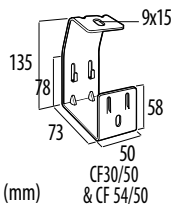

SF 100

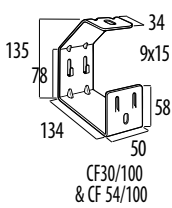

		\downarrow FL daN	GS	GC	304L	316L
SF 50	1	30	586 140	586 143	-	586 144
SF 100	1	26	586 100	586 103	-	586 104

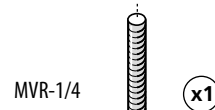
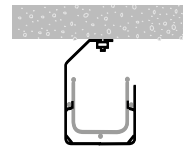
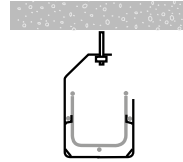

CEQ/UC50

CEQ/UC50 CF30 - CF54 50 MM

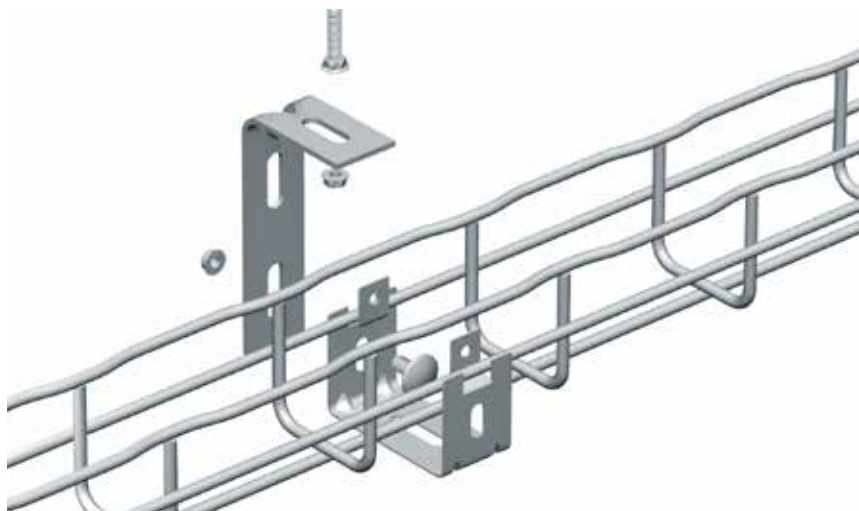

CEQ

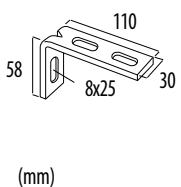

UC50

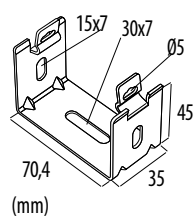

		\downarrow FL daN	GS	GC	304L	316L
CEQ 100	1	12	557 300	557 303	-	557 304
UC 50	1	12	586 040	586 043	586 048	586 044

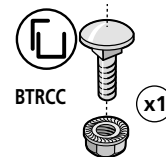
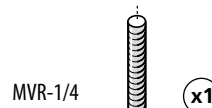
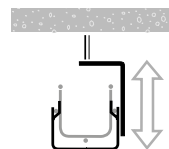

SAS



SAS CF30 - CF54 100 → 150 MM

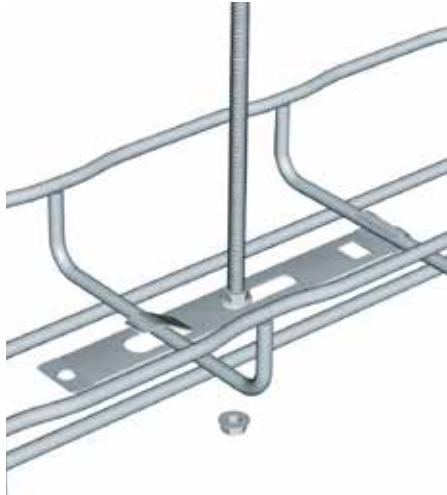

SAS

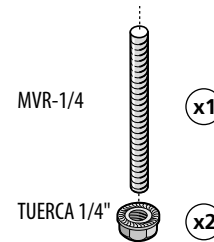
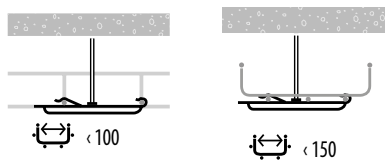
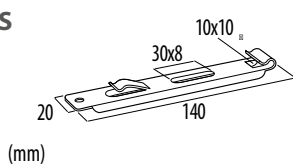

		daN	GS	GC	304L	316L
SF 50	1	60	586 031	586 037	-	-

CE40 - CM50XL

CE40 - CM50XL CF30 - CF54 100 → 200 MM

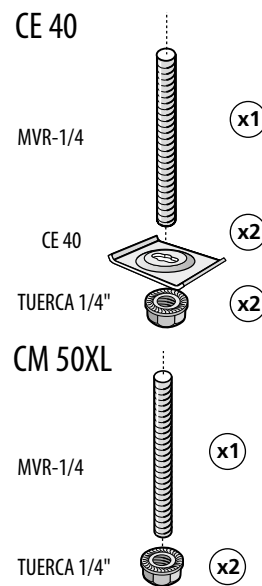
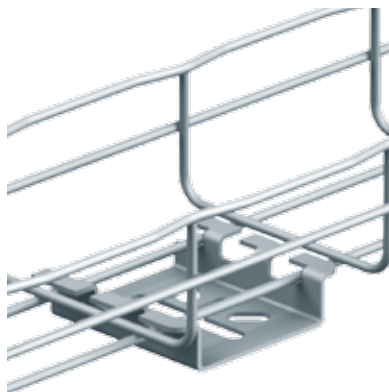
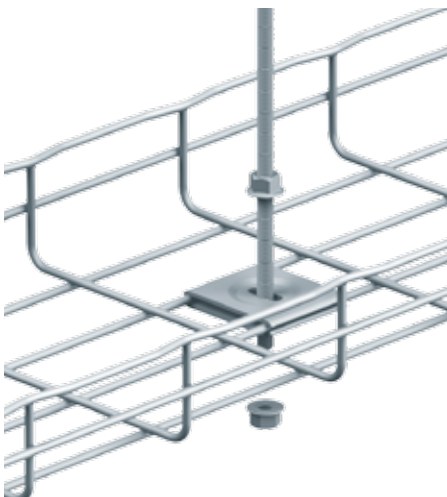

CE 40

CM 50XL

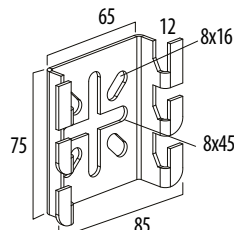
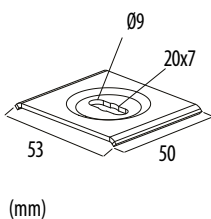

		daN	GS	GC	304L	316L
CE 40	25	100	558 051	558 053	558 058	558 054

	daN	GS	GC	304L	316L
CM 50XL	100	586 130	586 133	586 138	586 134

SCF



SCF CF30 - CF54 200 → 600 MM

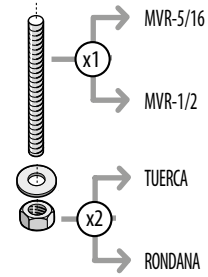
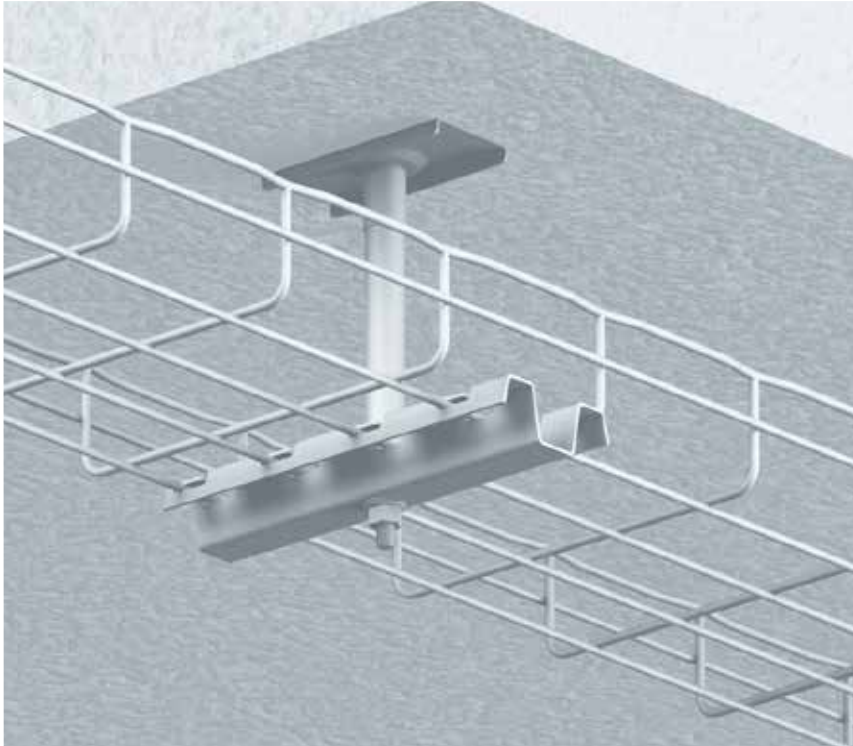

FAS **LOT**
FAST ASSEMBLING SYSTEM

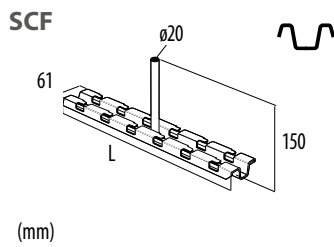
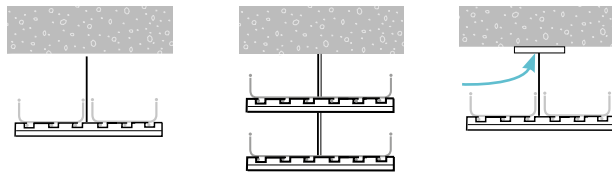

	L mm	$\frac{F_d}{F_c}$ daN	$\frac{F_d}{F_c}$ daN	GS	GC	304L	316L
SCF 200	194	200	37	586 200	-	-	-
SCF 300	294	160	29	586 300	-	-	-
SCF 400	394	141	23	586 400	-	-	-
SCF 450	444	130	20	586 450	-	-	-
SCF 500	494	121	20	586 500	-	-	-
SCF 600	594	99	19	586 600	-	-	-

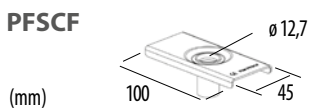

	L mm	$\frac{F_d}{F_c}$ daN	$\frac{F_d}{F_c}$ daN	GS	GC	304L	316L
PFSCF	100	-	-	586 210	-	-	-

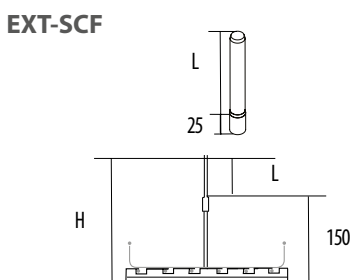

	L mm	H mm		GS	GC	304L	316L
EXT-SCF 50	50	200	-	586 810	-	-	-
EXT-SCF 100	100	250	-	586 820	-	-	-
EXT-SCF 150	150	300	-	586 830	-	-	-

AS



AS CF30 - CF54 - CF105 100 → 600 MM

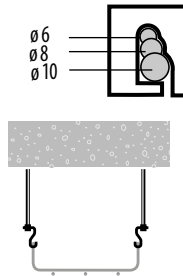
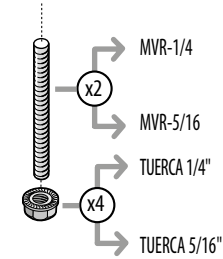

AS

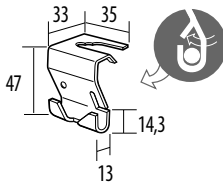

(mm)

		daN	GS	GC	304L	316L
AS	50	100	586 020	586 023	-	586 024

CSNC



CSNC CF30 - CF54 - CF105 100 → 300 MM

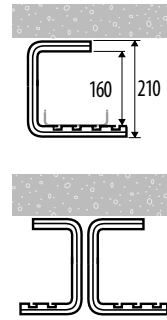

FASLOT
FAST ASSEMBLING SYSTEM

CSNC

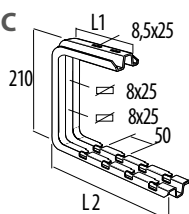

(mm)

	L1 mm	L2 mm	daN	GS	GC	304L	316L
CSNC 100	170	178	120	556 300	556 303	-	556 304
CSNC 150	170	228	100	556 310	556 313	-	556 314
CSNC 200	170	278	80	556 320	556 323	-	556 324
CSNC 300	288	378	70	556 330	556 333	-	-
CSNC 400	288	478	48	556 340	556 343	-	-
CSNC 450	288	528	44	556 350	556 353	-	-

RCSN



RCSN \updownarrow CF30 - CF54 - CF105 \leftrightarrow 100 \rightarrow 600 MM

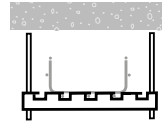
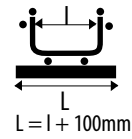
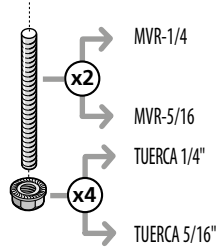

RCSN

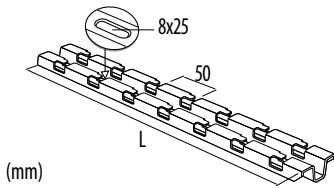

(mm)

	L mm	F daN	GS	GC	304L	316L
RCSN 3000	3000	100	014 030	014 033	014 038	014 034

FASTRUT 41

FASTRUT 41 \updownarrow CF30 - CF54 - CF105 - CF150 \leftrightarrow 100 \rightarrow 600 MM

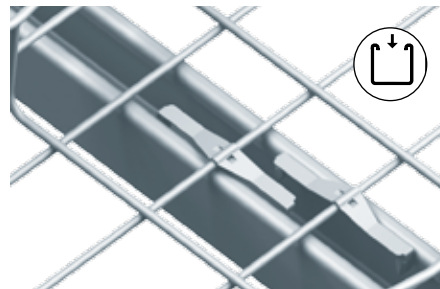
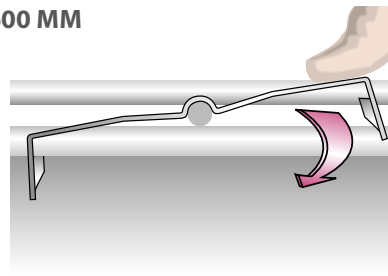

FASTRUT FS41

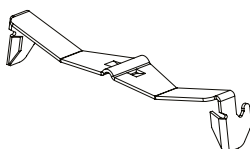

	L	L mm	GS	GC	304L	316L
FS41	50	73	-	599 007	-	599 004

EDF

EDF CF30 - CF54 - CF105 100 → 600 MM

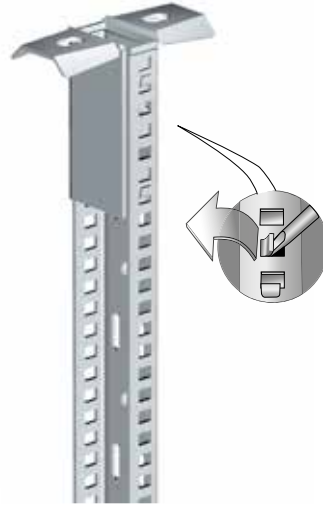

CSN

TORNILLO CABEZA
HEXAGONAL
5/16" x 3/4"



RONDANA 5/16"



TUERCA 5/16"



CU 50 → 300

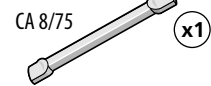

FASLOT
FAST ASSEMBLY SYSTEM

CU 400 → 600

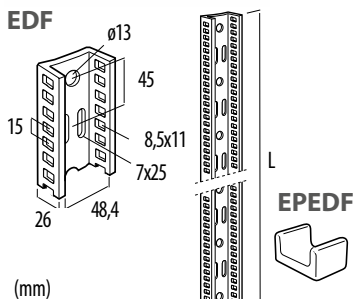
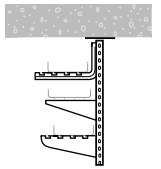
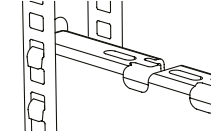

	L mm	Hi mm	↓ daN	GS	GC	304L	316L
EDF 2000	2000	-	-	561 010	561 013	561 018	561 014
EPEDF (PVC)	-	-	-	559 615	-	-	-

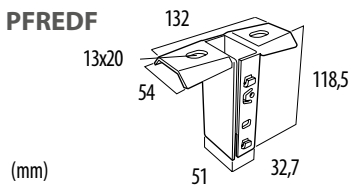

	L mm	Hi mm	↻ daN.m	GS	GC	304L	316L
PFREDF	-	-	18	561 080	-	-	561 084

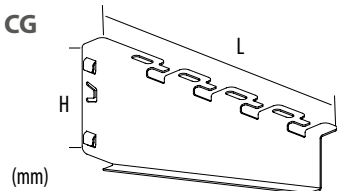

	L mm	Hi mm	↓ daN	GS	GC	304L	316L
CG 100	153	73	55	557 920	-	-	557 924
CG 150	203	73	50	557 930	-	-	557 934
CG 200	253	87	65	557 940	-	-	557 944
CG 300	353	87	70	557 950	-	-	557 954
CG 400	453	103	100	557 960	-	-	557 964
CG 500	553	103	85	557 970	-	-	557 974

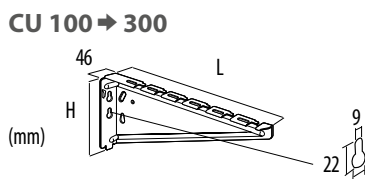

	L mm	Hi mm	↓ daN	GS	GC	304L	316L
CU 100	157	85.1	50	557 410	557 413	-	557 414
CU 150	207	124.1	120	557 420	557 423	-	557 424
CU 200	257	139.1	110	557 430	557 433	-	557 434
CU 300	357	139.1	120	557 440	557 443	-	557 444
CU 400	457	138	115	557 450	557 453	-	557 454
CU 500	557	138	165	557 460	557 463	-	557 464
CU 600	657	138	145	557 470	557 473	-	557 474

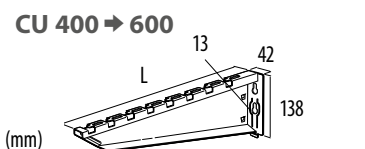

UNICANAL



UNICANAL CF30 - CF54 - CF105 100 → 300 MM

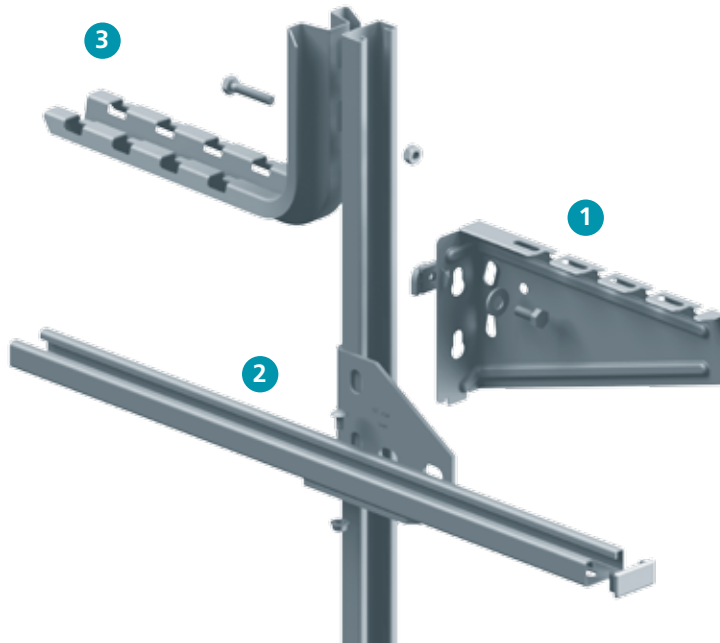

FASLOT
FAST ASSEMBLY SYSTEM

- 1 2
TORNILLO CABEZA
HEXAGONAL
5/16" x 3/4"
RONDANA 5/16" x2
UTR-5/16"



- 3
TORNILLO CABEZA
HEXAGONAL
5/16" x 3/4"
RONDANA 5/16"
TUERCA 5/16" x2
TORNILLO CABEZA
REDONDA
5/16" x 3/4"
TUERCA 5/16" x2

UNICANAL

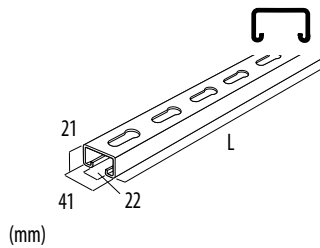

	L mm	H mm	F _d daN	GS	GC	304L	316L
UNICANAL PERFORADO	3050	-	-	UNF-42-P	-	-	-

CSN INTERFAS

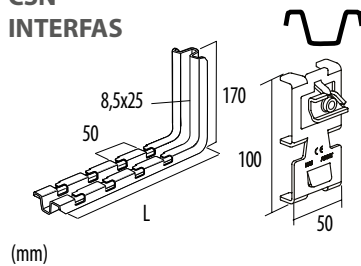

	L mm	F _d daN	GS	GC	304L	316L
CSN 100	178	30	556 100	556 103	556 108	556 104
CSN 150	228	110	556 110	556 113	556 118	556 114
CSN 200	278	85	556 120	556 123	556 128	556 124
CSN 300	378	73	556 130	556 133	556 138	556 134
INTERFAS	100	-	557 800	557 803	-	557 804

CU 100 → 300

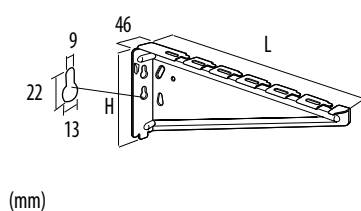

	L mm	H mm	F _d daN	GS	GC	304L	316L
CU 100	157	85	50	557 410	557 413	-	557 414
CU 150	207	124	120	557 420	557 423	-	557 424
CU 200	257	139	110	557 430	557 433	-	557 434
CU 300	357	139	120	557 440	557 443	-	557 444

UNICANAL



UNICANAL CF30 - CF54 - CF105 - CF150 50 → 600 MM

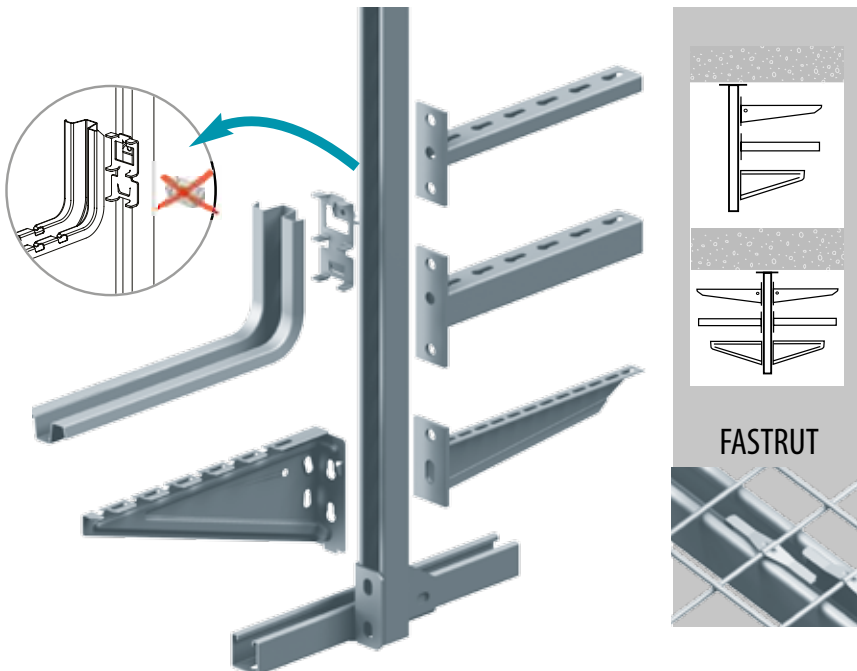

1 2
TORNILLO CABEZA HEXAGONAL 5/16" x 3/4"
RONDANA 5/16" x2
UTR-5/16"

TORNILLO CABEZA HEXAGONAL 5/16" x 3/4"
RONDANA 5/16"
TUERCA 5/16" x2

TORNILLO CABEZA REDONDA 5/16" x 3/4"
TUERCA 5/16" x2

FASL[®] FAST ASSEMBLY SYSTEM

UNICANAL

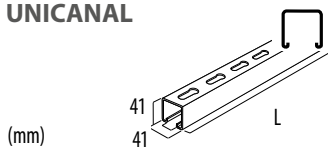

	L mm		F _d daN	GS	GC	304L	316L
UNICANAL PERFORADO	3050	-	-	UNF-44-P	-	-	-

CSN INTERFAS

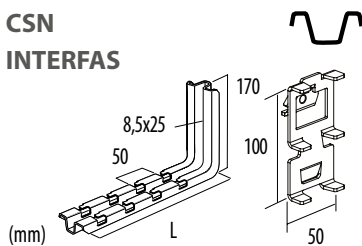

	L mm		F _d daN	GS	GC	304L	316L
CSN 100	178	-	30	556 100	556 103	556 108	556 104
CSN 150	228	-	110	556 110	556 113	556 118	556 114
CSN 200	278	-	85	556 120	556 123	556 128	556 124
CSN300	378	-	73	556 130	556 133	556 138	556 134

INTERFAS	100	-	-	557800	557803	-	-
-----------------	-----	---	---	--------	--------	---	---

C41S

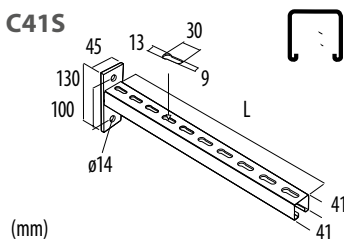

	L mm		F _d daN	GS	GC	304L	316L
C41S150	150	-	500	-	595 013	-	595 014
C41S200	200	-	450	-	595 023	-	595 024
C41S300	300	-	340	-	595 033	-	595 034
C41S400	400	-	270	-	595 043	-	595 044
C41S500	500	-	270	-	595 053	-	595 054
C41S600	600	-	220	-	595 063	-	595 064

CU 400 → 600

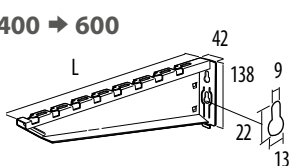

	L mm	H _i mm	F _d daN	GS	GC	304L	316L
CU 400	457	138	115	557 450	557 453	-	557 454
CU 500	557	138	165	557 460	557 463	-	557 464
CU 600	657	138	155	557 470	557 473	-	557 474

SU21

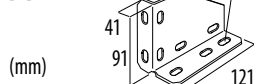

	L mm	H _i mm	F _d daN.m	GS	GC	304L	316L
SU41	-	-	35	595 340	-	-	-



Índice

<p>46-59 Otras soluciones</p>		<p>Instalación en el suelo</p>	<p>46</p>
		<p>Montaje en falso suelo</p>	<p>48</p>
		<p>Accesorios para la industria de alimentos</p>	<p>52</p>
		<p>Instalación en estructura metálica</p>	<p>53</p>
		<p>Soportes de piezas especiales y accesorios para data</p>	<p>55</p>
		<p>EZPath™ FIRE RATED PATHWAY</p>	<p>59</p>

CM 50XL

CM 50XL CF30 - CF54 - CF105 - CF150 100 → 600 MM

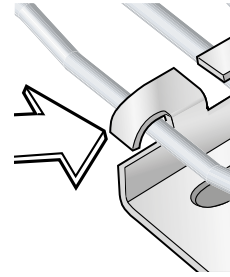
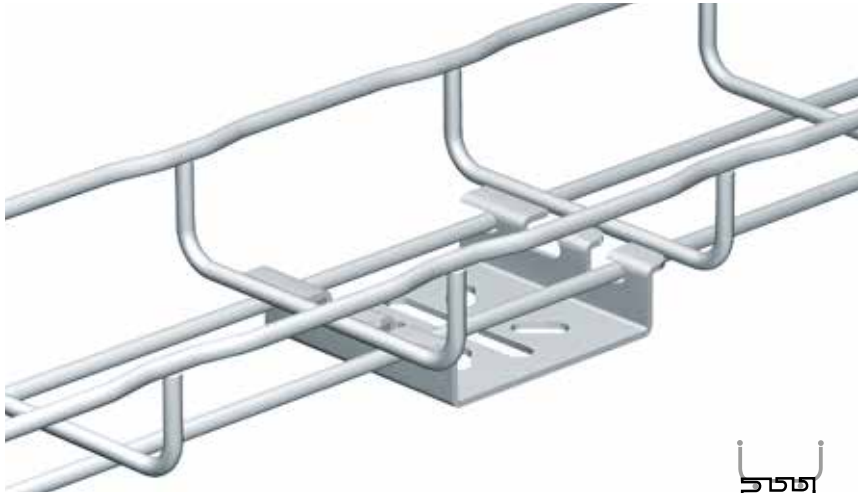

CM 50XL

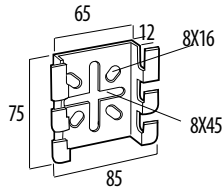

(mm)

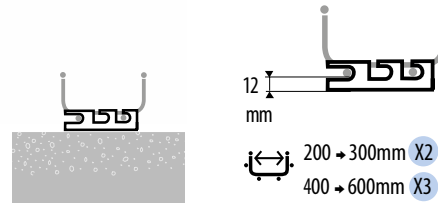

	daN	GS	GC	304L	316L
CM50XI	100	586 130	586 133	586 138	586 134

RCSN

RCSN CF30 - CF54 - CF105 - CF150 100 → 600 MM

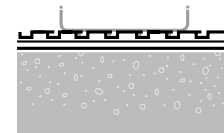
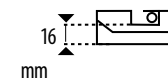
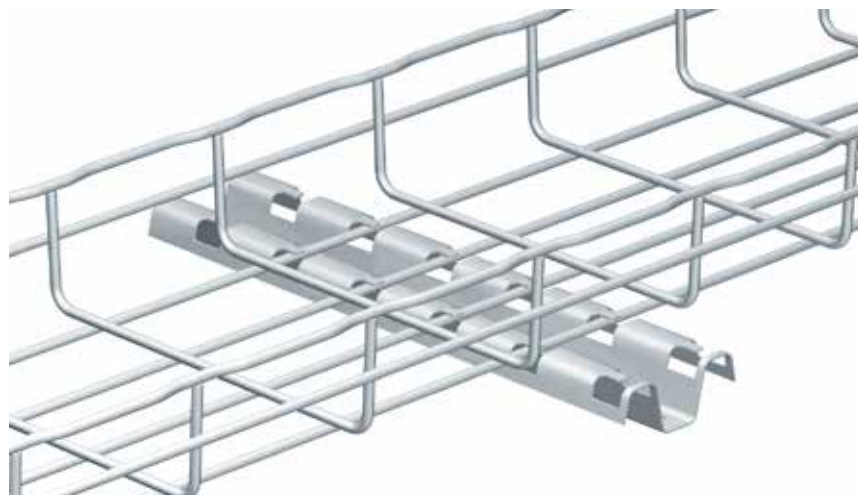

FASLOT
FAST ASSEMBLING SYSTEM

RCSN

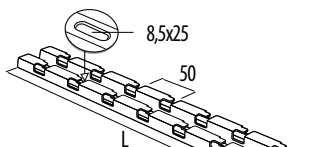

(mm)

	L mm	daN	GS	GC	304L	316L
RCSN 3000	3000	100	014 030	014 033	014 038	014 034

R55

R55 CF30 - CF54 - CF105 - CF150 100 → 600 MM

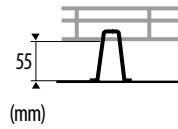
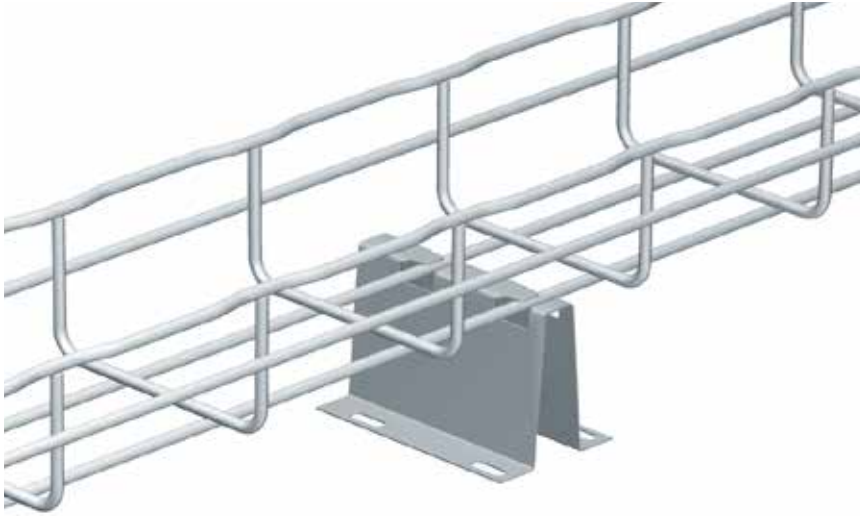

FAS^{LOT}
FAST ASSEMBLING SYSTEM

200 → 300mm X2
400 → 600mm X3

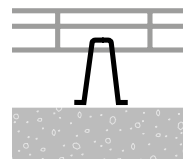

R55

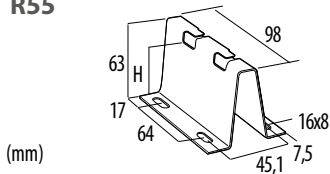

	H mm	F _L daN	GS	GC	304L	316L
R55	55	150	586 080	586 083	-	586 084

FTX

FTX CF30 - CF54 - CF105 100 → 600 MM

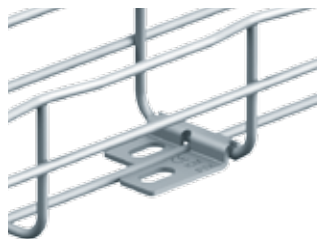
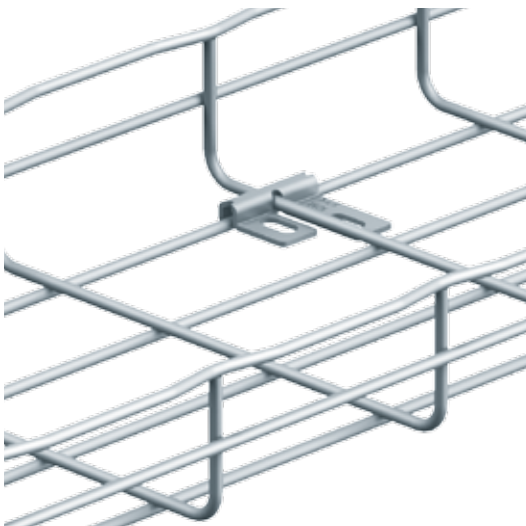

→ CF30/50 & CF54/50

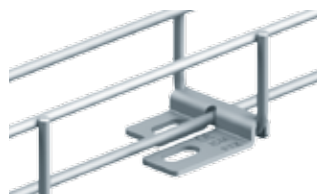

→ TXF35

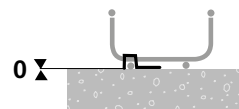

200 → 300mm X2
400 → 600mm X3

FTX

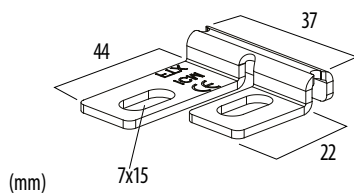

	GS	GC	304L	316L
FTX	586 180	586 183	-	586 184

UC 50



UC 50 \updownarrow CF30 - CF54 \leftrightarrow 50 MM

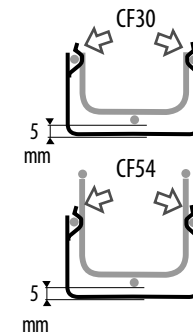
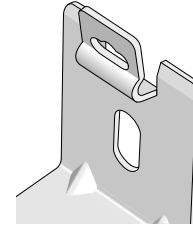
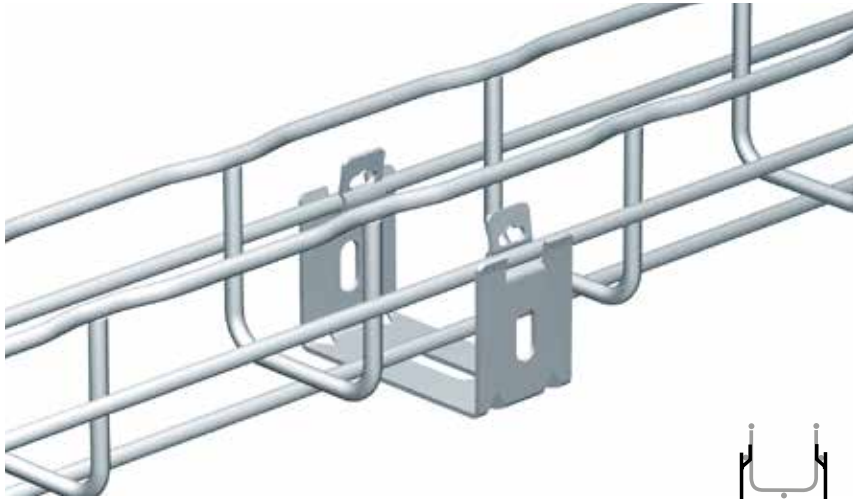

UC 50

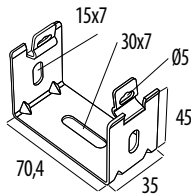

(mm)

	\downarrow daN	GS	GC	304L	316L
UC 50	12	586 040	586 043	586 048	586 044

UFS 150



UFS 150 \updownarrow CF30 - CF54 - CF105 - CF150 \leftrightarrow 100 → 600 MM

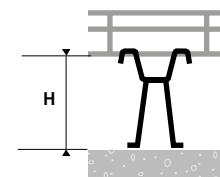
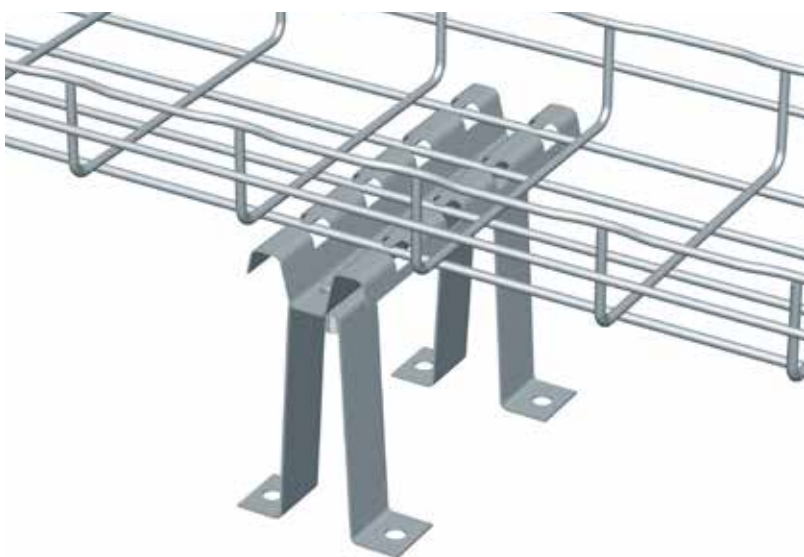

FASLOT
FAST ASSEMBLING SYSTEM

\leftrightarrow 100 → 300mm X1
 \leftrightarrow 450 → 600mm X2

UFS 150

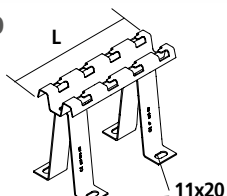

(mm)

	L mm	H mm	\downarrow daN	GS	GC	304L	316L
UFS 150 / 200	200	150	-	942 354	-	-	-

UFC



UFC \updownarrow CF30 - CF54 - CF105 - CF150 \leftrightarrow 100 \rightarrow 600 MM

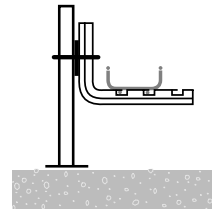

FAS^LOT
FAST ASSEMBLY SYSTEM

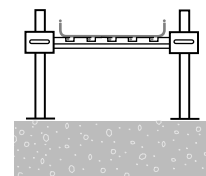
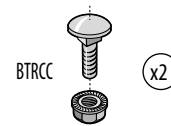
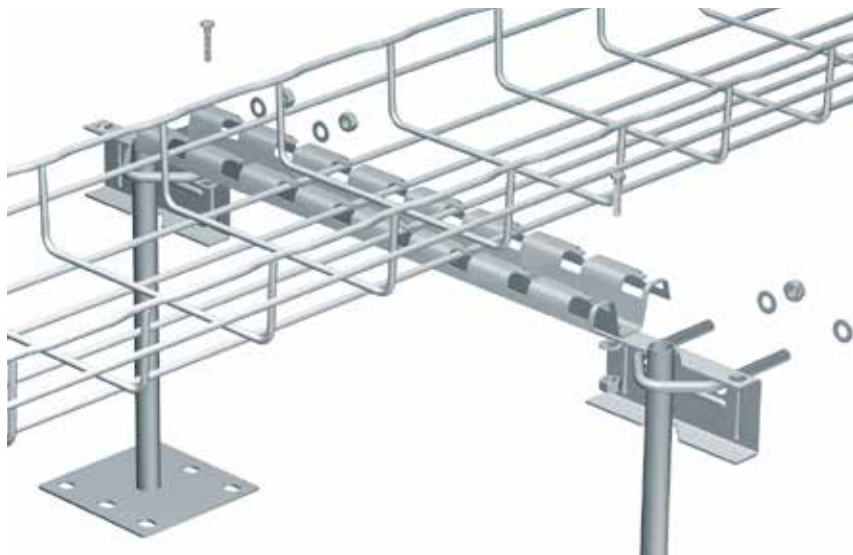

FAS^LOT
FAST ASSEMBLY SYSTEM

UFC

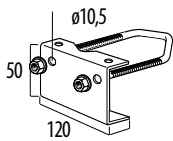

(mm)

	L1 mm	↓ daN	GS	GC	304L	316L
UFC	-	-	559 220	941 287	-	-

CSN

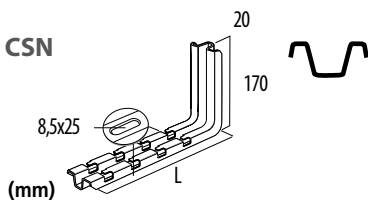

(mm)

	L mm	↓ daN	GS	GC	304L	316L
CSN 100	178	30	556 100	556 103	556 108	556 104
CSN 150	228	110	556 110	556 113	556 118	556 114
CSN 200	278	85	556 120	556 123	556 128	556 124
CSN 300	378	73	556 130	556 133	556 138	556 134

RCSN

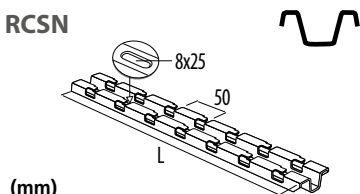

(mm)

	L1 mm	↓ daN	GS	GC	304L	316L
RCSN 3000	3000	-	014 030	014 033	014 038	014 034

PARTES Y ACCESORIOS PARA INSTALACIÓN EN EL SUELO



DF

DF CF30 - CF54 - CF105 - CF150 100 → 600 MM



	GS	GC	304L	316L
DF	561 060	561 063	-	561 064

CU 100 - 300

CU 100 - 300 CF30 - CF54 - CF105 - CF150 100 → 600 MM

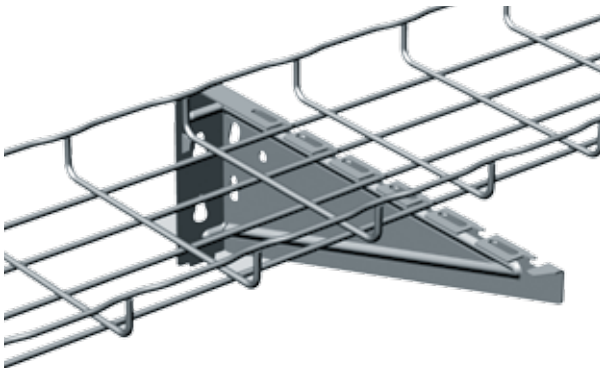

	L1 mm	H1 mm	GS	GC	304L	316L
CU 100	157	85	557 410	557 413	-	557 414
CU 150	207	124	557 420	557 423	-	557 424
CU 200	257	139	557 430	557 433	-	557 434
CU 300	357	139	557 440	557 443	-	557 444

UFS PARTES Y ACCESORIOS PARA INSTALACIÓN EN EL SUELO



UFS Kits de soporte

Barra transversal – Esta barra para trabajos pesados está diseñada con el sistema de instalación rápido (FAS) y patentado de Cablofil, que asegura todas las charolas sin necesidad de tornillos extra.

Patas de soporte (EDF) – Cuenta con múltiples orificios de montaje para una gran variedad de instalaciones.

Clip fijador - Clips de metal corrugado que aseguran las charolas a las patas sin necesidad de herramientas.

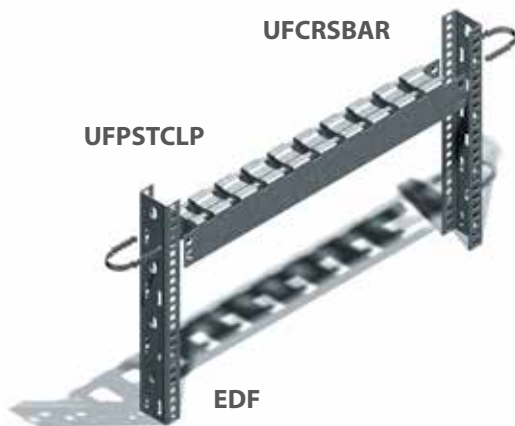

		H mm		W mm		L mm		PG**
UFS Kits de soporte		pul	mm	pul	mm	pies	mm	
UFSUPKIT100*	1	3.5	100	22	550	-	-	942 918
UFSUPKIT200*	1	7	200	22	550	-	-	942 919
UFSUPKIT300*	1	10.6	300	22	550	-	-	942 920
UFSUPKIT400*	1	14	400	22	550	-	-	942 921
UFSUPKIT600*	1	21.2	600	22	550	-	-	942 922
Componentes del kit pueden ser ordenados individualmente								
Barra transversal								
UFCRSBARPG	1	2.4	60	22	550	-	-	589 010
Patas								
EDF100PG	1	3.5	90	-	-	-	-	561 320
EDF200PG	1	7	130	-	-	-	-	561 330
EDF300PG	1	10.6	270	-	-	-	-	561 310
EDF400PG	1	14	360	-	-	-	-	561 340
EDF600PG	1	21.2	540	-	-	-	-	557 610
Clips fijador								
UFPSTCLPPG	3	-	-	-	-	-	-	589 110

* Cada kit de soporte incluye una barra transversal, 2 patas y 2 clips fijadores.

** PG → Acero Pregalvanizado.

UFT Kit de 90°

Charola plana – esta charola es utilizada en puntos T y uniones.

Clips para charola – Asegura la charola plana a la barra transversal en esquinas T y uniones.

UFFLAT

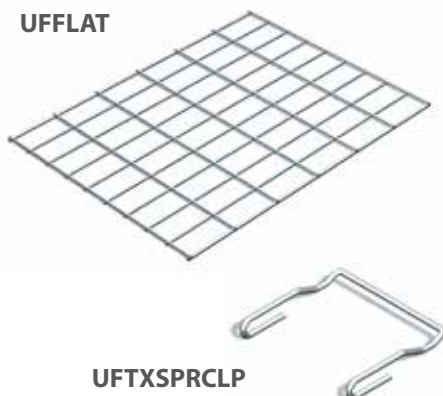

		H mm		W mm		L mm		PG
UFT Kit de 90°		pul	mm	pul	mm	pies	mm	
UFT90KIT**	1	-	-	18	450	2	600	942 923
Componentes del kit pueden ser ordenados individualmente								
Corner or Junction Tray/Clips								
UFFLATPG	1	-	-	18	450	20	600	942 917
UFTXSPRCLPPG	4	-	-	-	-	-	-	589 210

** Cada kit de 90° de soporte incluye 1 charola plana y 6 clips para charola.

CM 100/25

CM 100/25 50 → 100

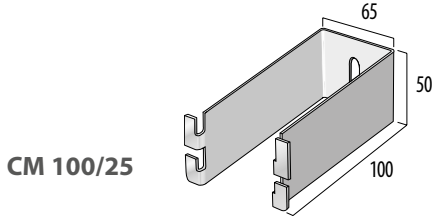

CM 100/25

(mm)

		L mm	EZ	GC	304L	316L
CM 100/25	10	100	-	-	595 900	-

CM 100/50

CM 100/50 100 → 600 100 → 600 (x2)

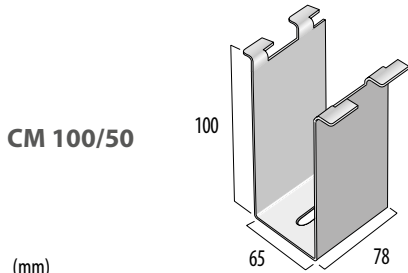
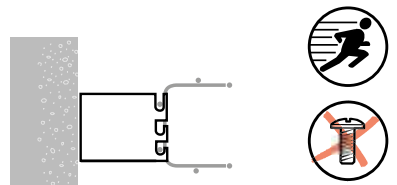

CM 100/50

(mm)

		L mm	EZ	GC	304L	316L
CM 100/50	10	100	-	-	595 910	-

CM 100/100

CM 100/100 50 → 100 100 → 600 (x2)

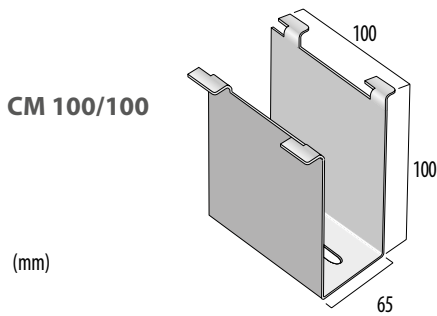
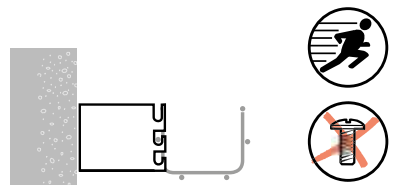

CM 100/100

(mm)

		L mm	EZ	GC	304L	316L
CM 100/100	10	100	-	-	595 920	-

UC 100/50

UC 100/50 50

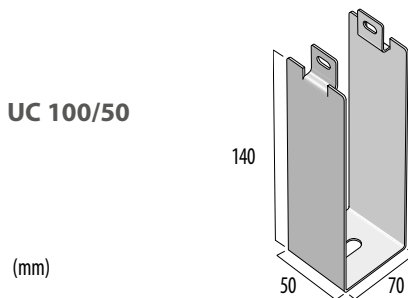
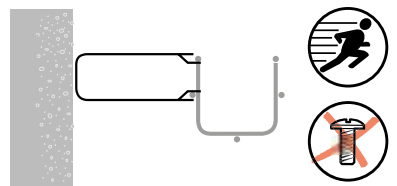

UC 100/50

(mm)

		L mm	EZ	GC	304L	316L
UC 100/50	10	140	-	-	595 930	-

Nota: Estos 4 códigos son para la industria de alimentos.

ETC



ETC CF30 - CF54 - CF105 - CF150 50 → 600 MM

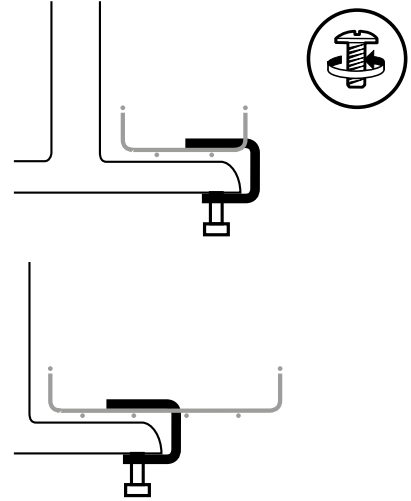

	H mm	kg/m	GC
ETC 20	20	0.1	942 819
ETC 30	30	0.2	942 820

PA 23

PA 23 CF30 - CF54 - CF105 - CF150 100 → 600 MM

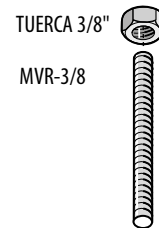

PA 23

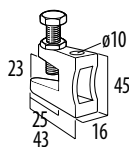

(mm)

	 daN	EZ	GC	304L	316L
PA23	1000	559 301	-	-	-

CLMFAS



CLMFAS CF30 - CF54 - CF105 50 → 600 MM

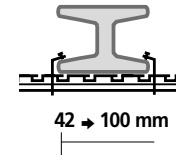

CLMFAS

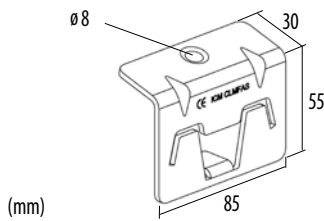

(mm)

	daN.m	GS	GC	304L	316L
CLMFAS	18	559 280	559 287	-	559 284

IBP 80 / IBP 105

IBP80 / IBP105 CF30 - CF150 50 → 600 MM

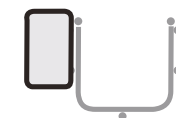
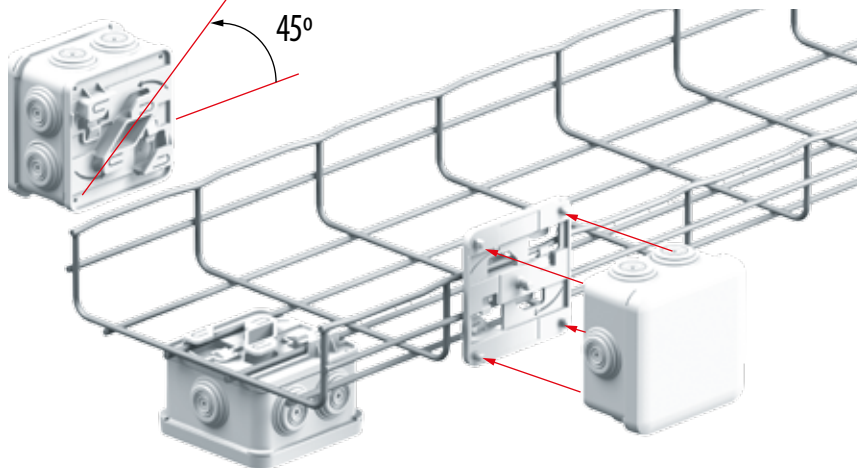

Libre de Halógeno

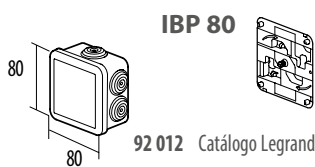

IBP 80

92 012 Catálogo Legrand

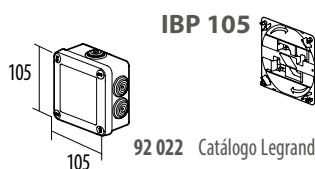

IBP 105

92 022 Catálogo Legrand

(mm)

		PLAST.	DC	304L	316L
IBP80	5	091 937	-	-	-

		PLAST.	DC	304L	316L
IBP105	5	091 938	-	-	-

BLF



BLF CF30 - CF54 - CF105 - CF150 50 → 600 MM

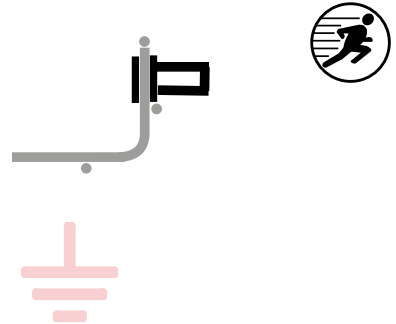
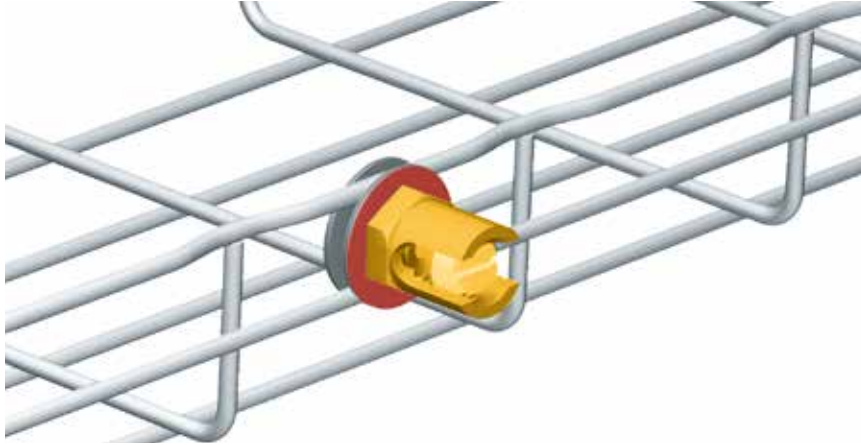

BLF

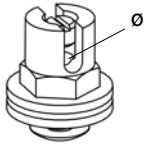

	L1 mm	Ø AWG	CU	GC	304L	316L
BLF 8/50	26	4 - 2/0	585 407	-	-	-

GNDSB

GNDSB CF30 - CF54 - CF105 - CF150 50 → 600 MM

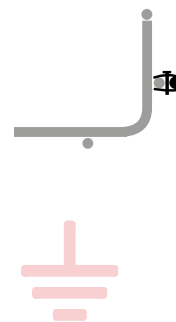
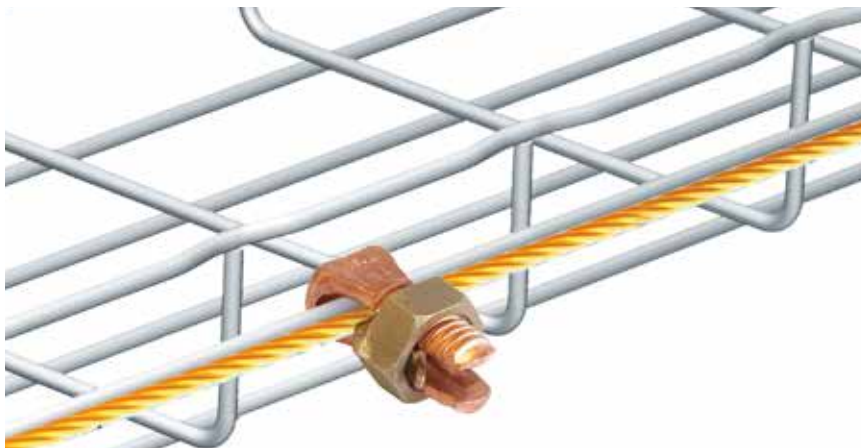

GNDSB

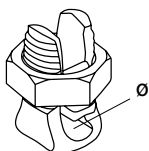

	L1 mm	Ø AWG	CU	GC	304L	316L
GNDSB	-	14 - 3	942 616	-	-	-

SBDN



SBDN CF30 - CF54 - CF105 - CF150 50 → 600 MM

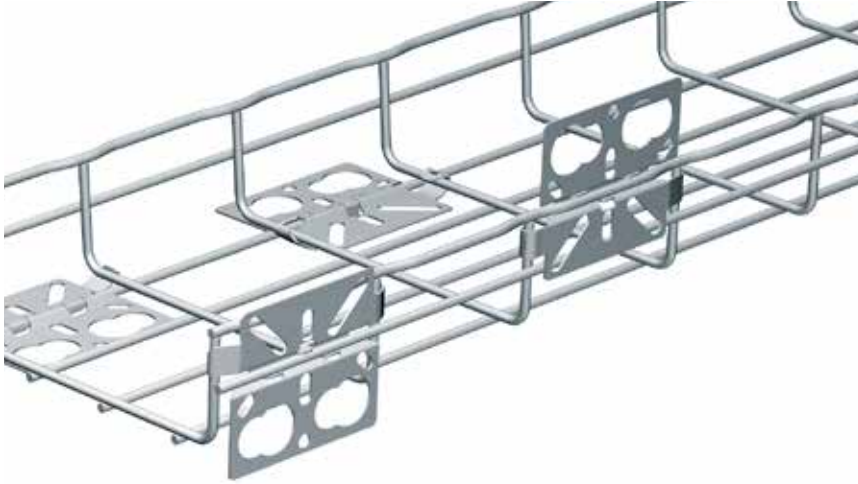

SBDN

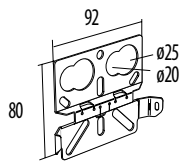

(mm)

	GS	DC	304L	316L
SBDN	585 410	585 417	-	-

CM50XL

CM50XL CF30 - CF54 - CF105 50 → 600 MM

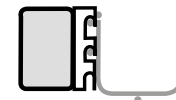

CM 50XL

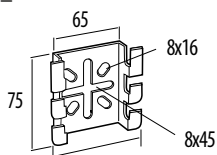

(mm)

	daN	GS	GC	304L	316L
CM 50XL	100	586 130	586 133	586 138	586 134

SBD - EXSBD



SBD-EXSBD CF30 - CF54 - CF105 - CF150 50 → 600 MM

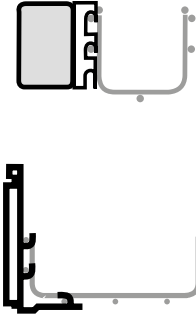
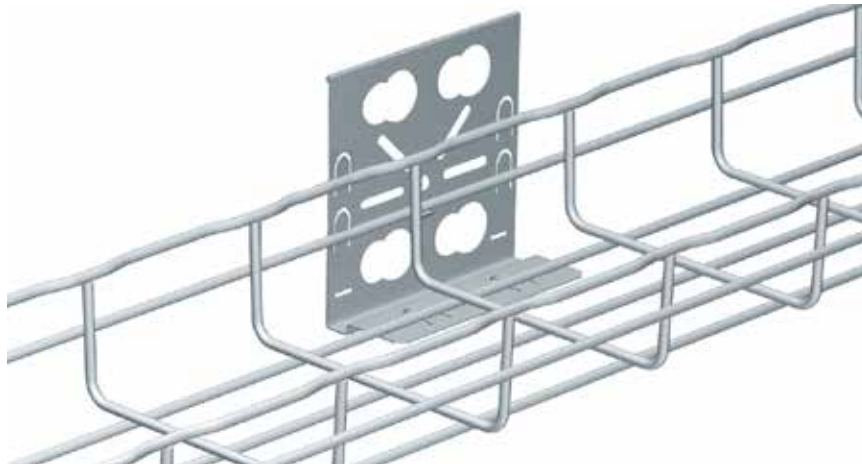

SBD
EXSBD

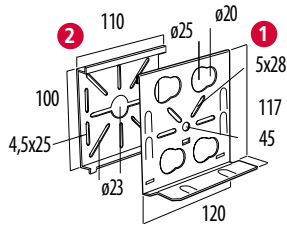

	GS	GC	304L	316L
SBD	585 110	-	-	585 114
EXSBD	585 130	-	-	-

MFPOLYA

MFPOLYA CF30 - CF54 - CF105 - CF150 50 → 600 MM

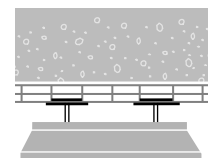

MFPOLYA

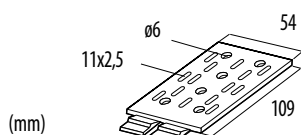

	L1 mm	Polyamid	GC	304L	316L
MFPOLYA	10	585 145	-	-	-

FAS ROLLER



FAS ROLLER CF30 - CF54 - CF105 - CF150 50 → 600 MM

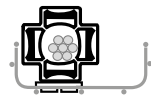
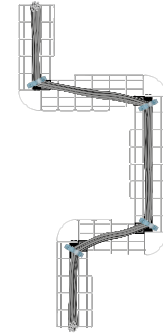
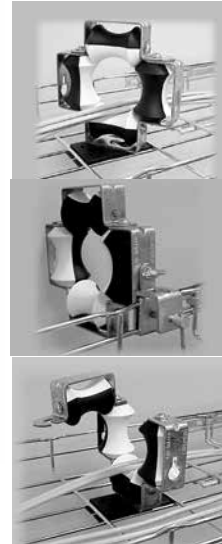
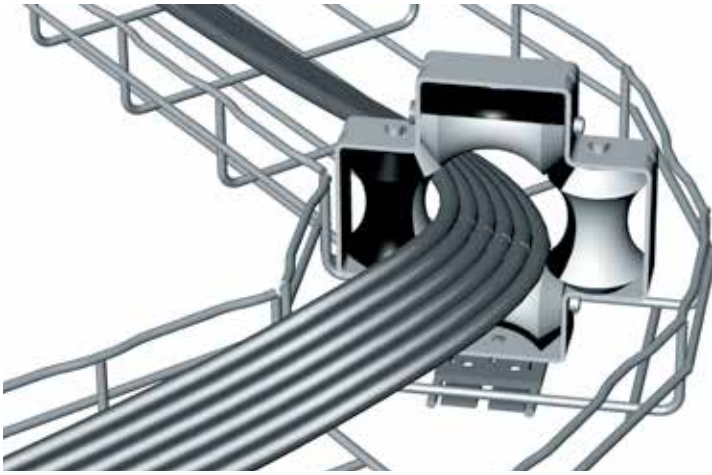

FAS ROLLER

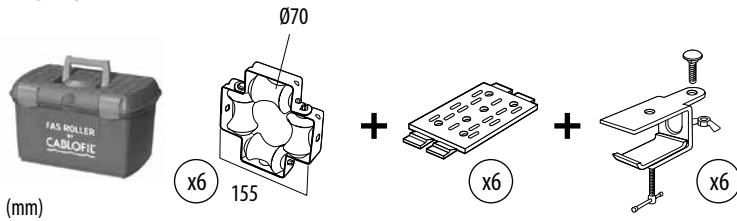

GS	GC	304L	316L
011 100	-	-	-

DEV 100 - CABLOGRIP

DEV 100 - CABLOGRIP CF30 - CF54 - CF105 - CF150 50 → 600 MM

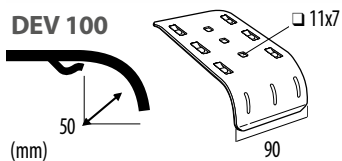
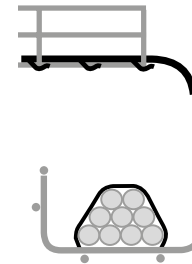
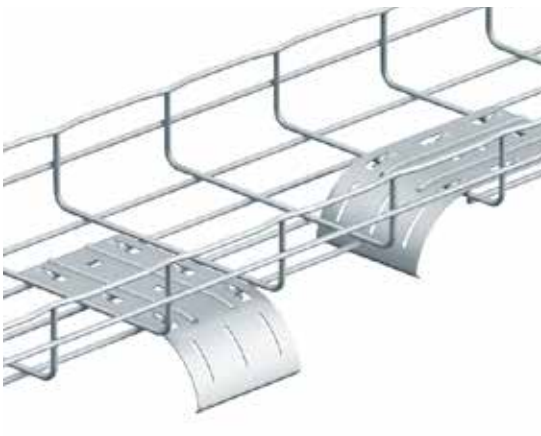

	L1 mm	GS	DC	304L	316L
DEV 100	-	585 160	585 167	-	585 164

CABLOGRIP

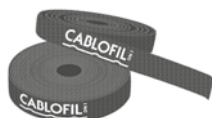

	L1 mm	PLAST	DC	304L	316L
CABLOGRIP	5000	559 677	-	-	-

EZ-PATH PARED



EZ-PATH PARED CF30 → CF150 50 → 600 MM

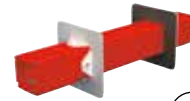
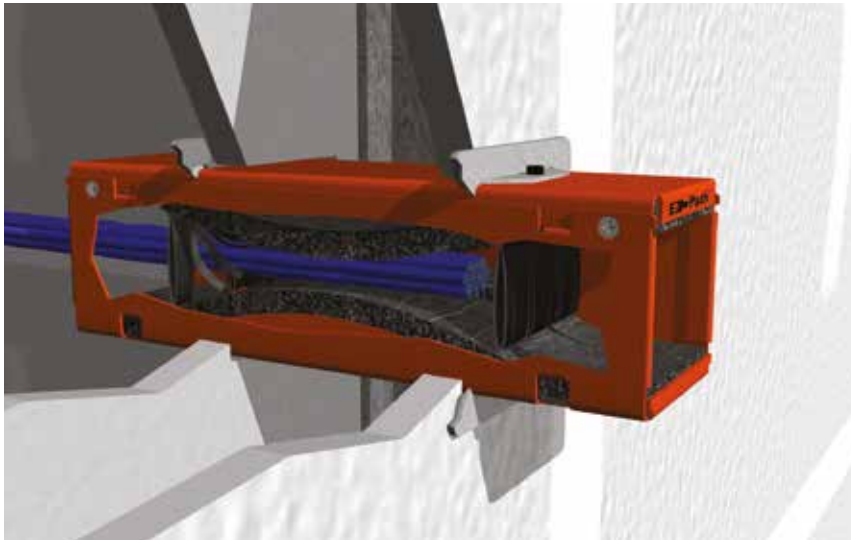

EZDP 22

x1



EZP 133CW

x2



EZD 33

x1

EZD 144W

x2



EZD 44

x1

EZD33
EZD44 L

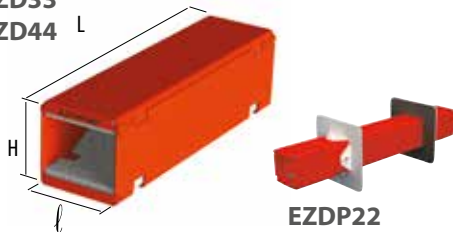

EZDP22

	H mm	l mm	L mm				
EZDP 22	37	37	267	23	31	→	250 518
EZD 33	75	75	267	56	69	6	250 018
EZD 44	114	102	310	78	97	4	250 058

EZP

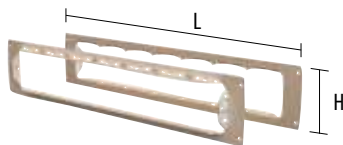

EZP 133W→733W

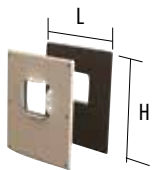

EZP 133R



EZP 133CW



EZP 133SP

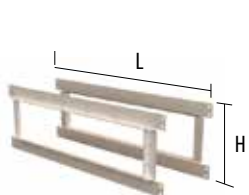

(mm) EZP 544W

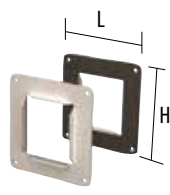

EZP 144W



EZP 144SP

	→	L mm		
EZP 133W	1 x EZD 33	102	2	250 110
EZP 233W	2 x EZD 33	185	2	250 120
EZP 333W	3 x EZD 33	291	2	250 130
EZP 433W	4 x EZD 33	406	2	250 140
EZP 733W	7 x EZD 33	610	2	250 170

EZP 133R	1 x EZD 33	-	2	250 210
EZP 133CW	1 x EZD 33	-	2	250 240
EZP 133SP	1 x EZD 33	-	2	250 180

EZP 144W	1 x EZD 44	178	2	250 230
EZP 544W	1→5 x EZD 44	610	2	250 250
EZP 144SP	1 x EZD 44	-	2	250 300

EZD 33E - RCM 33

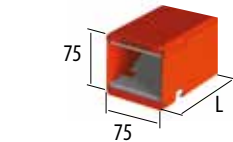

(mm)

EZD 33E



RCM 33

EZD 33E	1 x EZD 33	151	1	250 078
RCM 33	1 x EZD 33	-	2	250 206

EZ-PATH PISO



EZ-PATH PISO CF30 → CF150 50 → 600 MM

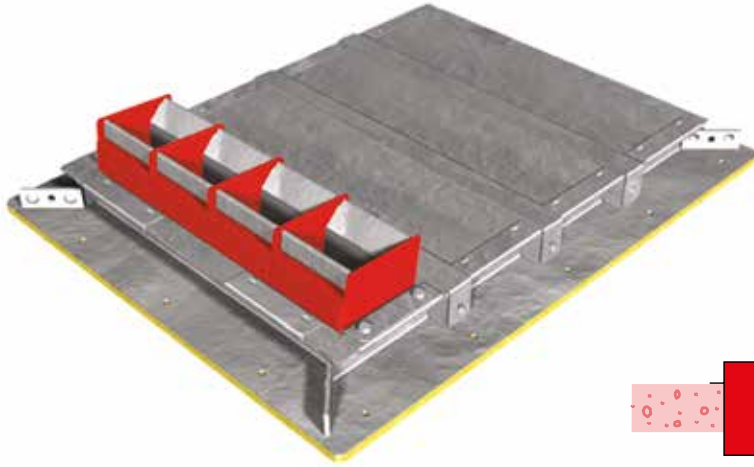

EZP 133K (x1)



EZD 33 (x1)



EZP 144F (x1)

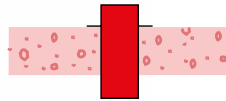

EZD 44 (x1)

		Ø mm		
EZP 133K	1 x EZD 33	139	1	250 220
EZG 144T	1 x EZD 44	-	1	250 260
EZDG 444	-	-	1	250 098
EZD 444MB	-	-	1	250 088
EZG 844	2 x EZD 444MB	-	1	250 280
EZG 1644	4 x EZD 444MB	-	1	250 290



Índice

62-76
Instalación de
las bandejas



Cómo cortar una bandeja portacables

62



Curvas de gran radio de curvatura

63



Curvas de gran radio de curvatura

66



Curvas de pequeño radio

68



Curvas de ángulo recto

70



T O cruz de ángulos rectos

72



T O cruz de ángulos cortados

74



Reducción de sección, cambio de nivel

76

CÓMO CORTAR UNA BANDEJA PORTACABLES



	L mm	KG	Kg/1
COUPFILGM	630	2,7	559 507

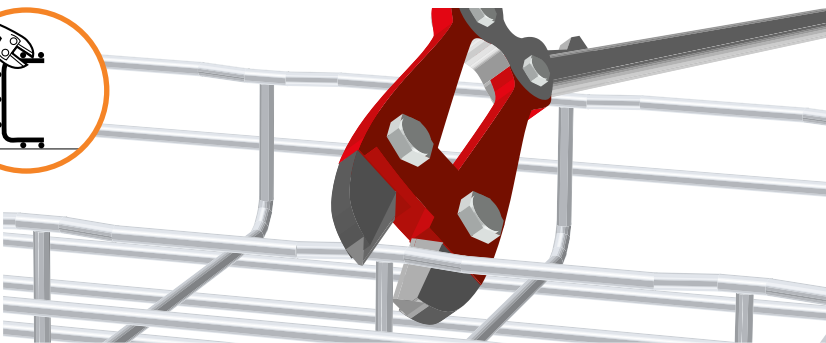
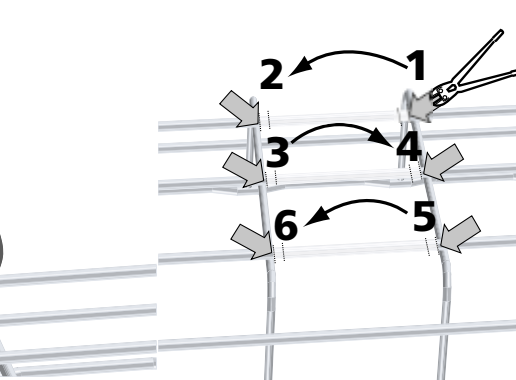
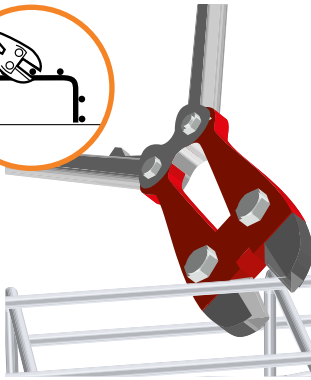
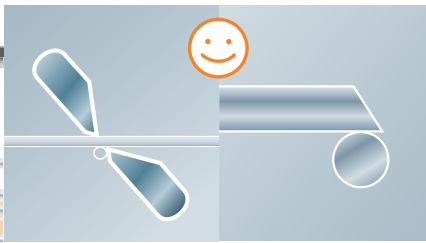
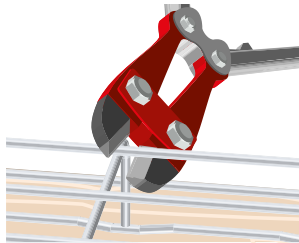
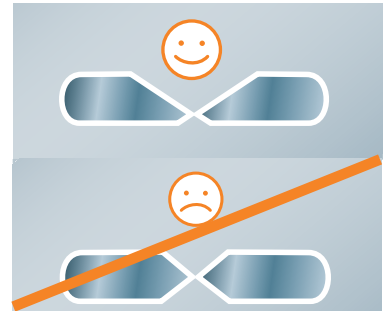

cuty fil



	L mm	KG	Kg/1
CUTY-FIL	-	3,7	559 548



Cargador	559 558
Bateria	559 567
Accesorio de corte	559 577

CURVAS DE GRAN RADIO DE CURVATURA



FASLOCK  100 → 600 MM

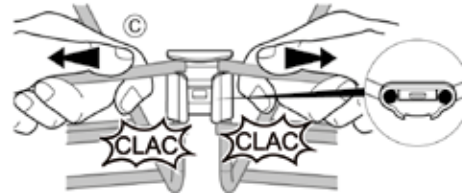
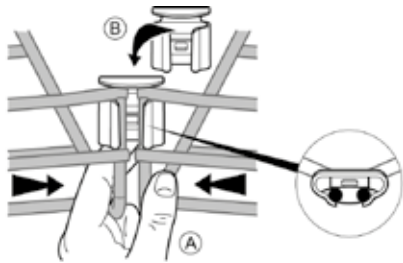

CE25 / CE30  50 → 600 MM

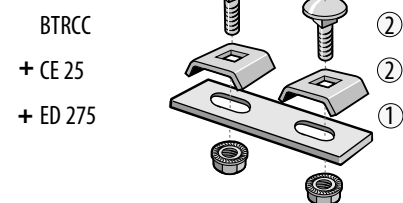
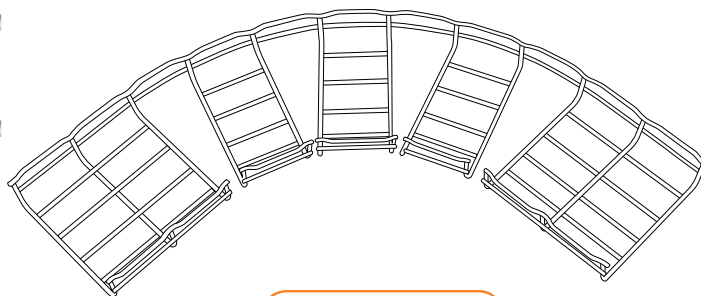
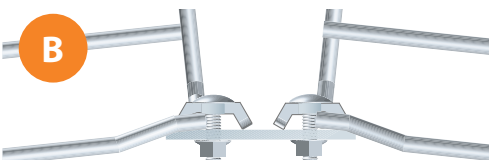
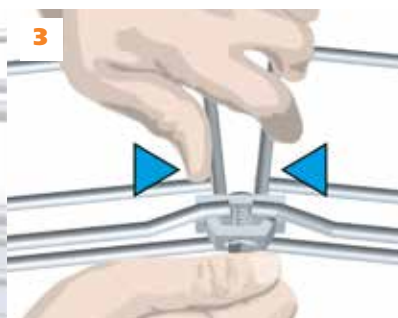
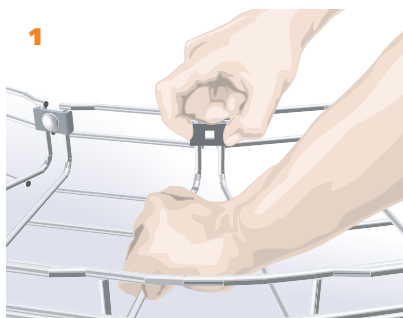
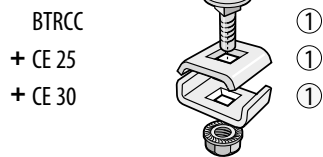
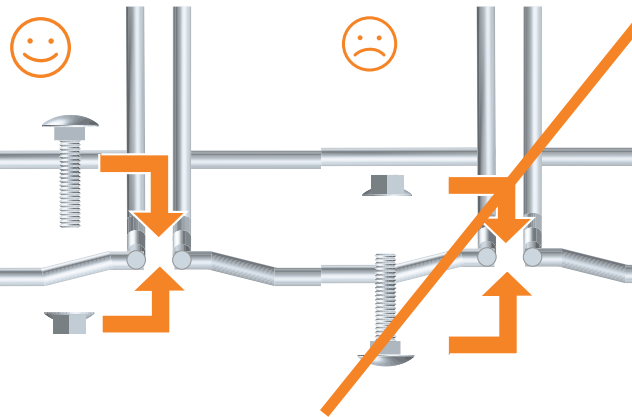
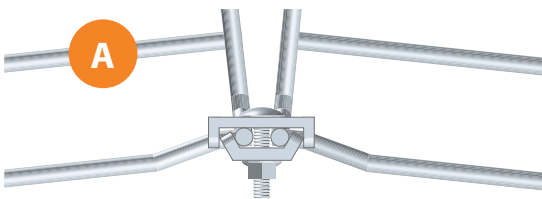

CURVAS DE GRAN RADIO DE CURVATURA



50 MM

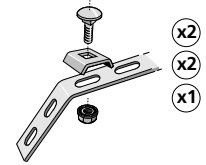
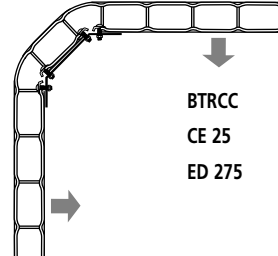
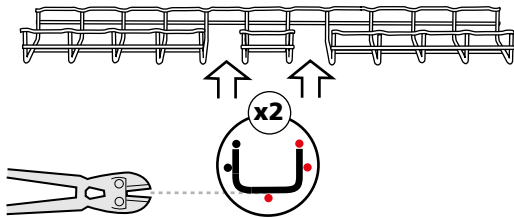

100 MM

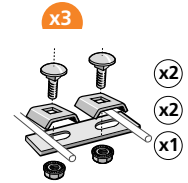
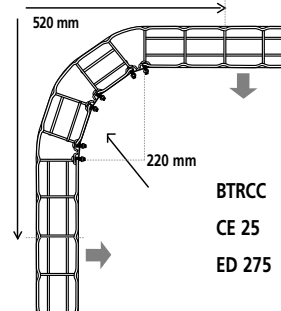
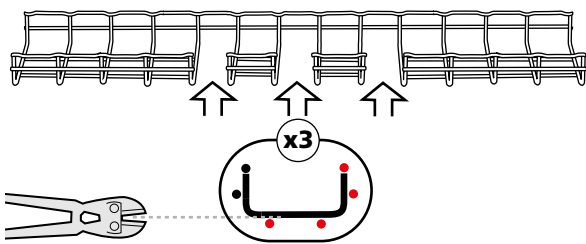

150 MM

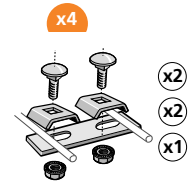
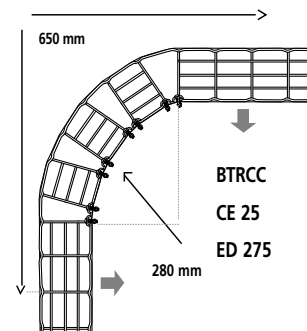
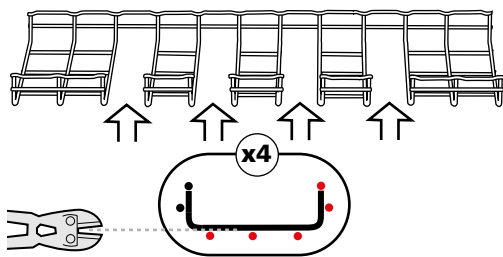

200 MM

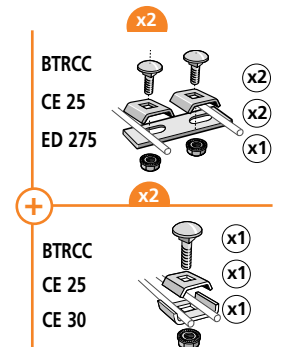
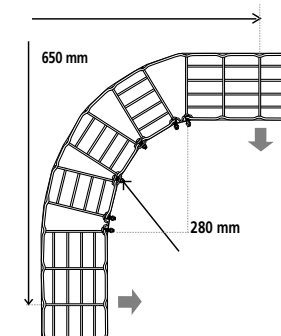
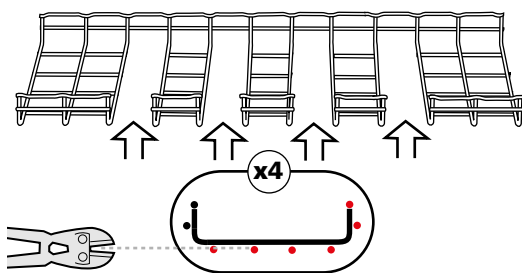

300 MM

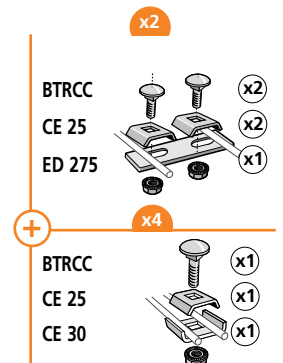
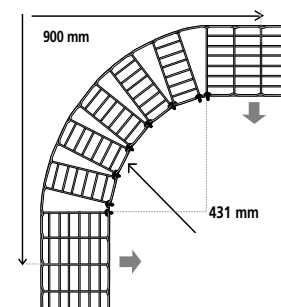
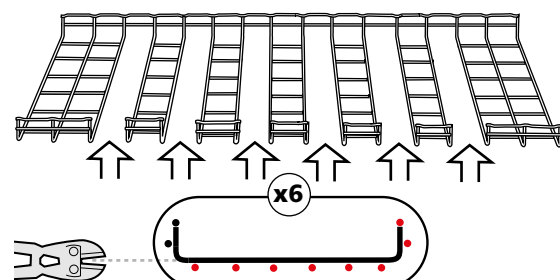



400 - 450 MM

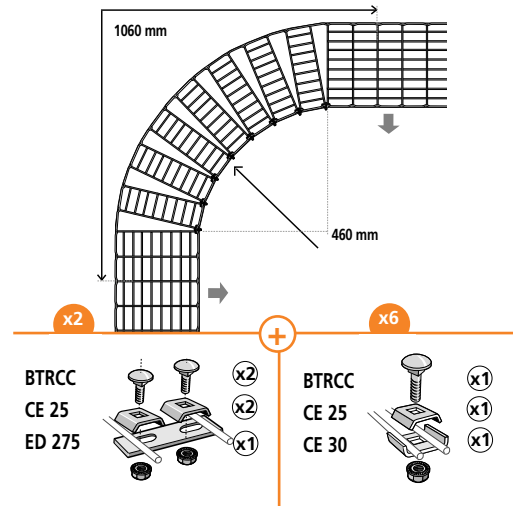
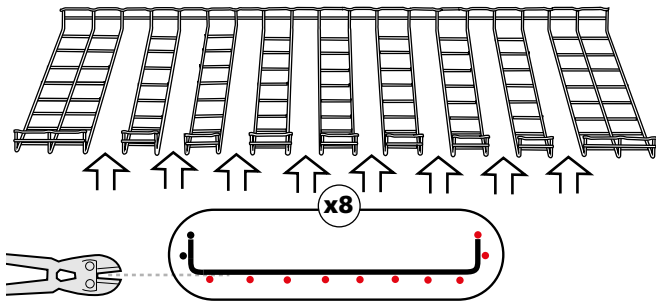

500 MM

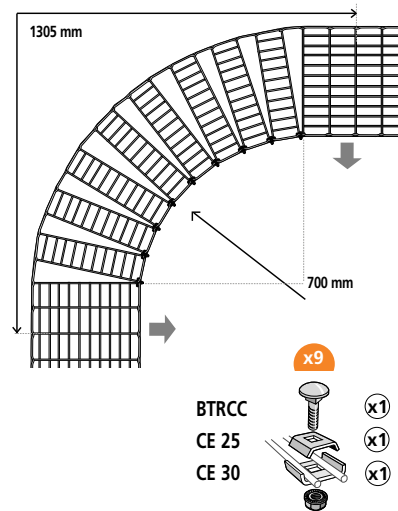
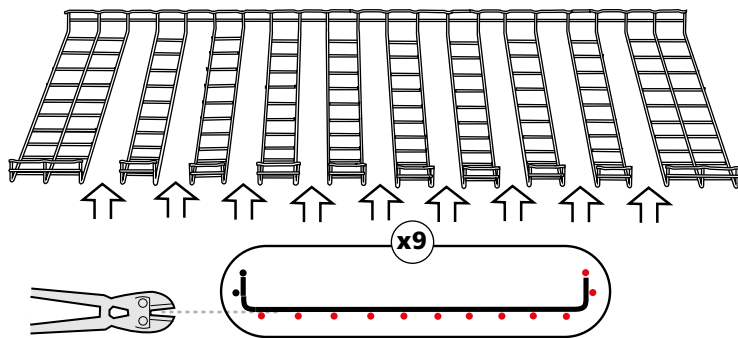

600 MM

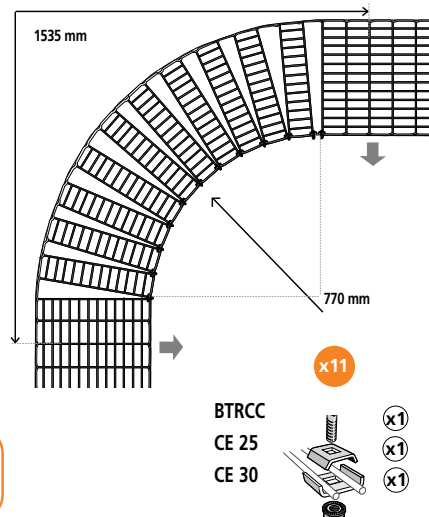
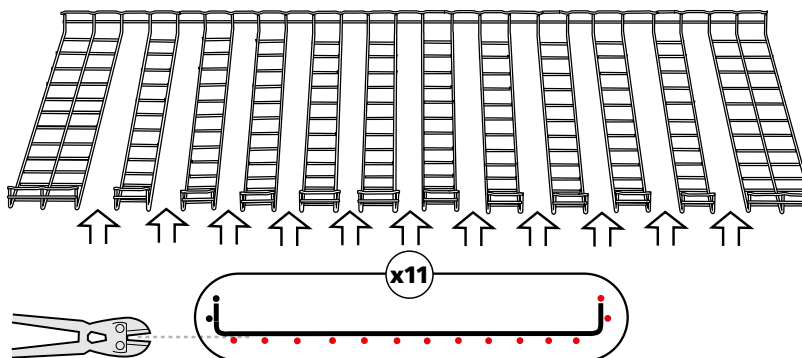

CURVAS DE GRAN RADIO DE CURVATURA



FASLOCK

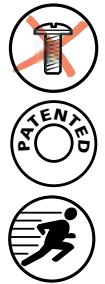
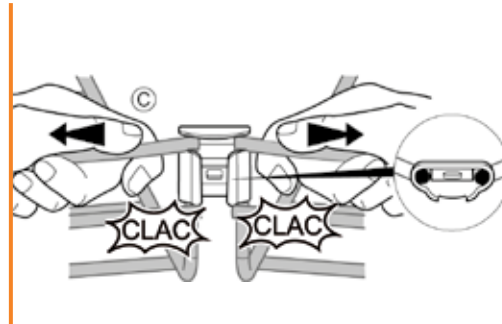
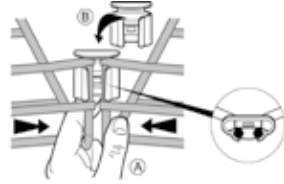

FASLOCK S = $\leftarrow \rightarrow$ 100 \rightarrow 200 mm

FASLOCK XL = $\leftarrow \rightarrow$ 300 \rightarrow 600 mm

$\leftarrow \rightarrow$ 100 MM

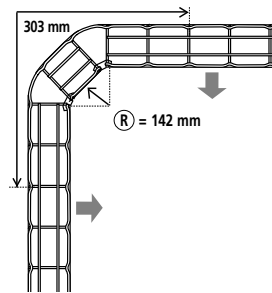
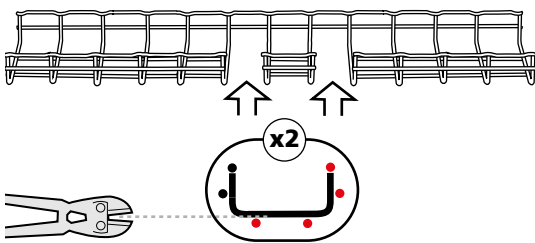

$\leftarrow \rightarrow$ 150 MM

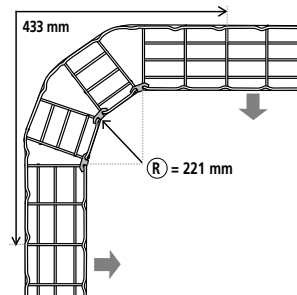
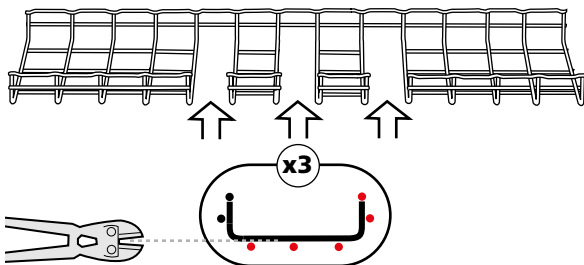

$\leftarrow \rightarrow$ 200 MM

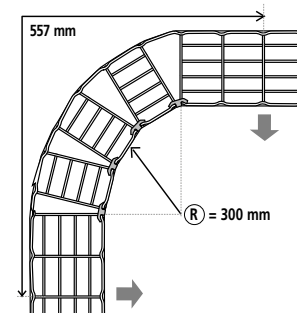
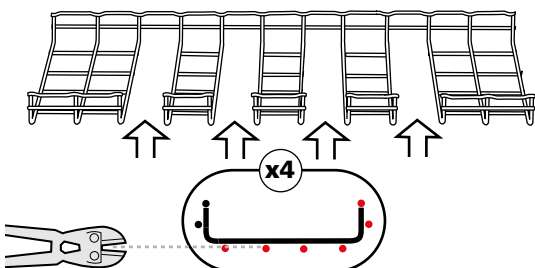

$\leftarrow \rightarrow$ 300 MM

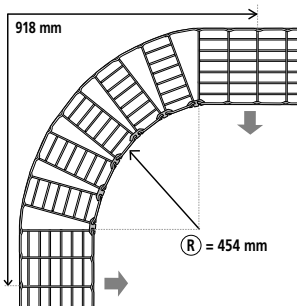
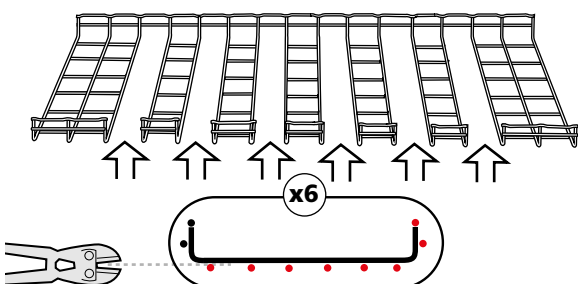



400 MM

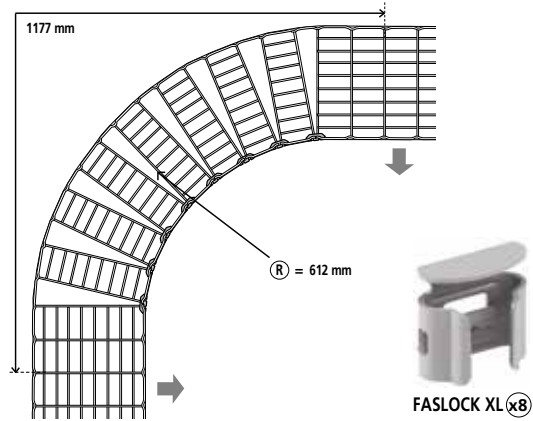
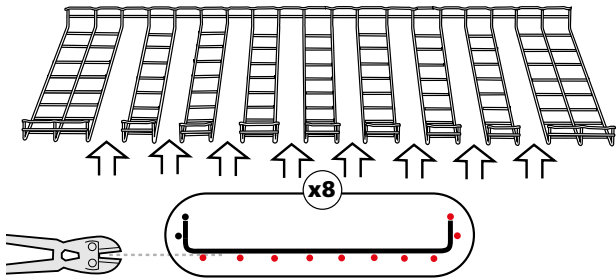

450 MM

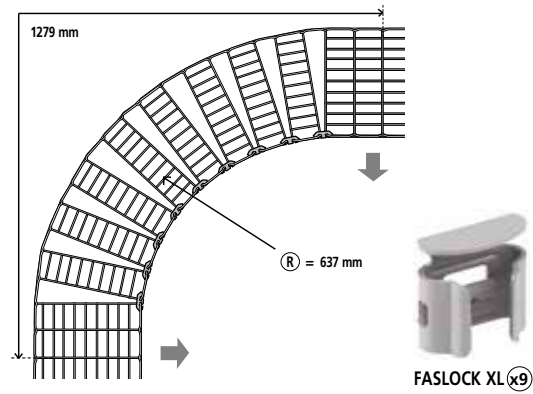
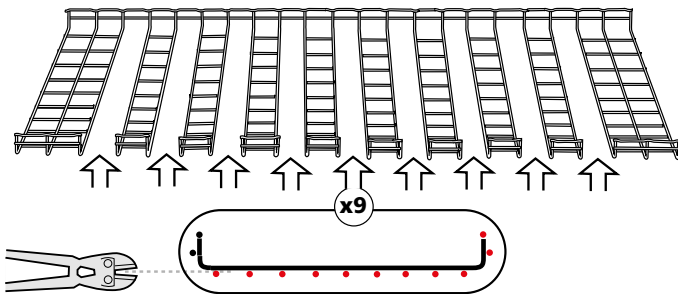

500 MM

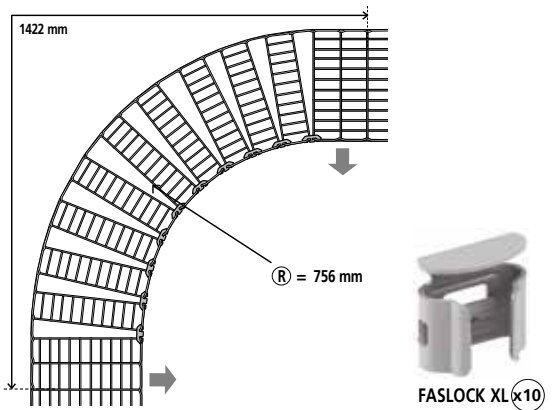
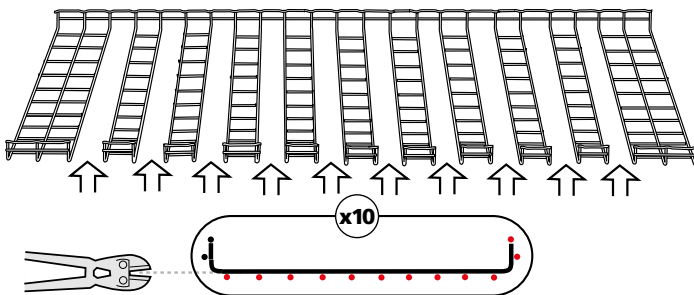

600 MM

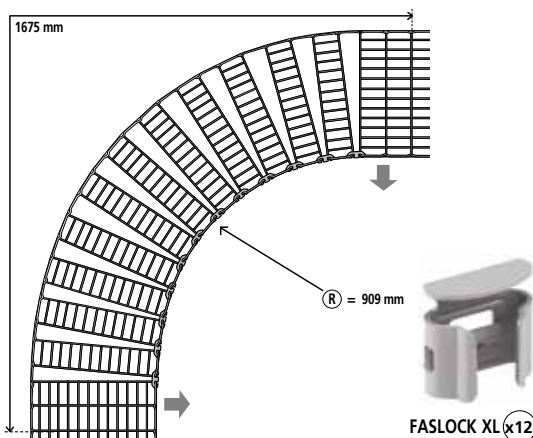
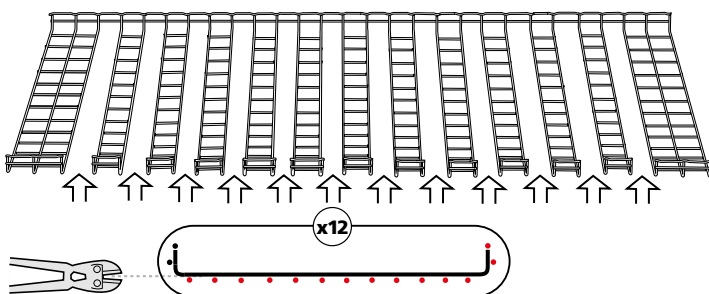

CURVAS DE PEQUEÑO RADIO



50 MM

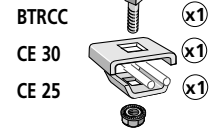
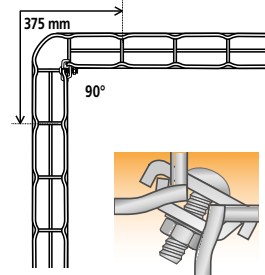
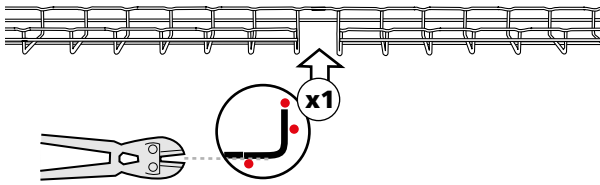

100 MM

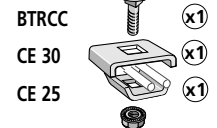
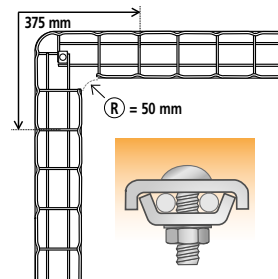
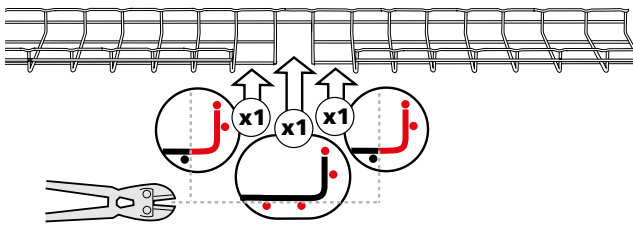

150 MM

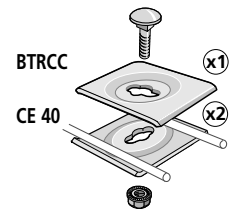
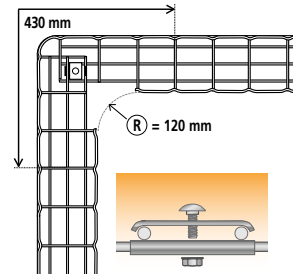
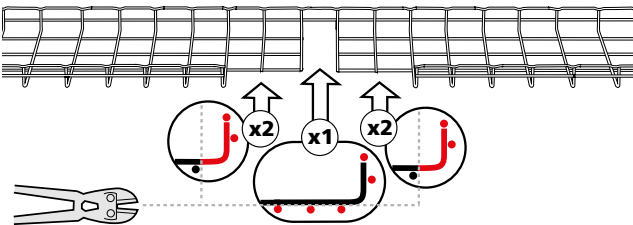

200 MM

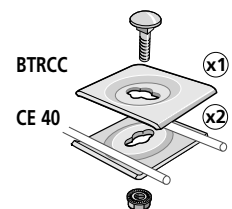
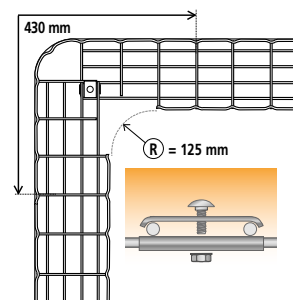
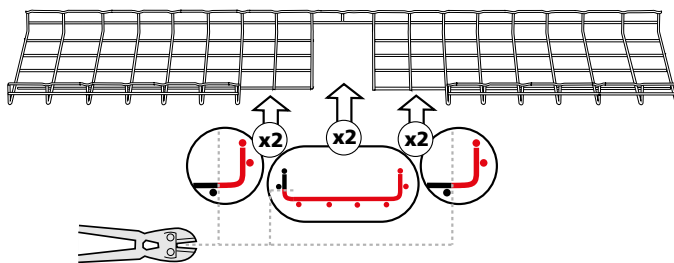

300 MM

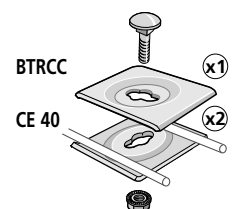
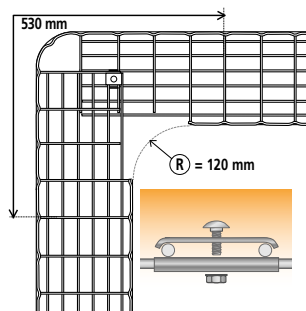
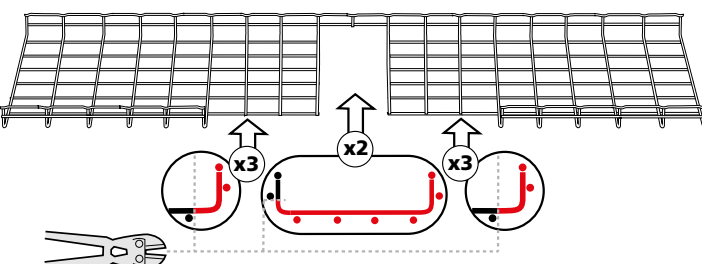



400 - 450 MM

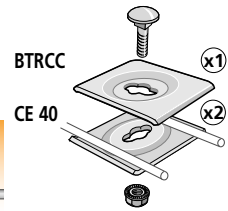
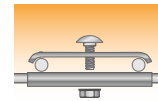
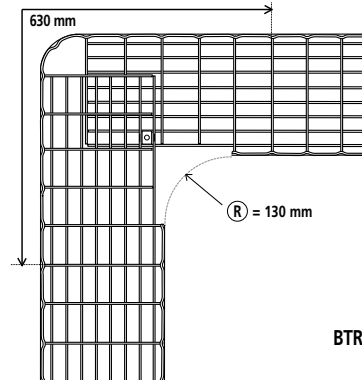
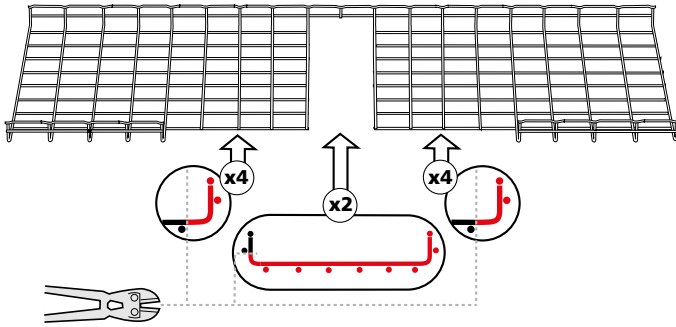

500 MM

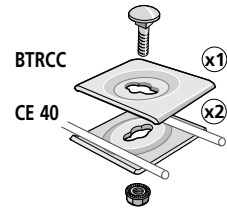
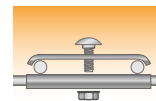
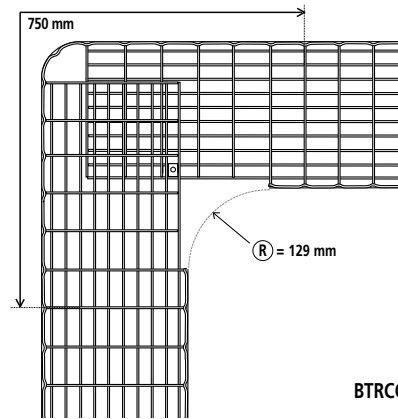
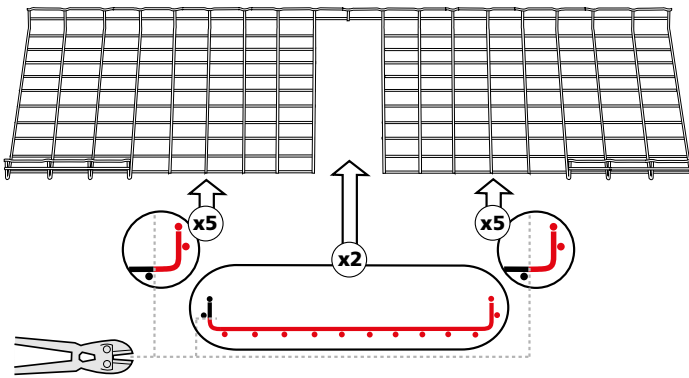

600 MM

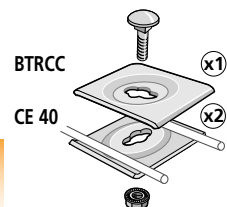
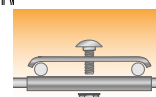
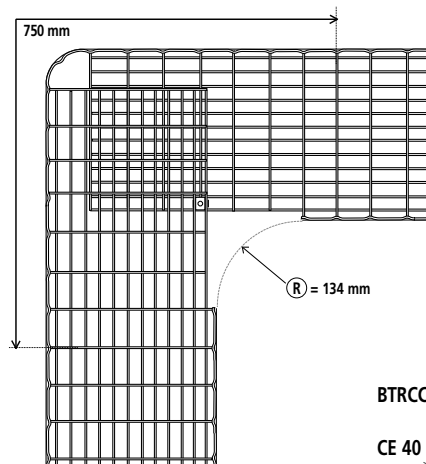
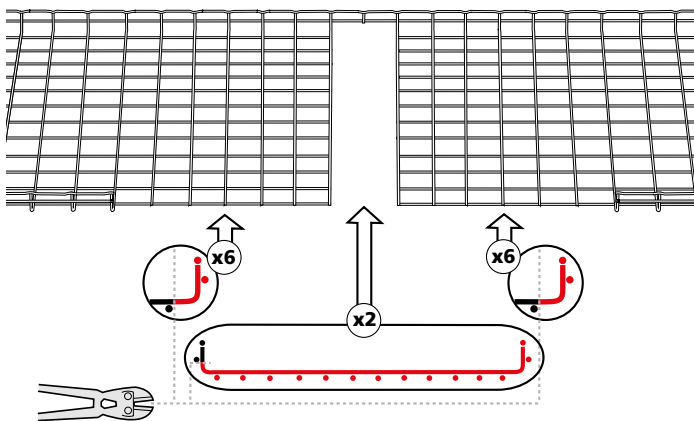

CURVAS DE ÁNGULO RECTO



100 MM

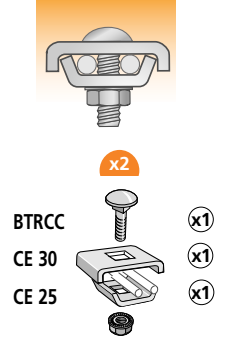
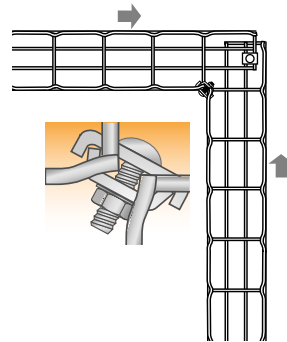
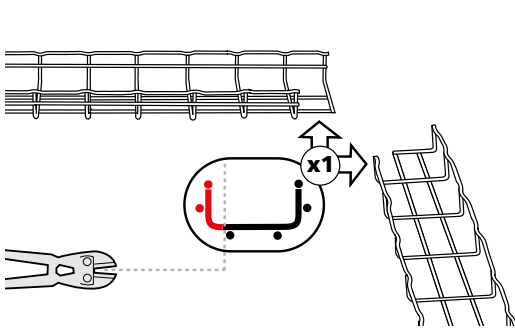

150 MM

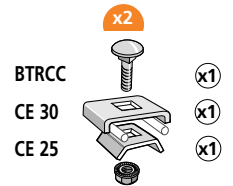
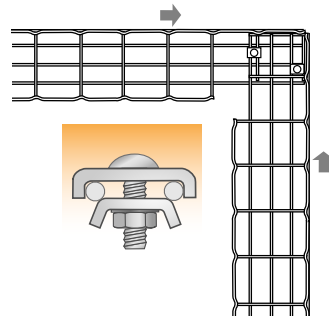
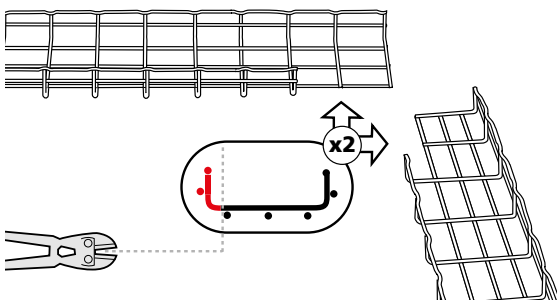

200 MM

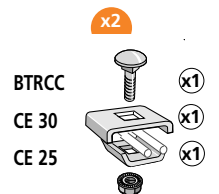
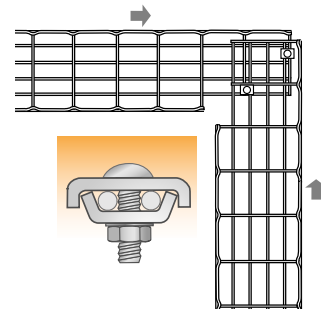
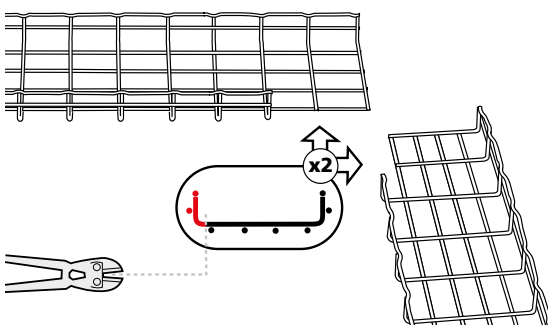

300 MM

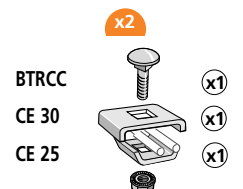
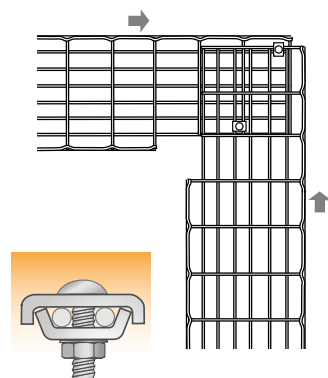
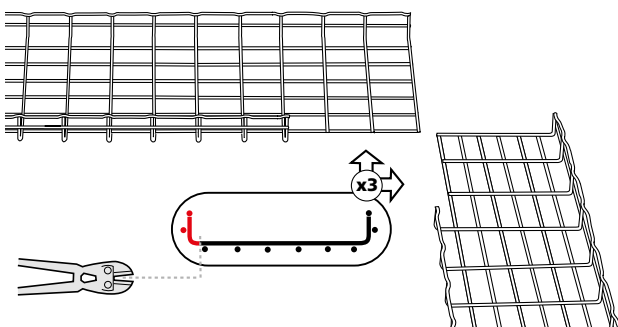

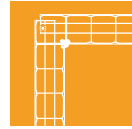

400 MM

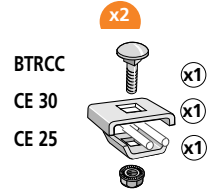
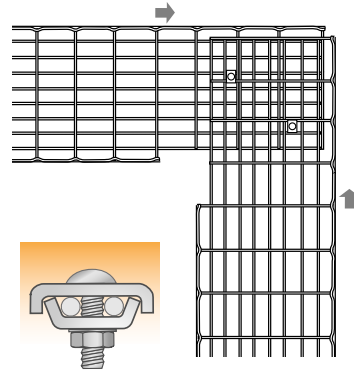
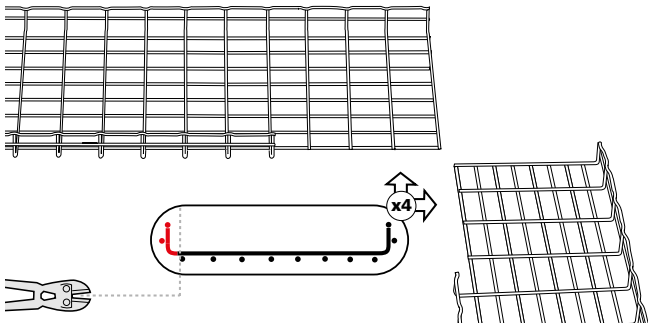

500 MM

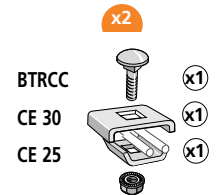
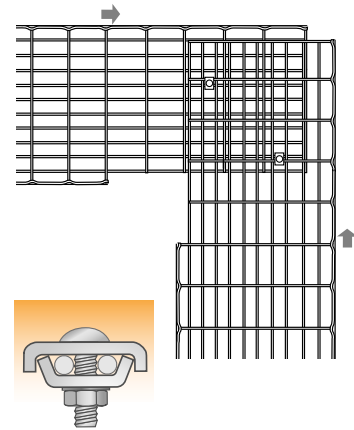
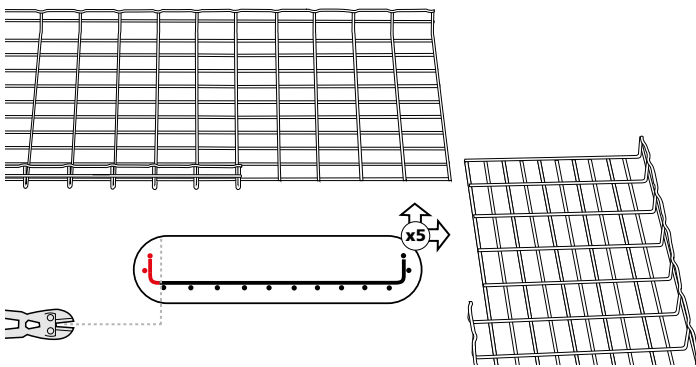

600 MM

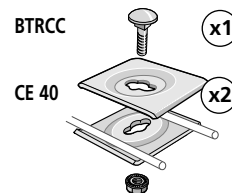
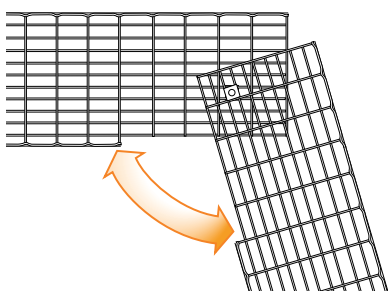
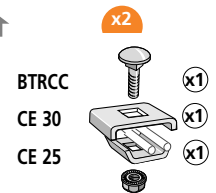
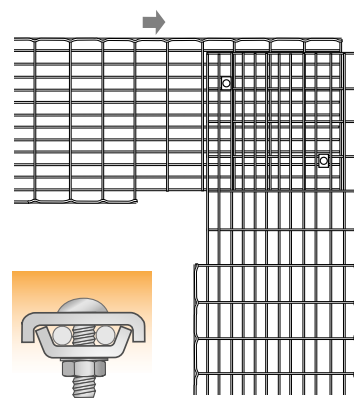
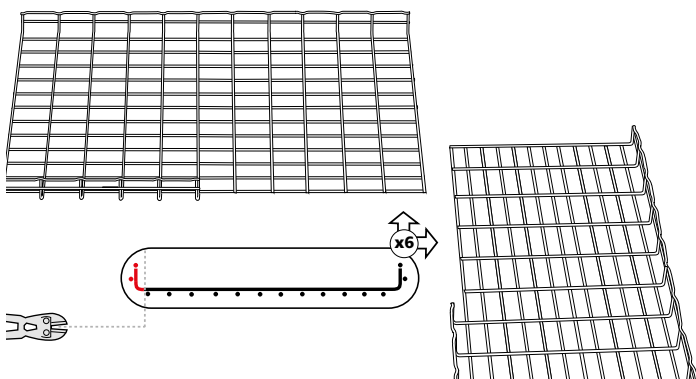

T O CRUZ DE ÁNGULOS RECTOS



50 MM

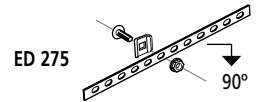
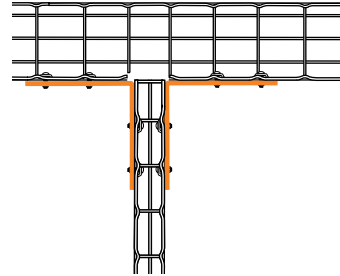
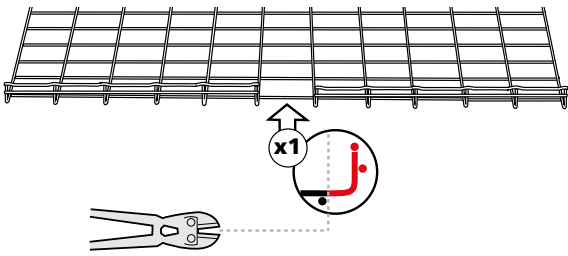

100 MM

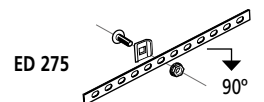
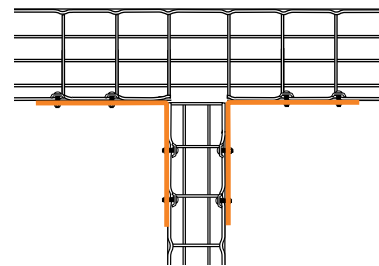
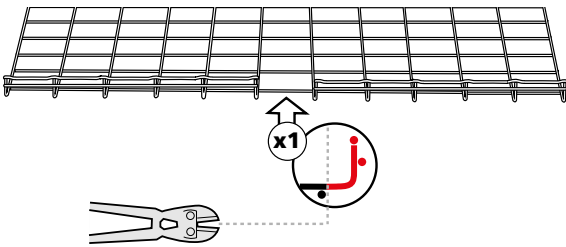

150 MM

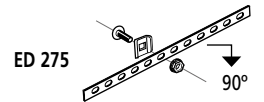
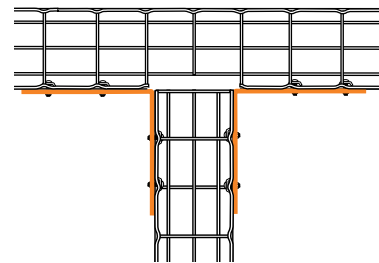
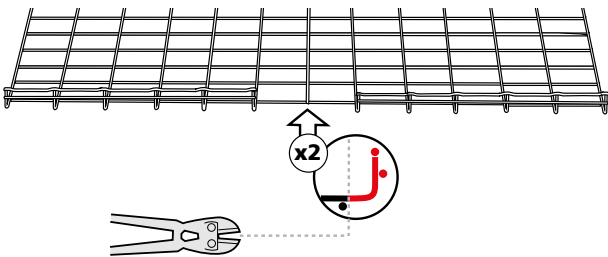

200 MM

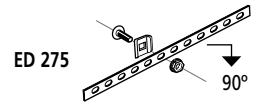
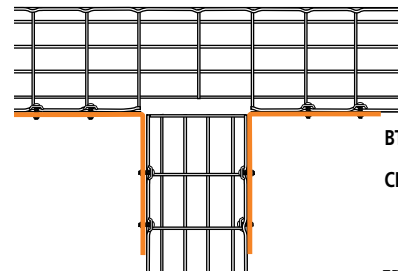
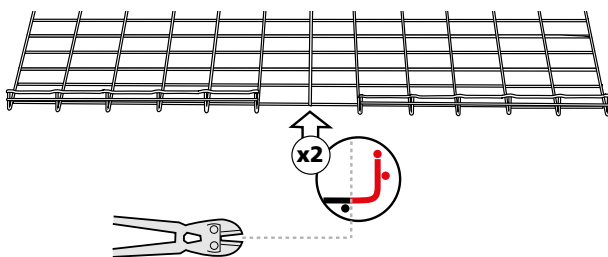

300 MM

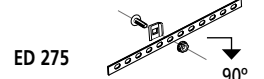
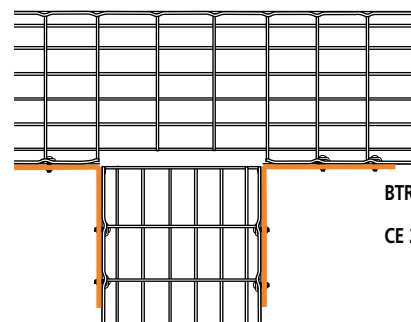
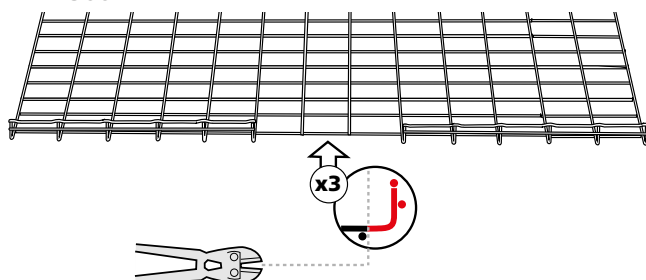



400 MM

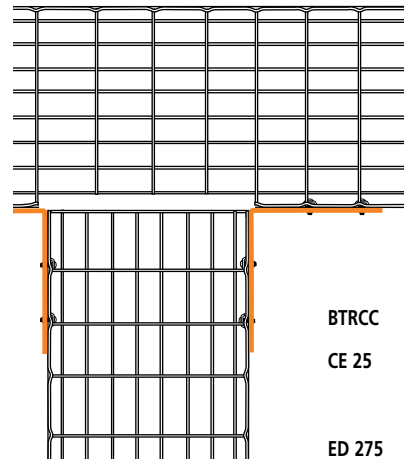
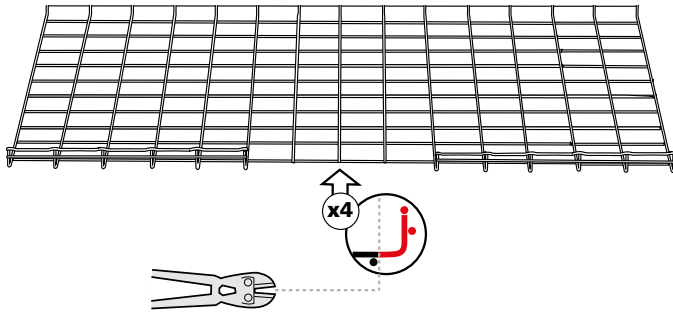

BTRCC
CE 25

ED 275

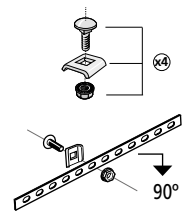

450 - 500 MM

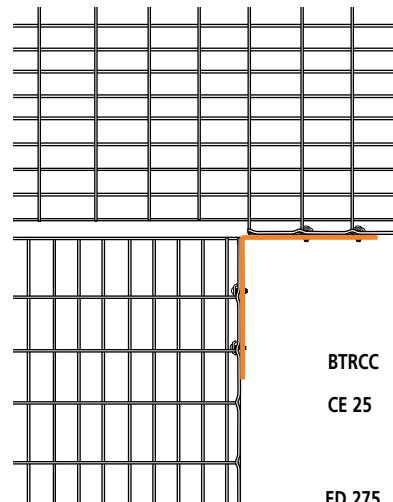
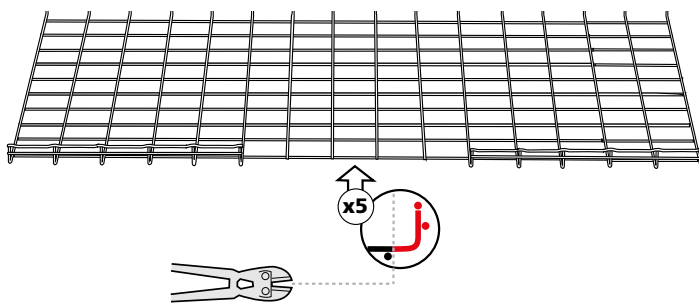

BTRCC
CE 25

ED 275

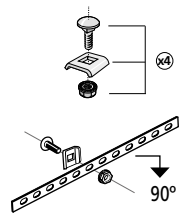

600 MM

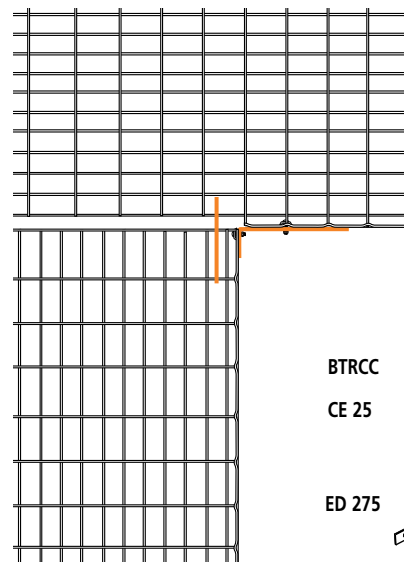
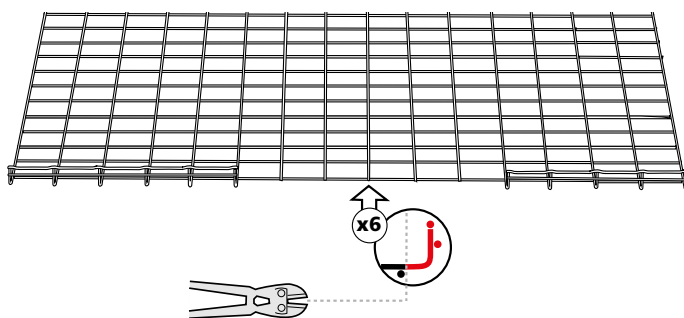

BTRCC
CE 25

ED 275

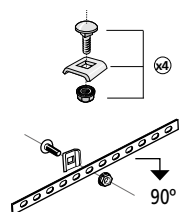

T O CRUZ DE ÁNGULOS CORTADOS



100 MM

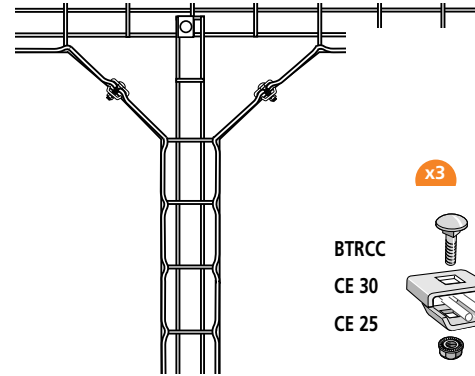
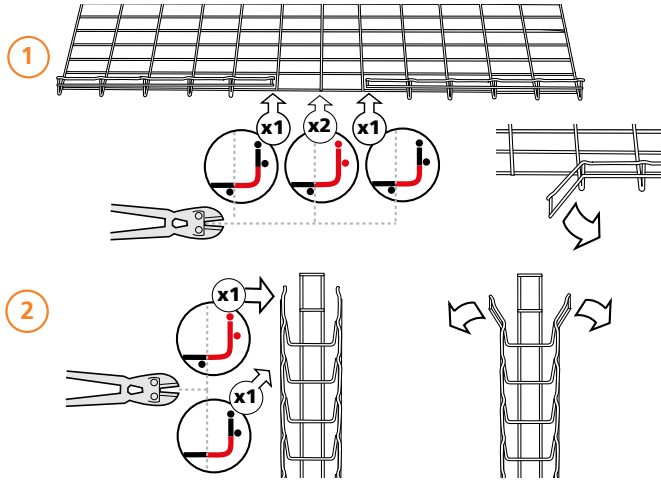

- x3**
- BTRCC x1
- CE 30 x1
- CE 25 x1

150 MM

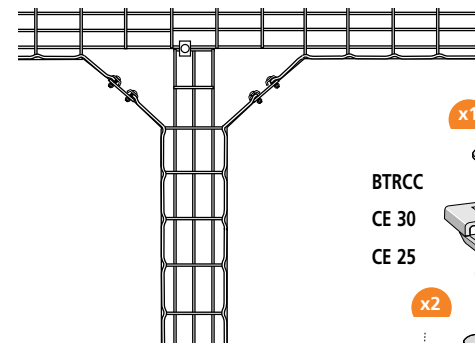
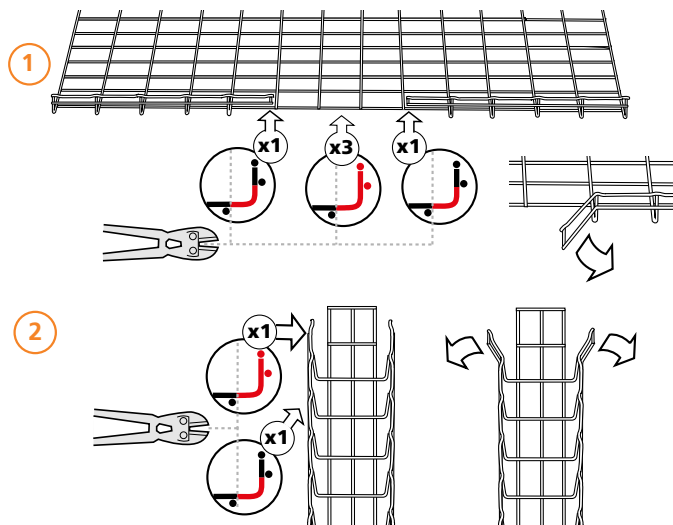

- x1**
- BTRCC x1
- CE 30 x1
- CE 25 x1
- x2**
- BTRCC x2
- CE 25 x2
- ED 275 x1

200 MM

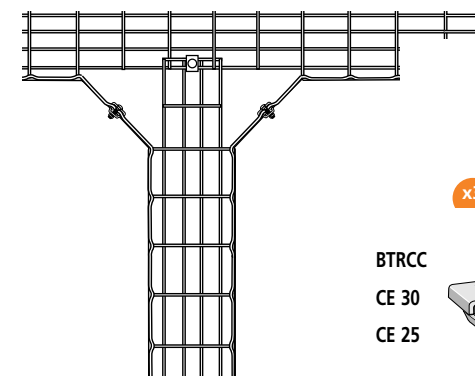
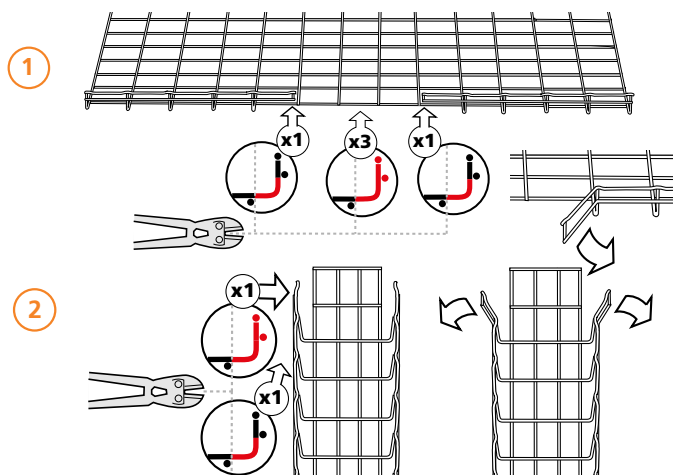

- x3**
- BTRCC x1
- CE 30 x1
- CE 25 x1



↔ 300 - 500 - 100 MM

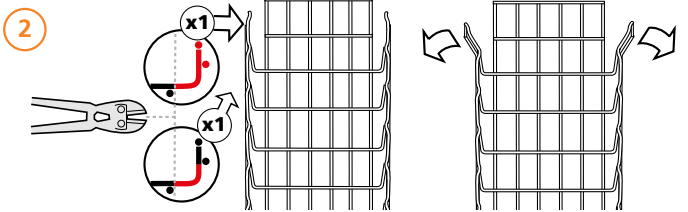
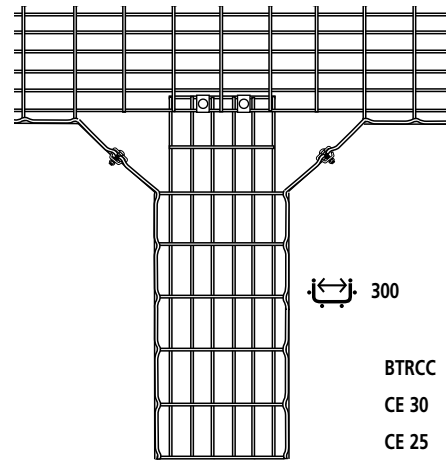
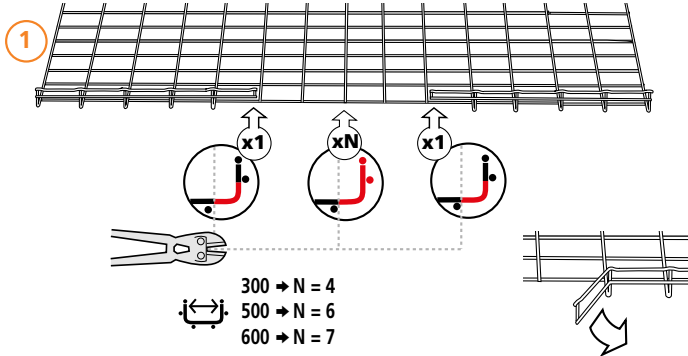

↔ 400 MM

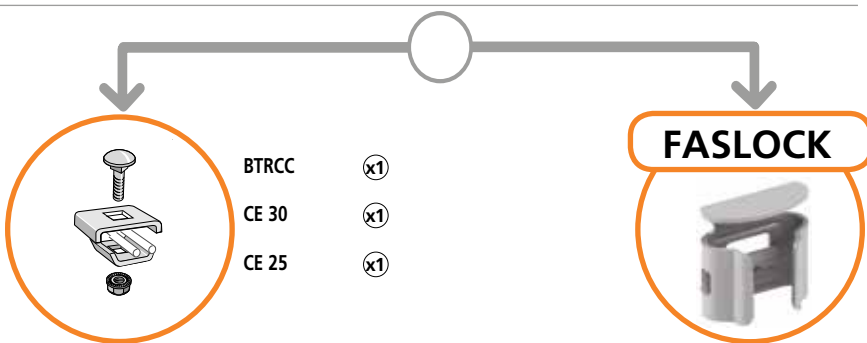
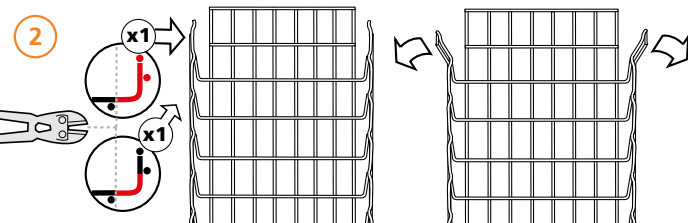
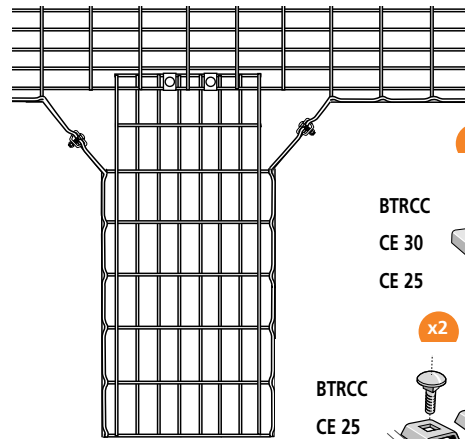
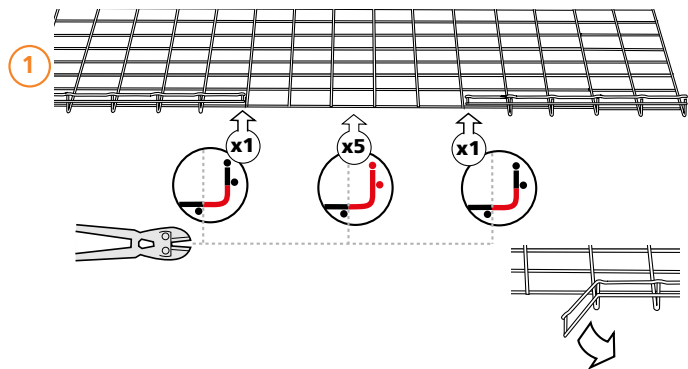

FASLOCK S = ↔ 100 → 200 mm
FASLOCK XL = ↔ 300 → 600 mm



REDUCCIÓN DE SECCIÓN, CAMBIO DE NIVEL



50 MM

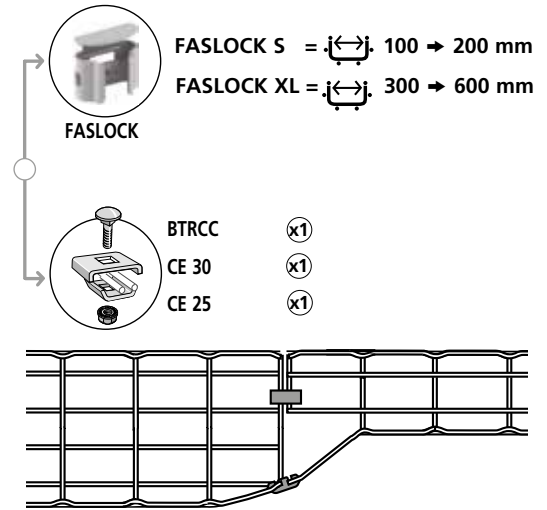
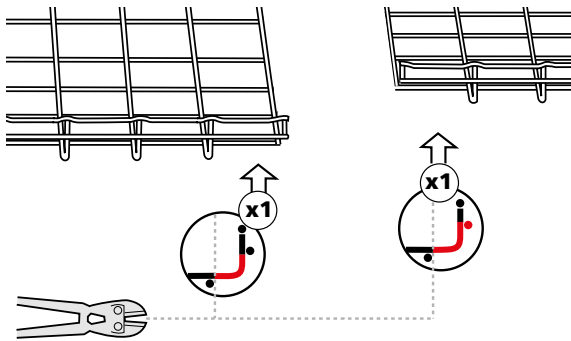

100 MM

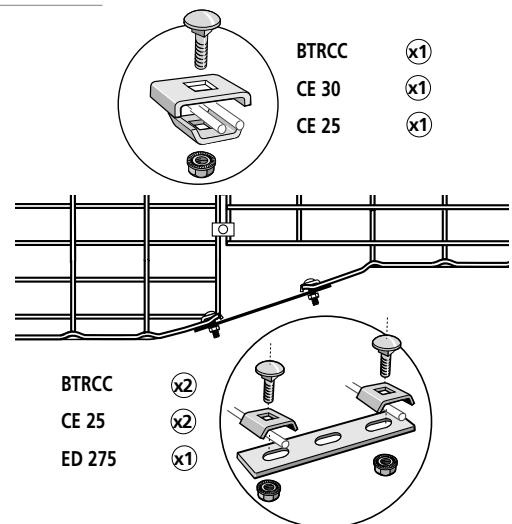
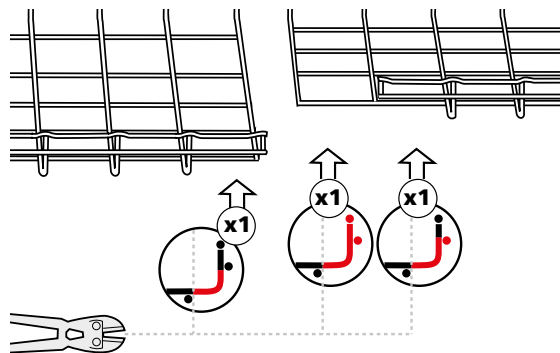

200 MM

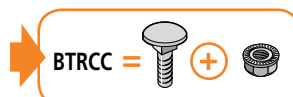
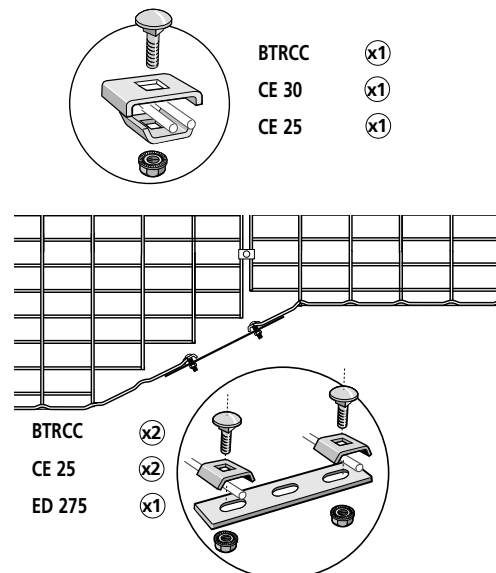
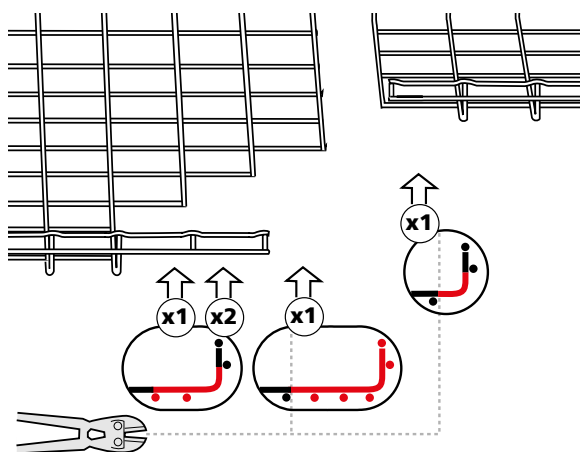

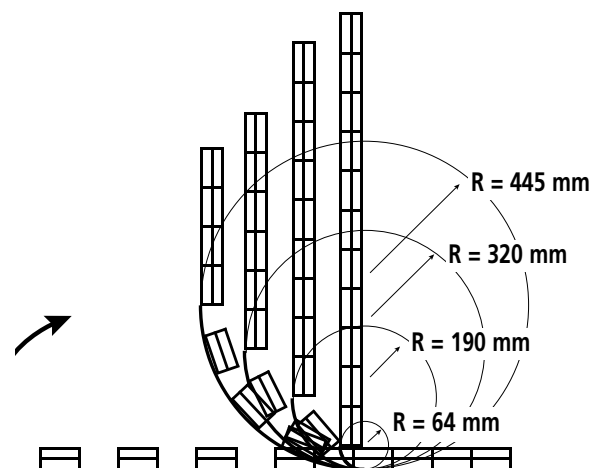
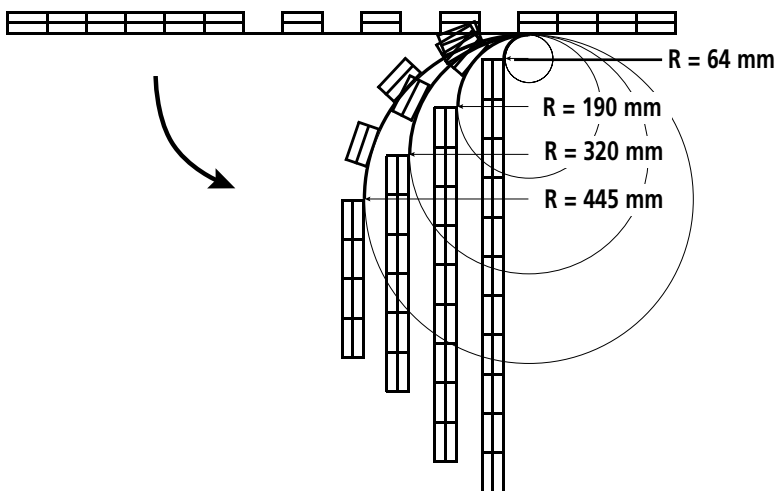
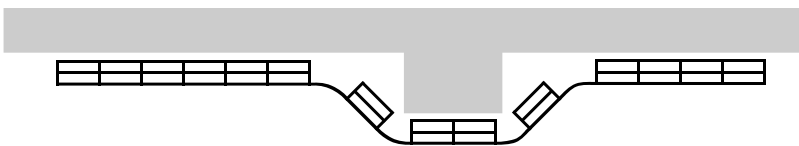
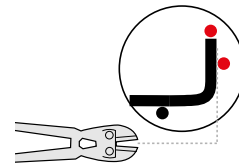
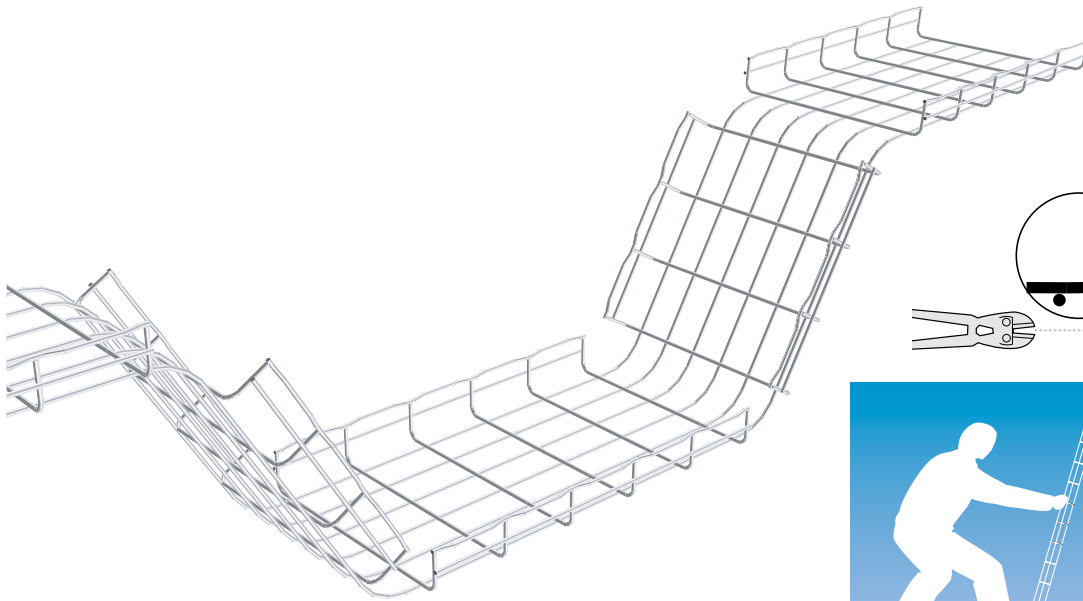

CÓMO ORDENAR EL SISTEMA BAJO PISO DE CABLOFIL (UFS)

Planear y ordenar el sistema de instalación en el suelo es muy sencillo siguiendo los siguientes pasos:

Planeación:

1. Revisa el dibujo a escala de la instalación, definiendo el camino que planeas recorra el cable. Considera múltiples niveles de charola con la instalación.

2. Determina el número de cables necesarios a transportar. Una buena regla es tomar en cuenta 50% de espacio para futuras adiciones o cambios.

3. Ingresa a www.cablofil.com en la sección de “Cálculos de carga” para que determines el tamaño de charola considerando el peso de la carga. Se muy específico en el tipo de cable que instalaras para que dé resultado.

4. Determina la altura de la pata necesaria para cada nivel.

5. Confirma que el ancho de la charola es compatible con la pata que se seleccionó. El largo del EDF en los sistemas de instalación en el suelo, soportan múltiples niveles de charola, sin embargo charolas de 50 mm solo pueden ser usadas cuando la barra transversal será instalada en la parte superior de cualquier pata.

Compra:

1. Determina la fuerza necesaria que la charola necesita. Considera las opciones del largo. Ahorra mano de obra y utiliza secciones de 3 metros cuando la charola sea instalada antes de la instalación de suelo. Si el suelo ya se instaló utiliza secciones de 600 mm.

2. Determina el número de kits de soporte necesarios para cada nivel de charola. Instala el soporte en cada unión si son charolas de 600 mm. Para tramos de 3 metros, los soportes son usados cada 2,4 metros. Para las terminaciones serán necesarios soportes adicionales, al igual que en las esquinas en T.

3. Cuenta el número de esquinas de 90° y en forma de T. El kit UFS90KIT funciona con cualquier ancho o profundidad de charola.

4. Envía la lista completa de los materiales necesarios y una copia de los planos de la construcción a tu representante Cablofil.

Diagrama A

Ejemplo de un sistema de charola en el suelo de 12' x 12' en suelo falso levantado



Diagrama B

Ejemplo de instalación con múltiples niveles

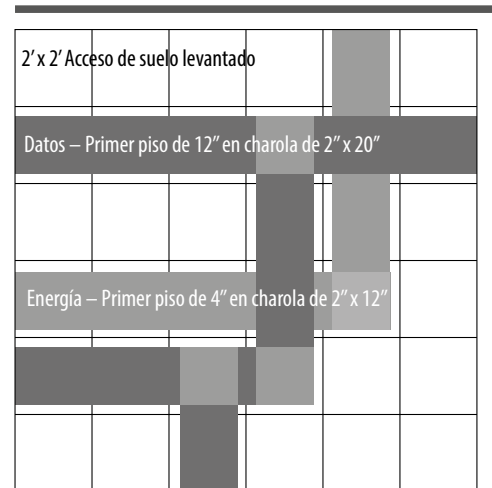

Diagrama C

Ejemplo de cuenta de materiales

	Cantidad	Código
Cables de datos		
	10	UFCF2/54/500
	17	UFSUPKIT300
	3	UFS90KIT
Cables de energía		
	7	UFC2/54/500
	10	UFSUPKIT100
	1	UFS90KIT

CÓMO INSTALAR EL SISTEMA BAJO PISO DE CABLOFIL (UFS)

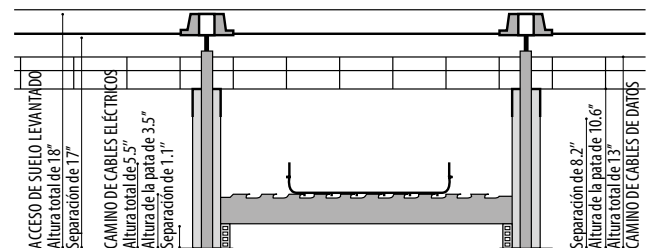

1. Monta las dos patas a la barra transversal.



2. Utiliza el tornillo para asegurar el montaje doblando la pequeña pestaña en cada pata.



3. Coloca las dos patas montadas y asegúralas con el clip.

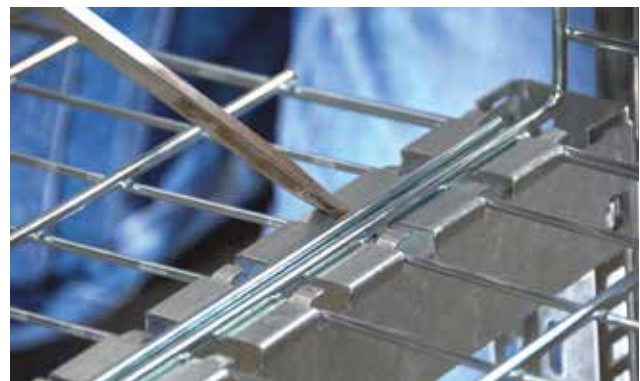

4. Coloca la charola de 600 mm en posición.



5. Dobla las pestañas del sistema FAS con un destornillador para asegurar la charola.



6. Utiliza un kit UFS90KIT para las esquinas y uniones y asegúralos con clips para charola.



		Ø	EZ	DC	304L	316L
--	-----------------------------------------------------------------------------------	---	----	----	------	------

BTRCC



BTRCC 1/4"	50	1/4"	941 084	-	-	941 059
BTRCC 6X20	100	6 mm		801 017	801 018	

CA



CA 8x75	50	-	801 051	801 057	-	801 054
----------------	----	---	---------	---------	---	---------



COUPFILGM	1	-	-	-	-	559 507
------------------	---	---	---	---	---	---------



CUTY-FIL	1	-	-	-	-	559 548
-----------------	---	---	---	---	---	---------

		L1 mm	EZ	GC	304L	316L
--	-------------------------------------------------------------------------------------	----------	----	----	------	------

**ED 275
ED 1100**

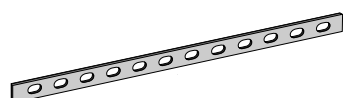

ED 275	50	275	558 221	558 223	558 228	558 224
---------------	----	-----	---------	---------	---------	---------

ED 1100	1	1100	558 201	558 203	-	558 204
----------------	---	------	---------	---------	---	---------



FASTRUT FS41

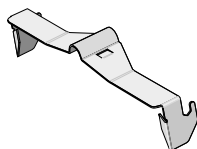

		GS	DC	304L	316L
FS41	50	-	599 007	-	599 004

CE30

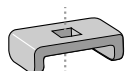

CE25



CE40



		EZ	DC	304L	316L
CE25	50	558 011	558 013	558 018	558 014
CE30	50	558 041	558 043	558 048	558 044
CE40	25	558 051	558 053	558 058	558 054

FASLOCK



		GS	DC	304L	316L
FASLOCK S	25	558 340	558 347	-	558 344
FASLOCK XL	25	558 320	558 327	-	558 324



Índice

83-108		
Charola de aluminio	Características generales	83
	Tramo recto	85
	Accesorios de direccionamiento	86
	Tramo recto de fondo sólido y perforado	98
	Accesorios de direccionamiento de charola de fondo sólido y fondo sólido perforado	99
	Tapas para tramo recto	100
	Tapas para accesorios	101
	Accesorios de complemento	102
	Instalación de charola de aluminio	108

CHAROLA DE ALUMINIO

El sistema de soporte tipo charola es estructura rígida y continua, construida para soportar cables, tubos u otras canalizaciones con cumplimiento de las normas NMX-J-511-ANCE-1999 Y CFE 57000-59.



Las charolas de la línea BTICINOMACSE se fabrican en aluminio 6063, temple 6 en perfil Z y están disponibles en tipo escalerilla, fondo sólido y fondo sólido perforado para los diferentes requerimientos de

instalación. La oferta incluye tramos rectos diseñados en longitudes de 3.66 mts. con peraltes entre 3 1/4" hasta 6". Además cuenta con una amplia gama de accesorios.

■ ESPECIFICACIÓN DE LA CHAROLA

Características	Descripciones
Material	Aluminio
Longitud	3.66 mts (12')
Perfil	Tipo "Z"
Calibre estándar	14
Calibre ligero	16
Opciones especiales	Fondo sólido Fondo sólido perforado

Peraltes	Peralte Nominal	Peralte Útil
Peralte estándar	3 1/4" (83 mm)	2 1/4" (57 mm)
	4" (102 mm)	3" (76 mm)
	4.5" (114 mm)	3.5" (89 mm)
Peraltes especiales	5" (127 mm)	4" (102 mm)
	6" (152 mm)	5" (127 mm)

■ ESPECIFICACIÓN DEL ALUMINIO

Características	Descripciones
Calibre	14 ó 16
Alineación	6063
Temple (Tramos rectos)	6
Temple (Accesorios)	52

■ APLICACIONES Y VENTAJAS

La charola de aluminio permite el montaje de todos los cables y canalizaciones avalados por la Norma Oficial Mexicana. Los materiales de fabricación le dan a la charola

mayor resistencia a la carga, no presenta problemas de corrosión y su fabricación nacional permite una disponibilidad inmediata del producto.

CHAROLA DE ALUMINIO

■ **TABLA A1**

Clasificación de Charolas por su construcción	Clasificación por capacidad de carga	Clasificación de soporte tipo charola para cable	Claro entre apoyos (mts)	Capacidad de carga (kg/m)
TIPO CANAL	BAJA	5AA	1.5	18.6
		5BB	1.5	37.2
		6AA	1.8	18.6
		6BB	1.8	37.2
TIPO ESCALERA	MEDIA	6A	1.8	74.4
		6B	1.8	111.6
6C		1.8	148.8	
8A		2.4	74.4	
8B		2.4	111.6	
8C		2.4	148.8	
TIPO FONDO VENTILADO	ALTA	12A	3.6	74.4
		12B	3.6	111.6
12C		3.6	148.8	
16A		4.8	74.4	
16B		4.8	111.6	
16C		4.8	148.8	
20A		6.1	74.4	
20B		6.1	111.6	
20C		6.1	148.8	

Tomado de la norma mexicana NMX-J-511-ANCE-1999.

Los productos BTICINOMACSE cumplen con las clasificaciones marcadas en naranja, según el tipo de producto.

NOTA: La capacidad de carga mecánica es para cables y canalizaciones. Ver apéndice A cuando se consideren aplicaciones que requieran carga estática concentrada.

■ **APÉNDICE A**

Conversión de carga estática concentrada a carga uniforme

Las concentraciones de carga estática representan una masa estática aplicada entre los elementos laterales a la mitad del claro entre apoyos.

La carga estática concentrada puede ser convertida en su equivalente de carga uniforme (Mu) en kg/m, usando la siguiente ecuación:

$$Mu = 2 (cec) / ca$$

En donde:

- Mu es la carga uniforme
- cec es la carga estática concentrada
- ca es el claro entre apoyos

Cuando en un soporte tipo charola para cables existe una carga concentrada, su carga uniforme equivalente debe sumarse a la carga estática de los cables para seleccionar el soporte tipo charola para cables adecuados.

■ **CERTIFICADOS**



TRAMO RECTO

Longitud 3.66 mts. (12')

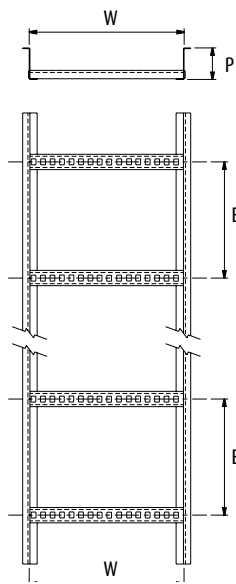

Codificación

MTR	- WW	EE	_ **	
Tipo de producto	Ancho	Espacio entre travesaños	Características especiales	
	04	06	(vacío)	Peralte 3/4" (83 mm) → 8C
	06	09	P4	Peralte 4" (102 mm) → 12A
	09	12	P4.5	Peralte 4.5" (114 mm) → 12A
	12	18	P5	Peralte 5" (127 mm) → 12A
	16		P6	Peralte 6" (152 mm) → 12A
	18		E	Calibre 16 (Aplica sólo para peralte 3/4")
	20			
	24			
	30			
	36			

*Charolas de peralte 3/4" con espacio entre travesaños de 18" son clasificación 8B.

TRAMO RECTO ESCALERA

Ancho (W)		Espacio de travesaños (E)		Código
mm	pul	mm	pul	
102	4	152	6	MTR-0406
		229	9	MTR-0409
		305	12	MTR-0412
		457	18	MTR-0418
152	6	152	6	MTR-0606
		229	9	MTR-0609
		305	12	MTR-0612
		457	18	MTR-0618
229	9	152	6	MTR-0906
		229	9	MTR-0909
		305	12	MTR-0912
		457	18	MTR-0918
305	12	152	6	MTR-1206
		229	9	MTR-1209
		305	12	MTR-1212
		457	18	MTR-1218
406	16	152	6	MTR-1606
		229	9	MTR-1609
		305	12	MTR-1612
		457	18	MTR-1618
457	18	152	6	MTR-1806
		229	9	MTR-1809
		305	12	MTR-1812
		457	18	MTR-1818
508	20	152	6	MTR-2006
		229	9	MTR-2009
		305	12	MTR-2012
		457	18	MTR-2018
610	24	152	6	MTR-2406
		229	9	MTR-2409
		305	12	MTR-2412
		457	18	MTR-2418
762	30	152	6	MTR-3006
		229	9	MTR-3009
		305	12	MTR-3012
		457	18	MTR-3018
914	36	152	6	MTR-3606
		229	9	MTR-3609
		305	12	MTR-3612
		457	18	MTR-3618

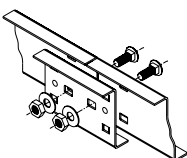

Producto calibre 16 (NEMA 8A) incluye dos conectores **rápidos** tipo "Z" y la tornillería requerida para su unión.
 Productos con otros calibres y/o peraltes incluyen dos conectores tradicionales tipo "Z" y la tornillería correspondiente.
 Cumplimiento de las normas NMX-J-511-ANCE-1999 y CFE 57000-59.

ACCESORIOS DE DIRECCIONAMIENTO

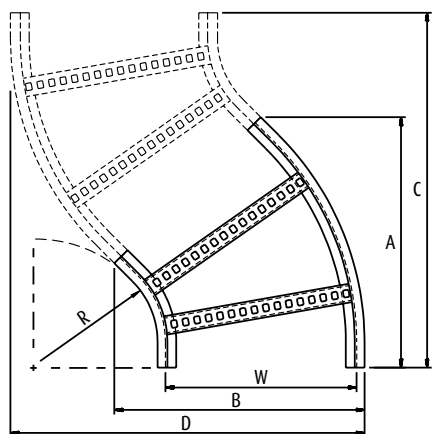
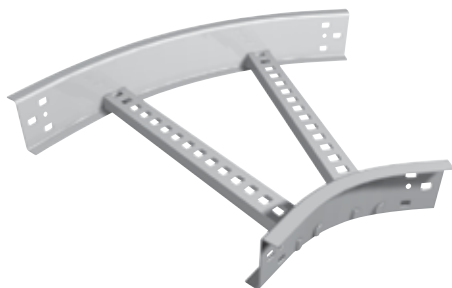

CURVA HORIZONTAL A 45°

Ancho (W)	Radio (R)		A		B		C		D		Código	
	mm	pul	mm	pul	mm	pul	mm	pul	mm	pul		
102	4	203	8	302	11 7/8	194	7 5/8	533	21	324	12 3/4	MCH-0408-45
		305	12	375	14 3/4	229	9	676	26 5/8	384	15 1/8	MCH-0412-45
		610	24	591	23 1/4	318	12 1/2	1111	43 3/4	562	22 1/8	MCH-0424-45
		762	30	699	27 1/2	362	14 1/4	1327	52 1/4	651	25 5/8	MCH-0430-45
152	6	914	36	803	31 5/8	406	16	1546	60 7/8	743	29 1/4	MCH-0436-45
		203	8	337	13 1/4	244	9 5/8	568	22 3/8	387	15 1/4	MCH-0608-45
		305	12	410	16 1/8	276	10 7/8	711	28	448	17 5/8	MCH-0612-45
		610	24	625	24 5/8	368	14 1/2	1143	45	629	24 3/4	MCH-0624-45
229	9	762	30	733	28 7/8	413	16 1/4	1362	53 5/8	721	28 3/8	MCH-0630-45
		914	36	841	33 1/8	460	18 1/8	1575	62	810	31 7/8	MCH-0636-45
		203	8	389	15 1/3	321	12 5/8	622	24 1/2	489	19 1/4	MCH-0908-45
		305	12	464	18 1/4	352	13 7/8	765	30 1/8	546	21 1/2	MCH-0912-45
305	12	610	24	679	26 3/4	445	17 1/2	1197	47 1/8	727	28 5/8	MCH-0924-45
		762	30	787	31	489	19 1/4	1419	55 7/8	819	32 1/4	MCH-0930-45
		914	36	895	35 1/4	537	21 1/8	1629	64 1/8	908	35 3/4	MCH-0936-45
		203	8	445	17 1/2	397	15 5/8	676	26 5/8	587	23 1/8	MCH-1208-45
406	16	305	12	518	20 3/8	429	16 7/8	819	32 1/4	645	25 3/8	MCH-1212-45
		610	24	733	28 7/8	521	20 1/2	1251	49 1/4	826	32 1/2	MCH-1224-45
		762	30	841	33 1/8	565	22 1/4	1473	58	918	36 1/8	MCH-1230-45
		914	36	949	37 3/8	613	24 1/8	1683	66 1/4	1006	39 5/8	MCH-1236-45
457	18	203	8	518	20 3/8	498	19 5/8	749	29 1/2	718	28 1/4	MCH-1608-45
		305	12	591	23 1/4	530	20 7/8	898	35 1/3	775	30 1/2	MCH-1612-45
		610	24	803	31 5/8	622	24 1/2	1327	52 1/4	956	37 5/8	MCH-1624-45
		762	30	914	36	667	26 1/4	1546	60 7/8	1051	41 3/8	MCH-1630-45
508	20	914	36	1022	40 1/4	711	28	1762	69 3/8	1140	44 7/8	MCH-1636-45
		203	8	556	21 7/8	549	21 5/8	787	31	787	31	MCH-1808-45
		305	12	625	24 5/8	581	22 7/8	927	36 1/2	841	33 1/8	MCH-1812-45
		610	24	841	33 1/8	673	26 1/2	1359	53 1/2	1022	40 1/4	MCH-1824-45
580	24	762	30	949	37 3/8	718	28 1/4	1581	62 1/4	1114	43 7/8	MCH-1830-45
		914	36	1057	41 5/8	765	30 1/8	1791	70 1/2	1203	47 3/8	MCH-1836-45
		203	8	591	23 1/4	600	23 5/8	822	32 3/8	851	33 1/2	MCH-2008-45
		305	12	660	26	635	25	965	38	911	35 7/8	MCH-2012-45
610	24	610	24	879	34 5/8	724	28 1/2	1397	55	1092	43	MCH-2024-45
		762	30	987	38 7/8	768	30 1/4	1616	63 5/8	1181	46 1/2	MCH-2030-45
		914	36	1095	43 1/8	813	32	1832	72 1/8	1270	50	MCH-2036-45
		203	8	660	26	702	27 5/8	895	35 1/4	981	38 5/8	MCH-2408-45
762	30	305	12	733	28 7/8	733	28 7/8	1035	40 3/4	1035	40 3/4	MCH-2412-45
		610	24	949	37 3/8	826	32 1/2	1467	57 3/4	1216	47 7/8	MCH-2424-45
		762	30	1057	41 5/8	870	34 1/4	1689	66 1/2	1311	51 5/8	MCH-2430-45
		914	36	1165	45 7/8	918	36 1/8	1899	74 3/4	1397	55	MCH-2436-45
810	36	203	8	772	30 3/8	854	33 5/8	1003	39 1/2	1181	46 1/2	MCH-3008-45
		305	12	841	33 1/8	886	34 7/8	1143	45	1232	48 1/2	MCH-3012-45
		610	24	1057	41 5/8	978	38 1/2	1575	62	1413	55 5/8	MCH-3024-45
		762	30	1168	46	1022	40 1/4	1794	70 5/8	1524	60	MCH-3030-45
914	36	914	36	1273	50 1/8	1070	42 1/8	2007	79	1594	62 3/4	MCH-3036-45
		203	8	879	34 5/8	1006	39 5/8	1133	44 5/8	1378	54 1/4	MCH-3608-45
		305	12	949	37 3/8	1038	40 7/8	1251	49 1/4	1429	56 1/4	MCH-3612-45
		610	24	1165	45 7/8	1130	44 1/2	1683	66 1/4	1610	63 3/8	MCH-3624-45
914	36	762	30	1273	50 1/8	1175	46 1/4	1905	75	1708	67 1/4	MCH-3630-45
		914	36	1381	54 3/8	1222	48 1/8	2115	83 1/4	1791	70 1/2	MCH-3636-45

Codificación

MCH -WW RR -45 -**

Tipo de producto	Ancho	Radio de curvatura	° de curva	Características especiales
04	08	(vacío)		Peralte 3 1/4" (83 mm)
06	12	P4		Peralte 4" (102 mm)
09	24	P4.5		Peralte 4.5" (114 mm)
12	30	P5		Peralte 5" (127 mm)
16	36	P6		Peralte 6" (152 mm)
18		E		Calibre 16 (Aplica sólo para peralte 3 1/4")
20				
24				
30				
36				

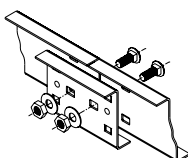

Producto calibre 16 (NEMA 8A) incluye dos conectores rápidos tipo "Z" y la tornillería requerida para su unión.
 Productos con otros calibres y/o peraltes incluyen dos conectores tradicionales tipo "Z" y la tornillería correspondiente.

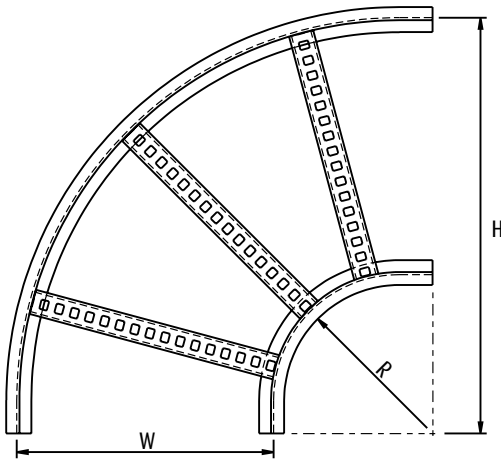

CURVA HORIZONTAL A 90°

Ancho (W)	Radio (R)		Altura (H)		Código	
	mm	pul	mm	pul		
102	4	203	8	356	14	MCH-0408-90
		305	12	457	18	MCH-0412-90
		610	24	762	30	MCH-0424-90
		762	30	914	36	MCH-0430-90
		914	36	1067	42	MCH-0436-90
152	6	203	8	406	16	MCH-0608-90
		305	12	508	20	MCH-0612-90
		610	24	813	32	MCH-0624-90
		762	30	965	38	MCH-0630-90
		914	36	1118	44	MCH-0636-90
229	9	203	8	483	19	MCH-0908-90
		305	12	584	23	MCH-0912-90
		610	24	889	35	MCH-0924-90
		762	30	1041	41	MCH-0930-90
		914	36	1194	47	MCH-0936-90
305	12	203	8	559	22	MCH-1208-90
		305	12	660	26	MCH-1212-90
		610	24	965	38	MCH-1224-90
		762	30	1118	44	MCH-1230-90
		914	36	1270	50	MCH-1236-90
406	16	203	8	660	26	MCH-1608-90
		305	12	762	30	MCH-1612-90
		610	24	1067	42	MCH-1624-90
		762	30	1219	48	MCH-1630-90
		914	36	1372	54	MCH-1636-90
457	18	203	8	711	28	MCH-1808-90
		305	12	813	32	MCH-1812-90
		610	24	1118	44	MCH-1824-90
		762	30	1270	50	MCH-1830-90
		914	36	1422	56	MCH-1836-90
508	20	203	8	762	30	MCH-2008-90
		305	12	864	34	MCH-2012-90
		610	24	1168	46	MCH-2024-90
		762	30	1321	52	MCH-2030-90
		914	36	1473	58	MCH-2036-90
610	24	203	8	864	34	MCH-2408-90
		305	12	965	38	MCH-2412-90
		610	24	1270	50	MCH-2424-90
		762	30	1422	56	MCH-2430-90
		914	36	1575	62	MCH-2436-90
762	30	203	8	1016	40	MCH-3008-90
		305	12	1118	44	MCH-3012-90
		610	24	1422	56	MCH-3024-90
		762	30	1575	62	MCH-3030-90
		914	36	1727	68	MCH-3036-90
914	36	203	8	1168	46	MCH-3608-90
		305	12	1270	50	MCH-3612-90
		610	24	1575	62	MCH-3624-90
		762	30	1727	68	MCH-3630-90
		914	36	1880	74	MCH-3636-90

Codificación

MCH	- WW	RR	- 90	- **
Tipo de producto	Ancho	Radio de curvatura	° de curva	Características especiales
	04	08		(vacío) Peralte 3¼" (83 mm)
	06	12		P4 Peralte 4" (102 mm)
	09	24		P4.5 Peralte 4.5" (114 mm)
	12	30		P5 Peralte 5" (127 mm)
	16	36		P6 Peralte 6" (152 mm)
	18			E Calibre 16 (Aplica sólo para peralte 3¼")
	20			
	24			
	30			
	36			

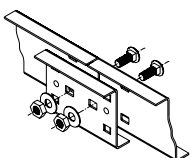

Producto calibre 16 (NEMA 8A) incluye dos conectores **rápidos** tipo "Z" y la tornillería requerida para su unión.
 Productos con otros calibres y/o peraltes incluyen dos conectores tradicionales tipo "Z" y la tornillería correspondiente.

ACCESORIOS DE DIRECCIONAMIENTO

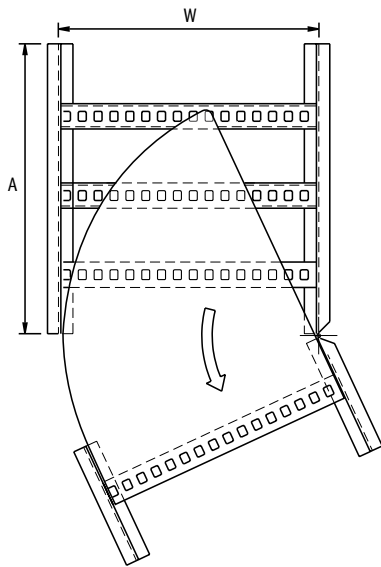

CURVA HORIZONTAL AJUSTABLE

Ancho (W)		Largo (A)		Código
mm	pul	mm	pul	
102	4	560	22	MCA-04
152	6	560	22	MCA-06
229	9	560	22	MCA-09
305	12	560	22	MCA-12
406	16	560	22	MCA-16
457	18	560	22	MCA-18
508	20	560	22	MCA-20
610	24	560	22	MCA-24
762	30	560	22	MCA-30
914	36	560	22	MCA-36

Codificación

MCA - WW - **

Tipo de producto	Ancho	Características especiales
	04	(vacío) Peralte 3¼" (83 mm)
	06	P4 Peralte 4" (102 mm)
	09	P4.5 Peralte 4.5" (114 mm)
	12	P5 Peralte 5" (127 mm)
	16	P6 Peralte 6" (152 mm)
	18	E Calibre 16 (Aplica sólo para peralte 3¼")
	20	
	24	
	30	
	36	

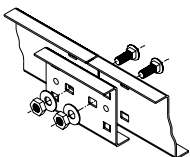

Producto calibre 16 (NEMA 8A) incluye dos conectores **rápidos** tipo "Z" y la tornillería requerida para su unión.
 Productos con otros calibres y/o peraltes incluyen dos conectores tradicionales tipo "Z" y la tornillería correspondiente.

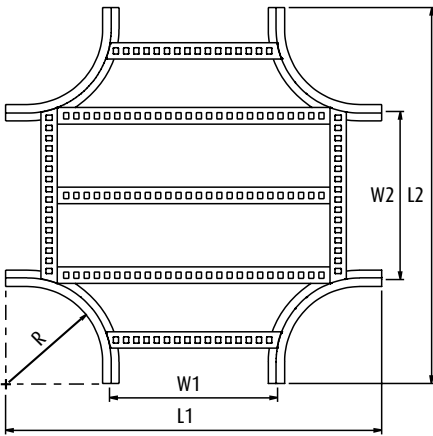

“X” HORIZONTAL

Ancho centro (W1=W2)		Largo (L1=L2)		Radio (R)		Código
mm	pul	mm	pul	mm	pul	
102	4	610	24	203	8	MXH-0404-8
152	6	660	26			MXH-0606-8
229	9	737	29			MXH-0909-8
305	12	813	32			MXH-1212-8
406	16	914	36			MXH-1616-8
457	18	965	38			MXH-1818-8
508	20	1016	40			MXH-2020-8
610	24	1118	44			MXH-2424-8
762	30	1270	50			MXH-3030-8
914	36	1422	56			MXH-3636-8
102	4	813	32	305	12	MXH-0404-12
152	6	864	34			MXH-0606-12
229	9	940	37			MXH-0909-12
305	12	1016	40			MXH-1212-12
406	16	1118	44			MXH-1616-12
457	18	1168	46			MXH-1818-12
508	20	1219	48			MXH-2020-12
610	24	1321	52			MXH-2424-12
762	30	1473	58			MXH-3030-12
914	36	1626	64			MXH-3636-12
102	4	1422	56	610	24	MXH-0404-24
152	6	1473	58			MXH-0606-24
229	9	1549	61			MXH-0909-24
305	12	1626	64			MXH-1212-24
406	16	1727	68			MXH-1616-24
457	18	1778	70			MXH-1818-24
508	20	1829	72			MXH-2020-24
610	24	1930	76			MXH-2424-24
762	30	2083	82			MXH-3030-24
914	36	2235	88			MXH-3636-24
102	4	1727	68	762	30	MXH-0404-30
152	6	1778	70			MXH-0606-30
229	9	1854	73			MXH-0909-30
305	12	1930	76			MXH-1212-30
406	16	2032	80			MXH-1616-30
457	18	2083	82			MXH-1818-30
508	20	2134	84			MXH-2020-30
610	24	2235	88			MXH-2424-30
762	30	2388	94			MXH-3030-30
914	36	2540	100			MXH-3636-30
102	4	2032	80	914	36	MXH-0404-36
152	6	2083	82			MXH-0606-36
229	9	2159	85			MXH-0909-36
305	12	2235	88			MXH-1212-36
406	16	2337	92			MXH-1616-36
457	18	2388	94			MXH-1818-36
508	20	2438	96			MXH-2020-36
610	24	2540	100			MXH-2424-36
762	30	2692	106			MXH-3030-36
914	36	2845	112			MXH-3636-36

Codificación

MXH	- W1	W2	- RR	- **
Tipo de producto	Ancho Centro	Ancho Extremos	Radio	Características especiales
	04	04	8	(vacío) Peralte 3¼" (83 mm)
	06	06	12	P4 Peralte 4" (102 mm)
	09	09	24	P4.5 Peralte 4.5" (114 mm)
	12	12	30	P5 Peralte 5" (127 mm)
	16	16	36	P6 Peralte 6" (152 mm)
	18	18		E Calibre 16 (Aplica sólo para peralte 3¼")
	20	20		
	24	24		
	30	30		
	36	36		

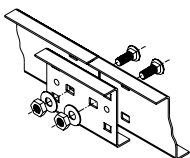

Producto calibre 16 (NEMA 8A) incluye dos conectores rápidos tipo "Z" y la tornillería requerida para su unión. Productos con otros calibres y/o peraltes incluyen dos conectores tradicionales tipo "Z" y la tornillería correspondiente.

ACCESORIOS DE DIRECCIONAMIENTO

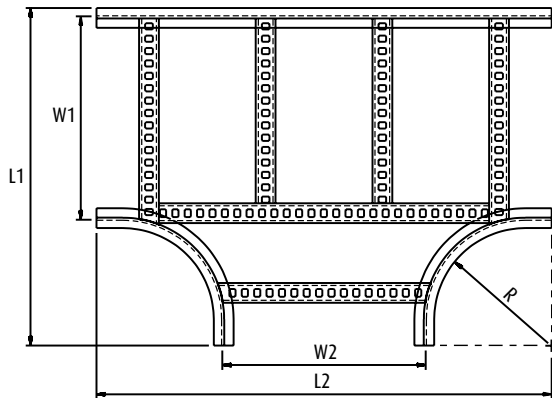

Codificación

MTH	- W1	W2	- RR	- **	
Tipo de producto	Ancho Centro	Ancho Extremos	Radio	Características especiales	
	04	04	8	(vacío)	Peralte 3¼" (83 mm)
	06	06	12	P4	Peralte 4" (102 mm)
	09	09	24	P4.5	Peralte 4.5" (114 mm)
	12	12	30	P5	Peralte 5" (127 mm)
	16	16	36	P6	Peralte 6" (152 mm)
	18	18		E	Calibre 16 (Aplica sólo para peralte 3¼")
	20	20			
	24	24			
	30	30			
	36	36			

"T" HORIZONTAL

Ancho extremos (W1=W2)		Largo extremos (L1)		Largo Centro (L2)		Radio (R)		Código
mm	pul	mm	pul	mm	pul	mm	pul	
102	4	356	14	610	24			MTH-0404-8
152	6	406	16	660	26			MTH-0606-8
229	9	483	19	737	29			MTH-0909-8
305	12	559	22	813	32			MTH-1212-8
406	16	660	26	914	36	203	8	MTH-1616-8
457	18	711	28	965	38			MTH-1818-8
508	20	762	30	1016	40			MTH-2020-8
610	24	864	34	1118	44			MTH-2424-8
762	30	1016	40	1270	50			MTH-3030-8
914	36	1168	46	1422	56			MTH-3636-8
102	4	457	18	813	32			MTH-0404-12
152	6	508	20	864	34			MTH-0606-12
229	9	584	23	940	37			MTH-0909-12
305	12	660	26	1016	40			MTH-1212-12
406	16	762	30	1118	44	305	12	MTH-1616-12
457	18	813	32	1168	46			MTH-1818-12
508	20	864	34	1219	48			MTH-2020-12
610	24	965	38	1321	52			MTH-2424-12
762	30	1118	44	1473	58			MTH-3030-12
914	36	1270	50	1626	64			MTH-3636-12
102	4	762	30	1422	56			MTH-0404-24
152	6	813	32	1473	58			MTH-0606-24
229	9	889	35	1549	61			MTH-0909-24
305	12	965	38	1626	64			MTH-1212-24
406	16	1067	42	1727	68	610	24	MTH-1616-24
457	18	1118	44	1778	70			MTH-1818-24
508	20	1168	46	1829	72			MTH-2020-24
610	24	1270	50	1930	76			MTH-2424-24
762	30	1422	56	2083	82			MTH-3030-24
914	36	1575	62	2235	88			MTH-3636-24
102	4	914	36	1727	68			MTH-0404-30
152	6	965	38	1778	70			MTH-0606-30
229	9	1041	41	1854	73			MTH-0909-30
305	12	1118	44	1930	76			MTH-1212-30
406	16	1219	48	2032	80	762	30	MTH-1616-30
457	18	1270	50	2083	82			MTH-1818-30
508	20	1321	52	2134	84			MTH-2020-30
610	24	1422	56	2235	88			MTH-2424-30
762	30	1575	62	2388	94			MTH-3030-30
914	36	1727	68	2540	100			MTH-3636-30
102	4	1067	42	2032	80			MTH-0404-36
152	6	1118	44	2083	82			MTH-0606-36
229	9	1194	47	2159	85			MTH-0909-36
305	12	1270	50	2235	88			MTH-1212-36
406	16	1372	54	2337	92	914	36	MTH-1616-36
457	18	1422	56	2388	94			MTH-1818-36
508	20	1473	58	2438	96			MTH-2020-36
610	24	1575	62	2540	100			MTH-2424-36
762	30	1727	68	2692	106			MTH-3030-36
914	36	1880	74	2845	112			MTH-3636-36

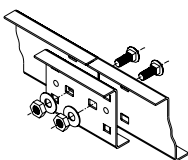

Producto calibre 16 (NEMA 8A) incluye dos conectores rápidos tipo "Z" y la tornillería requerida para su unión.
 Productos con otros calibres y/o peraltes incluyen dos conectores tradicionales tipo "Z" y la tornillería correspondiente.

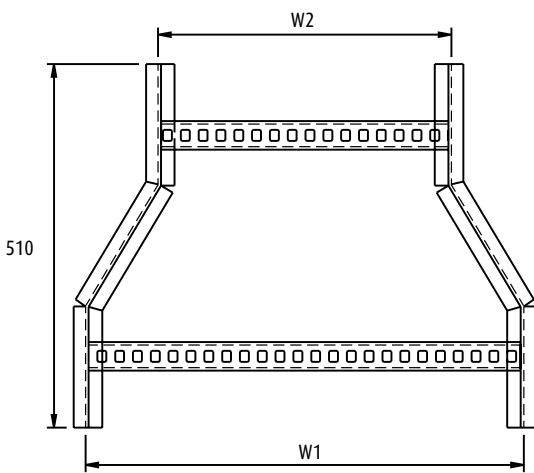
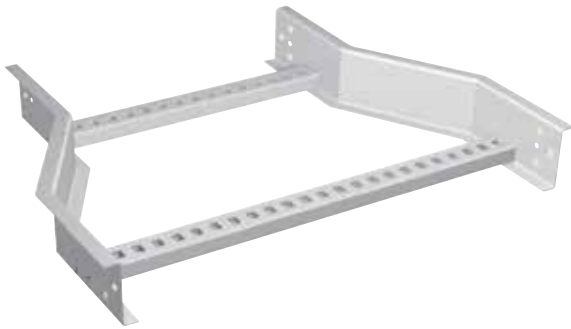

*Medidas en mm.

Codificación			
MRR	- W1	W2	- **
Tipo de producto	Ancho Centro	Ancho Extremos	Características especiales
	04	04	(vacío) Peralte 3/4" (83 mm)
	06	06	P4 Peralte 4" (102 mm)
	09	09	P4.5 Peralte 4.5" (114 mm)
	12	12	P5 Peralte 5" (127 mm)
	16	16	P6 Peralte 6" (152 mm)
	18	18	E Calibre 16 (Aplica sólo para peralte 3/4")
	20	20	
	24	24	
	30	30	
	36	36	

REDUCCIÓN RECTA

Ancho entrada (W1)		Ancho reducción (W2)		Código		
mm	pul	mm	pul			
914	36	762	30	MRR-3630		
		610	24	MRR-3624		
		508	20	MRR-3620		
		457	18	MRR-3618		
		406	16	MRR-3616		
		305	12	MRR-3612		
		229	9	MRR-3609		
		152	6	MRR-3606		
		102	4	MRR-3604		
		762	30	610	24	MRR-3024
508	20			MRR-3020		
457	18			MRR-3018		
406	16			MRR-3016		
305	12			MRR-3012		
229	9			MRR-3009		
152	6			MRR-3006		
102	4			MRR-3004		
610	24			508	20	MRR-2420
				457	18	MRR-2418
		406	16	MRR-2416		
		305	12	MRR-2412		
		229	9	MRR-2409		
		152	6	MRR-2406		
		102	4	MRR-2404		
		457	18	MRR-2018		
		406	16	MRR-2016		
		508	20	305	12	MRR-2012
229	9			MRR-2009		
152	6			MRR-2006		
102	4			MRR-2004		
406	16			MRR-1816		
305	12			MRR-1812		
229	9			MRR-1809		
152	6			MRR-1806		
102	4			MRR-1804		
406	16			305	12	MRR-1612
		229	9	MRR-1609		
		152	6	MRR-1606		
		102	4	MRR-1604		
305	12	229	9	MRR-1209		
		152	6	MRR-1206		
		102	4	MRR-1204		
229	9	152	6	MRR-0906		
		102	4	MRR-0904		
152	6	102	4	MRR-0604		

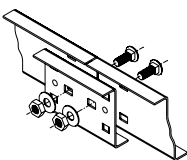

Producto calibre 16 (NEMA 8A) incluye dos conectores rápidos tipo "Z" y la tornillería requerida para su unión. Productos con otros calibres y/o peraltes incluyen dos conectores tradicionales tipo "Z" y la tornillería correspondiente.

ACCESORIOS DE DIRECCIONAMIENTO



Reducción derecha

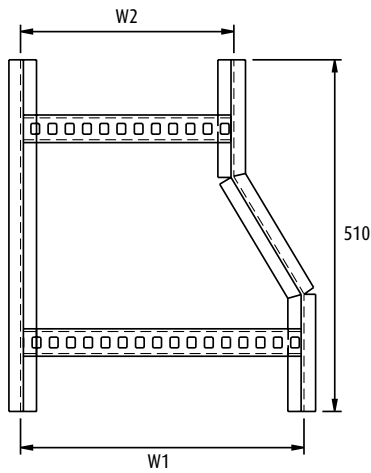

Reducción izquierda

*Medidas en mm.

Codificación				
MRL	-W1	W2	-YY	-**
Tipo de producto	Ancho Centro	Ancho Extremos	Lado de red	Características especiales
	04	04	D	(vacío) Peralte 3¼" (83 mm)
	06	06	I	P4 Peralte 4" (102 mm)
	09	09		P4.5 Peralte 4.5" (114 mm)
	12	12		P5 Peralte 5" (127 mm)
	16	16		P6 Peralte 6" (152 mm)
	18	18		E Calibre 16 (Aplica sólo para peralte 3¼")
	20	20		
	24	24		
	30	30		
	36	36		

REDUCCIÓN LATERAL

Ancho entrada (W1)		Ancho reducción (W2)		Código					
mm	pul	mm	pul	R. derecha	R. izquierda				
914	36	762	30	MRL-3630-D	MRL-3630-I				
		610	24	MRL-3624-D	MRL-3624-I				
		508	20	MRL-3620-D	MRL-3620-I				
		457	18	MRL-3618-D	MRL-3618-I				
		406	16	MRL-3616-D	MRL-3616-I				
		305	12	MRL-3612-D	MRL-3612-I				
		229	9	MRL-3609-D	MRL-3609-I				
		152	6	MRL-3606-D	MRL-3606-I				
		102	4	MRL-3604-D	MRL-3604-I				
		762	30	610	24	MRL-3024-D	MRL-3024-I		
508	20			MRL-3020-D	MRL-3020-I				
457	18			MRL-3018-D	MRL-3018-I				
406	16			MRL-3016-D	MRL-3016-I				
305	12			MRL-3012-D	MRL-3012-I				
229	9			MRL-3009-D	MRL-3009-I				
152	6			MRL-3006-D	MRL-3006-I				
102	4			MRL-3004-D	MRL-3004-I				
610	24			508	20	MRL-2420-D	MRL-2420-I		
				457	18	MRL-2418-D	MRL-2418-I		
		406	16	MRL-2416-D	MRL-2416-I				
		305	12	MRL-2412-D	MRL-2412-I				
		229	9	MRL-2409-D	MRL-2409-I				
		152	6	MRL-2406-D	MRL-2406-I				
		102	4	MRL-2404-D	MRL-2404-I				
		508	20	457	18	MRL-2018-D	MRL-2018-I		
				406	16	MRL-2016-D	MRL-2016-I		
				305	12	MRL-2012-D	MRL-2012-I		
229	9			MRL-2009-D	MRL-2009-I				
152	6			MRL-2006-D	MRL-2006-I				
102	4			MRL-2004-D	MRL-2004-I				
457	18			406	16	MRL-1816-D	MRL-1816-I		
				305	12	MRL-1812-D	MRL-1812-I		
				229	9	MRL-1809-D	MRL-1809-I		
				152	6	MRL-1806-D	MRL-1806-I		
		102	4	MRL-1804-D	MRL-1804-I				
		406	16	305	12	MRL-1612-D	MRL-1612-I		
				229	9	MRL-1609-D	MRL-1609-I		
				152	6	MRL-1606-D	MRL-1606-I		
				102	4	MRL-1604-D	MRL-1604-I		
				305	12	229	9	MRL-1209-D	MRL-1209-I
152	6					MRL-1206-D	MRL-1206-I		
102	4					MRL-1204-D	MRL-1204-I		
229	9					152	6	MRL-0906-D	MRL-0906-I
						102	4	MRL-0904-D	MRL-0904-I
						152	6	102	4

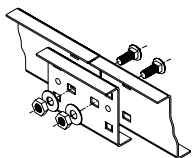

Producto calibre 16 (NEMA 8A) incluye dos conectores rápidos tipo "Z" y la tornillería requerida para su unión.
 Productos con otros calibres y/o peraltes incluyen dos conectores tradicionales tipo "Z" y la tornillería correspondiente.

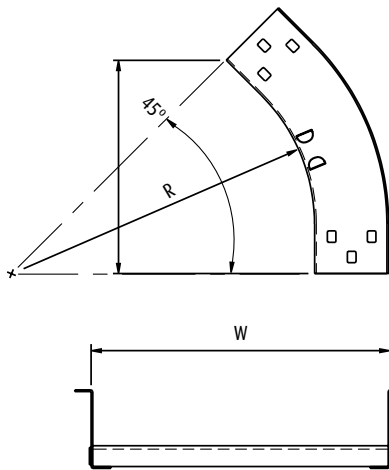
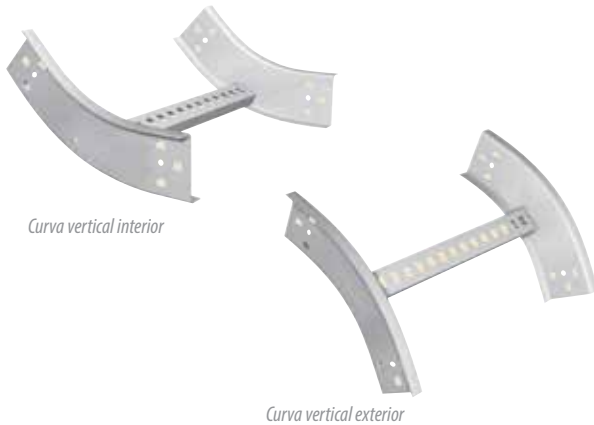

CURVA VERTICAL EXTERIOR E INTERIOR A 45°

Ancho (W)	Radio (R)		Código		
	mm	pul	Curva exterior	Curva interior	
102	4	203	8	MVE-0408-45	MVI-0408-45
		305	12	MVE-0412-45	MVI-0412-45
		610	24	MVE-0424-45	MVI-0424-45
		762	30	MVE-0430-45	MVI-0430-45
		914	36	MVE-0436-45	MVI-0436-45
152	6	203	8	MVE-0608-45	MVI-0608-45
		305	12	MVE-0612-45	MVI-0612-45
		610	24	MVE-0624-45	MVI-0624-45
		762	30	MVE-0630-45	MVI-0630-45
		914	36	MVE-0636-45	MVI-0636-45
229	9	203	8	MVE-0908-45	MVI-0908-45
		305	12	MVE-0912-45	MVI-0912-45
		610	24	MVE-0924-45	MVI-0924-45
		762	30	MVE-0930-45	MVI-0930-45
		914	36	MVE-0936-45	MVI-0936-45
305	12	203	8	MVE-1208-45	MVI-1208-45
		305	12	MVE-1212-45	MVI-1212-45
		610	24	MVE-1224-45	MVI-1224-45
		762	30	MVE-1230-45	MVI-1230-45
		914	36	MVE-1236-45	MVI-1236-45
406	16	203	8	MVE-1608-45	MVI-1608-45
		305	12	MVE-1612-45	MVI-1612-45
		610	24	MVE-1624-45	MVI-1624-45
		762	30	MVE-1630-45	MVI-1630-45
		914	36	MVE-1636-45	MVI-1636-45
457	18	203	8	MVE-1808-45	MVI-1808-45
		305	12	MVE-1812-45	MVI-1812-45
		610	24	MVE-1824-45	MVI-1824-45
		762	30	MVE-1830-45	MVI-1830-45
		914	36	MVE-1836-45	MVI-1836-45
508	20	203	8	MVE-2008-45	MVI-2008-45
		305	12	MVE-2012-45	MVI-2012-45
		610	24	MVE-2024-45	MVI-2024-45
		762	30	MVE-2030-45	MVI-2030-45
		914	36	MVE-2036-45	MVI-2036-45
610	24	203	8	MVE-2408-45	MVI-2408-45
		305	12	MVE-2412-45	MVI-2412-45
		610	24	MVE-2424-45	MVI-2424-45
		762	30	MVE-2430-45	MVI-2430-45
		914	36	MVE-2436-45	MVI-2436-45
762	30	203	8	MVE-3008-45	MVI-3008-45
		305	12	MVE-3012-45	MVI-3012-45
		610	24	MVE-3024-45	MVI-3024-45
		762	30	MVE-3030-45	MVI-3030-45
		914	36	MVE-3036-45	MVI-3036-45
914	36	203	8	MVE-3608-45	MVI-3608-45
		305	12	MVE-3612-45	MVI-3612-45
		610	24	MVE-3624-45	MVI-3624-45
		762	30	MVE-3630-45	MVI-3630-45
		914	36	MVE-3636-45	MVI-3636-45

Codificación					
MV*	-W1	RR	- 45	- **	
Tipo de producto	Ancho	Radio de curvatura	° de curva	Características especiales	
E	Curva exterior	04	08	(vacío)	Peralte 3¼" (83 mm)
		06	12	P4	Peralte 4" (102 mm)
		09	24	P4.5	Peralte 4.5" (114 mm)
I	Curva interior	12	30	P5	Peralte 5" (127 mm)
		16	36	P6	Peralte 6" (152 mm)
		18		E	Calibre 16 (Aplica sólo para peralte 3¼")
		20			
		24			
		30			

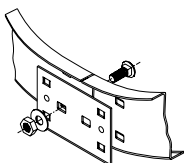

Incluye dos conectores rectos y la tornillería requerida para su unión.

ACCESORIOS DE DIRECCIONAMIENTO



Curva vertical interior

Curva vertical exterior

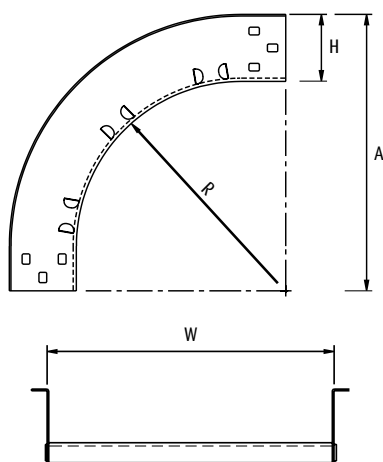

Codificación

MV*	- W1	RR	- 90	- **	
Tipo de producto	Ancho	Radio de curvatura	° de curva	Características especiales	
E	Curva exterior	04	08	(vacío)	Peralte 3¼" (83 mm)
		06	12	P4	Peralte 4" (102 mm)
		09	24	P4.5	Peralte 4.5" (114 mm)
I	Curva interior	12	30	P5	Peralte 5" (127 mm)
		16	36	P6	Peralte 6" (152 mm)
		18		E	Calibre 16 (Aplica sólo para peralte 3¼")
		20			
		24			
		30			
		36			

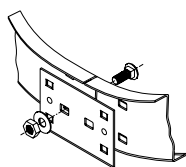

Incluye dos conectores rectos y la tornillería requerida para su unión.

CURVA VERTICAL EXTERIOR E INTERIOR A 90°

Ancho (W)	Radio (R)		Altura (A)		Código		
	mm	pul	mm	pul	Curva exterior	Curva interior	
102	4	203	8	H + 254	H + 10	MVE-0408-90	MVI-0408-90
		305	12	H + 356	H + 14	MVE-0412-90	MVI-0412-90
		610	24	H + 660	H + 26	MVE-0424-90	MVI-0424-90
		762	30	H + 813	H + 32	MVE-0430-90	MVI-0430-90
		914	36	H + 965	H + 38	MVE-0436-90	MVI-0436-90
152	6	203	8	H + 254	H + 10	MVE-0608-90	MVI-0608-90
		305	12	H + 356	H + 14	MVE-0612-90	MVI-0612-90
		610	24	H + 660	H + 26	MVE-0624-90	MVI-0624-90
		762	30	H + 813	H + 32	MVE-0630-90	MVI-0630-90
		914	36	H + 965	H + 38	MVE-0636-90	MVI-0636-90
229	9	203	8	H + 254	H + 10	MVE-0908-90	MVI-0908-90
		305	12	H + 356	H + 14	MVE-0912-90	MVI-0912-90
		610	24	H + 660	H + 26	MVE-0924-90	MVI-0924-90
		762	30	H + 813	H + 32	MVE-0930-90	MVI-0930-90
		914	36	H + 965	H + 38	MVE-0936-90	MVI-0936-90
305	12	203	8	H + 254	H + 10	MVE-1208-90	MVI-1208-90
		305	12	H + 356	H + 14	MVE-1212-90	MVI-1212-90
		610	24	H + 660	H + 26	MVE-1224-90	MVI-1224-90
		762	30	H + 813	H + 32	MVE-1230-90	MVI-1230-90
		914	36	H + 965	H + 38	MVE-1236-90	MVI-1236-90
406	16	203	8	H + 254	H + 10	MVE-1608-90	MVI-1608-90
		305	12	H + 356	H + 14	MVE-1612-90	MVI-1612-90
		610	24	H + 660	H + 26	MVE-1624-90	MVI-1624-90
		762	30	H + 813	H + 32	MVE-1630-90	MVI-1630-90
		914	36	H + 965	H + 38	MVE-1636-90	MVI-1636-90
457	18	203	8	H + 254	H + 10	MVE-1808-90	MVI-1808-90
		305	12	H + 356	H + 14	MVE-1812-90	MVI-1812-90
		610	24	H + 660	H + 26	MVE-1824-90	MVI-1824-90
		762	30	H + 813	H + 32	MVE-1830-90	MVI-1830-90
		914	36	H + 965	H + 38	MVE-1836-90	MVI-1836-90
508	20	203	8	H + 254	H + 10	MVE-2008-90	MVI-2008-90
		305	12	H + 356	H + 14	MVE-2012-90	MVI-2012-90
		610	24	H + 660	H + 26	MVE-2024-90	MVI-2024-90
		762	30	H + 813	H + 32	MVE-2030-90	MVI-2030-90
		914	36	H + 965	H + 38	MVE-2036-90	MVI-2036-90
610	24	203	8	H + 254	H + 10	MVE-2408-90	MVI-2408-90
		305	12	H + 356	H + 14	MVE-2412-90	MVI-2412-90
		610	24	H + 660	H + 26	MVE-2424-90	MVI-2424-90
		762	30	H + 813	H + 32	MVE-2430-90	MVI-2430-90
		914	36	H + 965	H + 38	MVE-2436-90	MVI-2436-90
762	30	203	8	H + 254	H + 10	MVE-3008-90	MVI-3008-90
		305	12	H + 356	H + 14	MVE-3012-90	MVI-3012-90
		610	24	H + 660	H + 26	MVE-3024-90	MVI-3024-90
		762	30	H + 813	H + 32	MVE-3030-90	MVI-3030-90
		914	36	H + 965	H + 38	MVE-3036-90	MVI-3036-90
914	36	203	8	H + 254	H + 10	MVE-3608-90	MVI-3608-90
		305	12	H + 356	H + 14	MVE-3612-90	MVI-3612-90
		610	24	H + 660	H + 26	MVE-3624-90	MVI-3624-90
		762	30	H + 813	H + 32	MVE-3630-90	MVI-3630-90
		914	36	H + 965	H + 38	MVE-3636-90	MVI-3636-90

H = Peralte

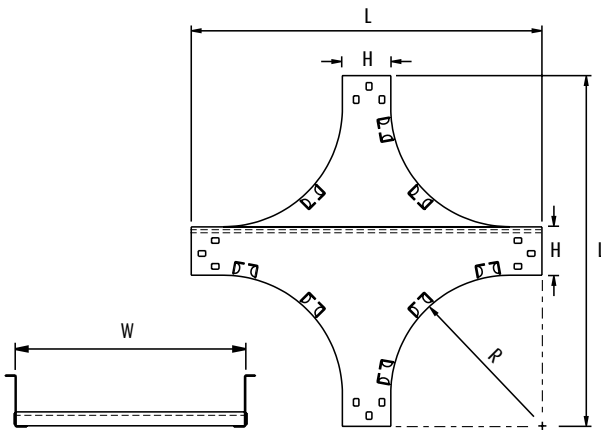

Codificación

MXV	- WW	RR	- **
Tipo de producto	Ancho	Radio de curvatura	Características especiales
	04	08	(vacío) Peralte 3/4" (83 mm)
	06	12	P4 Peralte 4" (102 mm)
	09	24	P4.5 Peralte 4.5" (114 mm)
	12	30	P5 Peralte 5" (127 mm)
	16	36	P6 Peralte 6" (152 mm)
	18		E Calibre 16 (Aplica sólo para peralte 3/4")
	20		
	24		
	30		
	36		

"X" VERTICAL

Ancho (W)	Radio (R)		Longitud (L)		Código	
	mm	pul	mm	pul		
102	4	203	8	H + 508	H + 20	MXV-0408
		305	12	H + 711	H + 28	MXV-0412
		610	24	H + 1321	H + 52	MXV-0424
		762	30	H + 1626	H + 64	MXV-0430
		914	36	H + 1930	H + 76	MXV-0436
152	6	203	8	H + 508	H + 20	MXV-0608
		305	12	H + 711	H + 28	MXV-0612
		610	24	H + 1321	H + 52	MXV-0624
		762	30	H + 1626	H + 64	MXV-0630
		914	36	H + 1930	H + 76	MXV-0636
229	9	203	8	H + 508	H + 20	MXV-0908
		305	12	H + 711	H + 28	MXV-0912
		610	24	H + 1321	H + 52	MXV-0924
		762	30	H + 1626	H + 64	MXV-0930
		914	36	H + 1930	H + 76	MXV-0936
305	12	203	8	H + 508	H + 20	MXV-1208
		305	12	H + 711	H + 28	MXV-1212
		610	24	H + 1321	H + 52	MXV-1224
		762	30	H + 1626	H + 64	MXV-1230
		914	36	H + 1930	H + 76	MXV-1236
406	16	203	8	H + 508	H + 20	MXV-1608
		305	12	H + 711	H + 28	MXV-1612
		610	24	H + 1321	H + 52	MXV-1624
		762	30	H + 1626	H + 64	MXV-1630
		914	36	H + 1930	H + 76	MXV-1636
457	18	203	8	H + 508	H + 20	MXV-1808
		305	12	H + 711	H + 28	MXV-1812
		610	24	H + 1321	H + 52	MXV-1824
		762	30	H + 1626	H + 64	MXV-1830
		914	36	H + 1930	H + 76	MXV-1836
508	20	203	8	H + 508	H + 20	MXV-2008
		305	12	H + 711	H + 28	MXV-2012
		610	24	H + 1321	H + 52	MXV-2024
		762	30	H + 1626	H + 64	MXV-2030
		914	36	H + 1930	H + 76	MXV-2036
610	24	203	8	H + 508	H + 20	MXV-2408
		305	12	H + 711	H + 28	MXV-2412
		610	24	H + 1321	H + 52	MXV-2424
		762	30	H + 1626	H + 64	MXV-2430
		914	36	H + 1930	H + 76	MXV-2436
762	30	203	8	H + 508	H + 20	MXV-3008
		305	12	H + 711	H + 28	MXV-3012
		610	24	H + 1321	H + 52	MXV-3024
		762	30	H + 1626	H + 64	MXV-3030
		914	36	H + 1930	H + 76	MXV-3036
914	36	203	8	H + 508	H + 20	MXV-3608
		305	12	H + 711	H + 28	MXV-3612
		610	24	H + 321	H + 52	MXV-3624
		762	30	H + 1626	H + 64	MXV-3630
		914	36	H + 1930	H + 76	MXV-3636

H = Peralte

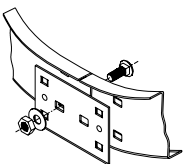

Incluye dos conectores rectos y la tornillería requerida para su unión.

ACCESORIOS DE DIRECCIONAMIENTO

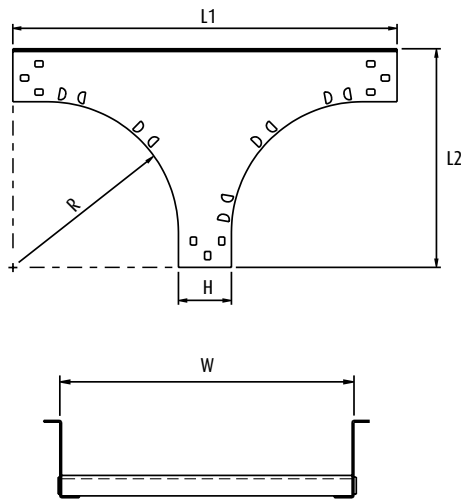

"T" VERTICAL

Ancho (W)	Radio (R)	Longitud (L1)		Longitud (L2)		Código		
		mm	pul	mm	pul			
102	4	203	8	H + 508	H + 20	H + 254	H + 10	MTV-0408
		305	12	H + 711	H + 28	H + 356	H + 14	MTV-0412
		610	24	H + 1321	H + 52	H + 660	H + 26	MTV-0424
		762	30	H + 1626	H + 64	H + 813	H + 32	MTV-0430
		914	36	H + 1930	H + 76	H + 965	H + 38	MTV-0436
152	6	203	8	H + 508	H + 20	H + 254	H + 10	MTV-0608
		305	12	H + 711	H + 28	H + 356	H + 14	MTV-0612
		610	24	H + 1321	H + 52	H + 660	H + 26	MTV-0624
		762	30	H + 1626	H + 64	H + 813	H + 32	MTV-0630
		914	36	H + 1930	H + 76	H + 965	H + 38	MTV-0636
229	9	203	8	H + 508	H + 20	H + 254	H + 10	MTV-0908
		305	12	H + 711	H + 28	H + 356	H + 14	MTV-0912
		610	24	H + 1321	H + 52	H + 660	H + 26	MTV-0924
		762	30	H + 1626	H + 64	H + 813	H + 32	MTV-0930
		914	36	H + 1930	H + 76	H + 965	H + 38	MTV-0936
305	12	203	8	H + 508	H + 20	H + 254	H + 10	MTV-1208
		305	12	H + 711	H + 28	H + 356	H + 14	MTV-1212
		610	24	H + 1321	H + 52	H + 660	H + 26	MTV-1224
		762	30	H + 1626	H + 64	H + 813	H + 32	MTV-1230
		914	36	H + 1930	H + 76	H + 965	H + 38	MTV-1236
406	16	203	8	H + 508	H + 20	H + 254	H + 10	MTV-1608
		305	12	H + 711	H + 28	H + 356	H + 14	MTV-1612
		610	24	H + 1321	H + 52	H + 660	H + 26	MTV-1624
		762	30	H + 1626	H + 64	H + 813	H + 32	MTV-1630
		914	36	H + 1930	H + 76	H + 965	H + 38	MTV-1636
457	18	203	8	H + 508	H + 20	H + 254	H + 10	MTV-1808
		305	12	H + 711	H + 28	H + 356	H + 14	MTV-1812
		610	24	H + 1321	H + 52	H + 660	H + 26	MTV-1824
		762	30	H + 1626	H + 64	H + 813	H + 32	MTV-1830
		914	36	H + 1930	H + 76	H + 965	H + 38	MTV-1836
508	20	203	8	H + 508	H + 20	H + 254	H + 10	MTV-2008
		305	12	H + 711	H + 28	H + 356	H + 14	MTV-2012
		610	24	H + 1321	H + 52	H + 660	H + 26	MTV-2024
		762	30	H + 1626	H + 64	H + 813	H + 32	MTV-2030
		914	36	H + 1930	H + 76	H + 965	H + 38	MTV-2036
610	24	203	8	H + 508	H + 20	H + 254	H + 10	MTV-2408
		305	12	H + 711	H + 28	H + 356	H + 14	MTV-2412
		610	24	H + 1321	H + 52	H + 660	H + 26	MTV-2424
		762	30	H + 1626	H + 64	H + 813	H + 32	MTV-2430
		914	36	H + 1930	H + 76	H + 965	H + 38	MTV-2436
762	30	203	8	H + 508	H + 20	H + 254	H + 10	MTV-3008
		305	12	H + 711	H + 28	H + 356	H + 14	MTV-3012
		610	24	H + 1321	H + 52	H + 660	H + 26	MTV-3024
		762	30	H + 1626	H + 64	H + 813	H + 32	MTV-3030
		914	36	H + 1930	H + 76	H + 965	H + 38	MTV-3036
914	36	203	8	H + 508	H + 20	H + 254	H + 10	MTV-3608
		305	12	H + 711	H + 28	H + 356	H + 14	MTV-3612
		610	24	H + 1321	H + 52	H + 660	H + 26	MTV-3624
		762	30	H + 1626	H + 64	H + 813	H + 32	MTV-3630
		914	36	H + 1930	H + 76	H + 965	H + 38	MTV-3636

Codificación

MTV	- WW	RR	- **
Tipo de producto	Ancho	Radio de curvatura	Características especiales
	04	08	(vacío) Peralte 3¼" (83 mm)
	06	12	P4 Peralte 4" (102 mm)
	09	24	P4.5 Peralte 4.5" (114 mm)
	12	30	P5 Peralte 5" (127 mm)
	16	36	P6 Peralte 6" (152 mm)
	18		E Calibre 16 (Aplica sólo para peralte 3¼")
	20		
	24		
	30		
	36		

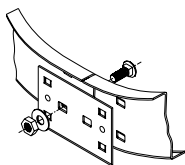

Incluye dos conectores rectos y la tornillería requerida para su unión.

H = Peralte



DERIVACIÓN A 45°

ANCHO (W)		A		Código	
mm	pul	mm	pul	Lado der.	Lado izq.
102	4	474	18 2/3	MD-04	MD-04-I
152	6	546	21 1/2	MD-06	MD-06-I
229	9	653	25 5/7	MD-09	MD-09-I
305	12	761	30	MD-12	MD-12-I
406	16	905	35 5/8	MD-16	MD-16-I
457	18	977	38 1/2	MD-18	MD-18-I
508	20	1048	41 1/4	MD-20	MD-20-I
610	24	1192	47	MD-24	MD-24-I
762	30	1408	55 3/7	MD-30	MD-30-I
914	36	1623	63 8/9	MD-36	MD-36-I

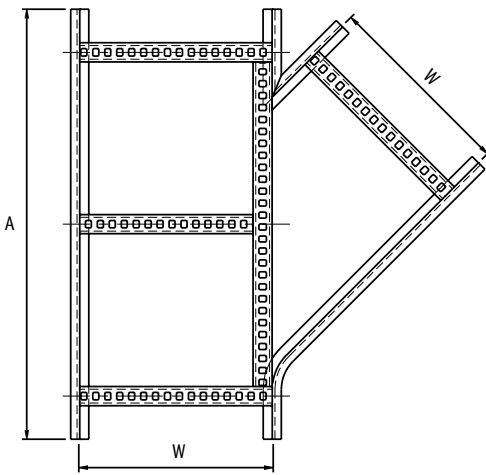

Codificación

MD	- WW	- *	- **
Tipo de producto	Ancho Centro	Lado de derivación	Características especiales
04		I	(vacío) Peralte 3¼" (83 mm)
06			P4 Peralte 4" (102 mm)
09			P4.5 Peralte 4.5" (114 mm)
12			P5 Peralte 5" (127 mm)
16			P6 Peralte 6" (152 mm)
18		E	Calibre 16 (Aplica sólo para peralte 3¼")
20			
24			
30			
36			

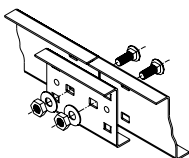

Producto calibre 16 (NEMA 8A) incluye dos conectores **rápidos** tipo "Z" y la tornillería requerida para su unión.
 Productos con otros calibres y/o peraltes incluyen dos conectores tradicionales tipo "Z" y la tornillería correspondiente.

TRAMO RECTO DE FONDO SÓLIDO Y PEFORADO

Longitud 3.66 mts. (12')



Fondo sólido



Fondo sólido perforado

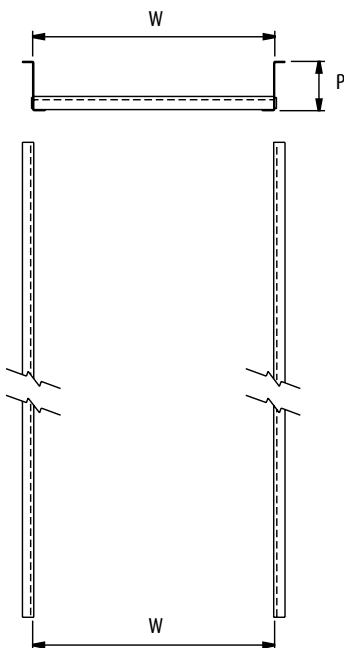

TRAMO RECTO DE CHAROLA DE FONDO SÓLIDO Y FONDO SÓLIDO PERFORADO

ANCHO (W)		Código	
mm	pul	Fondo sólido	Fondo sólido perforado
102	4	MTR-04-FS	MTR-04-FSP
152	6	MTR-06-FS	MTR-06-FSP
229	9	MTR-09-FS	MTR-09-FSP
305	12	MTR-12-FS	MTR-12-FSP
406	16	MTR-16-FS	MTR-16-FSP
457	18	MTR-18-FS	MTR-18-FSP
508	20	MTR-20-FS	MTR-20-FSP
610	24	MTR-24-FS	MTR-24-FSP
762	30	MTR-30-FS	MTR-30-FSP
914	36	MTR-36-FS	MTR-36-FSP

Codificación

MTR	WW	**	**
Tipo de producto	Ancho	Tipo de charola	Características especiales
04	FS	Fondo sólido	(vacío) Peralte 3¼" (83 mm)
06	FSP	Fondo sólido perforado	P4 Peralte 4" (102 mm)
09			P4.5 Peralte 4.5" (114 mm)
12			P5 Peralte 5" (127 mm)
16			P6 Peralte 6" (152 mm)
18			E Calibre 16 (Aplica sólo para peralte 3¼")
20			
24			
30			
36			

La terminación "E" no aplica para charola de fondo sólido perforado.

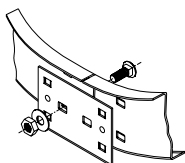

Incluye dos conectores rectos y la tornillería requerida para su unión. Cumplimiento de las normas NMX-J-511-ANCE-1999 y CFE 57000-59.

ACCESORIOS DE CHAROLA DE FONDO SÓLIDO Y FONDO SÓLIDO PERFORADO

FONDO SÓLIDO

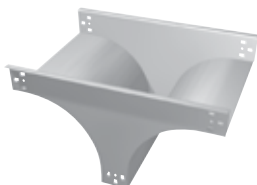
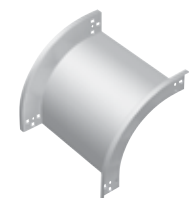
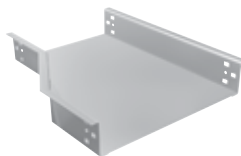
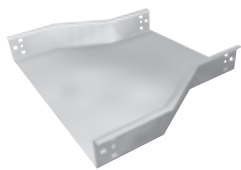
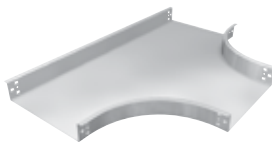

FONDO SÓLIDO PERFORADO

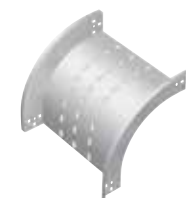

CURVA HORIZONTAL DE 45° Y 90°

Ejemplo	Código
Fondo sólido	MCH-0412-45-FS
Fondo sólido perforado	MCH-0412-45-FSP

"X" HORIZONTAL

Ejemplo	Código
Fondo sólido	MXH-1212-8-FS
Fondo sólido perforado	MXH-1212-8-FSP

"T" HORIZONTAL

Ejemplo	Código
Fondo sólido	MTH-1212-8-FS
Fondo sólido perforado	MTH-1212-8-FSP

REDUCCIÓN RECTA

Ejemplo	Código
Fondo sólido	MRR-3630-FS
Fondo sólido perforado	MRR-3630-FSP

REDUCCIONES LATERALES

Ejemplo	Código
Fondo sólido	MRL-3630-D-FS
Fondo sólido perforado	MRL-3630-D-FSP

CURVA VERTICAL EXTERIOR A 45° Y 90°

Ejemplo	Código
Fondo sólido	MVE-0408-45-FS
Fondo sólido perforado	MVE-0408-45-FSP

"T" VERTICAL

Ejemplo	Código
Fondo sólido	MTV-0908-FS
Fondo sólido perforado	MTV-0908-FSP

NOTAS: Agregar -FS al final del código del accesorio para obtener el código con Fondo Sólido.
 Agregar -FSP al final del código del accesorio para obtener el código con Fondo Sólido Perforado.

TAPAS PARA TRAMO RECTO

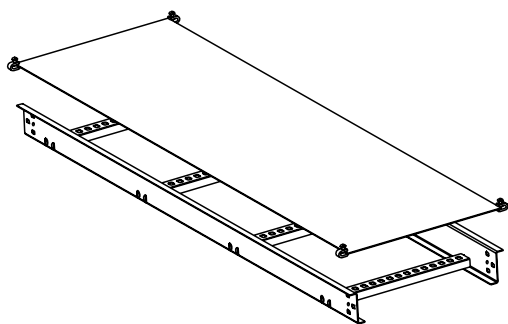

Ej. MTR-06-TLS

TAPA PLANA PARA TRAMO RECTO

Material	Aluminio
Formato	Tapa plana
Longitud	1220 mm (48")
Empaque	3 piezas
Calibre	20

Codificación

MTR	- WW	- TLS
Tipo de producto	Ancho	Tapa plana
	04	
	06	
	09	
	12	
	16	
	18	
	20	
	24	
	30	
	36	

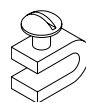

Incluye los clips de sujeción.

TAPA DOS AGUAS PARA TRAMO RECTO

Material	Aluminio
Formato	Tapa 2 aguas
Longitud	1220 mm (48")
Empaque	3 piezas
Calibre	20

Codificación

MTR	- WW	- 2A
Tipo de producto	Ancho	Tapa 2 aguas
	04	
	06	
	09	
	12	
	16	
	18	
	20	
	24	
	30	
	36	

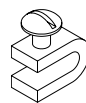

Incluye los clips de sujeción.

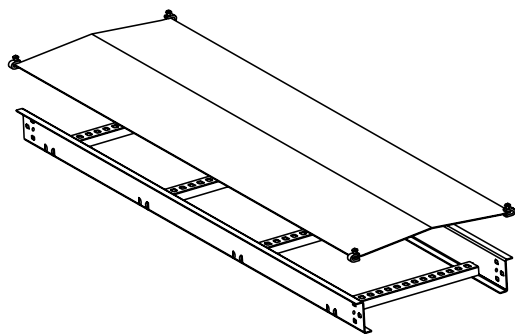

Ej. MTR-06-2A

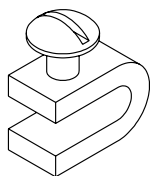

CLIP DE SUJECIÓN PARA TAPAS

Código

KIT-MCT-04

Incluye 4 clips.

TAPAS PARA ACCESORIOS

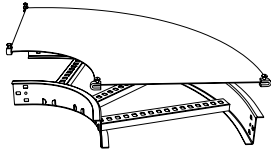

CURVA HORIZONTAL DE 45° Y 90°

Ejemplo

MCH-0412-45-TS

MCH-0412-90-TS

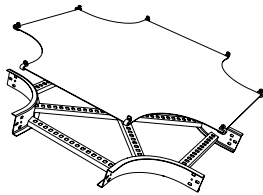

"X" HORIZONTAL

Ejemplo

MXH-1212-8-TS

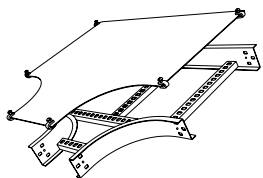

"T" HORIZONTAL

Ejemplo

MTH-1212-8-TS

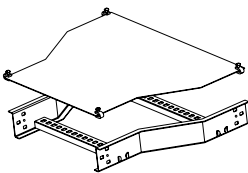

REDUCCIÓN RECTA

Ejemplo

MRR-3630-TS

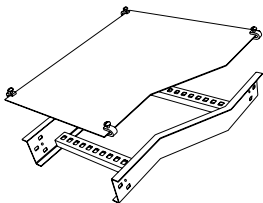

REDUCCIONES LATERALES

Ejemplo

MRL-3630-TS

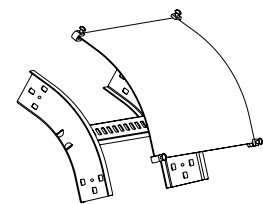

CURVA VERTICAL EXTERIOR A 45° Y 90°

Ejemplo

MVE-0408-45-TS

MVE-0408-90-TS

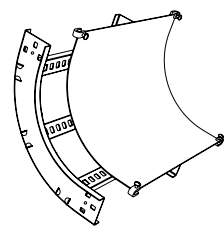

CURVA VERTICAL INTERIOR A 45° Y 90°

Ejemplo

MVI-0408-45-TS

MVI-0408-90-TS

NOTAS: Las tapas para todos los accesorios son lisas.
 Agregar -TS al final del código del accesorio para obtener el código de las tapas.

ACCESORIOS DE COMPLEMENTO

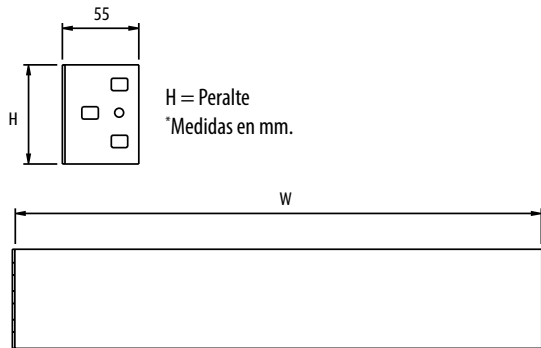

PLACA CIERRE O TERMINAL

Ancho (W)		Código
mm	pul	
102	4	MPC-04
152	6	MPC-06
229	9	MPC-09
305	12	MPC-12
406	16	MPC-16
457	18	MPC-18
508	20	MPC-20
610	24	MPC-24
762	30	MPC-30
914	36	MPC-36

Codificación		
MPC	- W W	- **
Tipo de producto	Ancho	Características especiales
	04	(vacío) Peralte 3/4" (83 mm)
	06	P4 Peralte 4" (102 mm)
	09	P5 Peralte 5" (127 mm)
	12	P6 Peralte 6" (152 mm)
	16	E Calibre 16 (Aplica sólo para peralte 3/4")
	18	
	20	
	24	
	30	
	36	

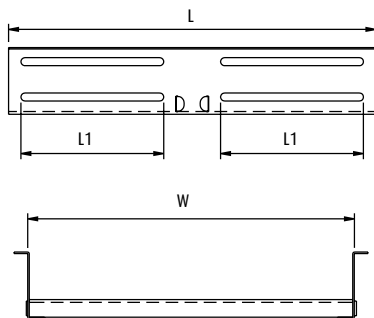
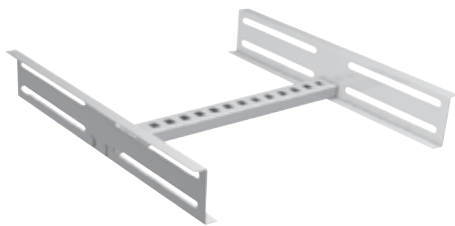

JUNTA DE EXPANSIÓN

Largo (L)		Largo 1 (L1)		Ancho (W)		Código
mm	pul	mm	pul	mm	pul	
				101.6	4	MJE-04
				152.4	6	MJE-06
				228.6	9	MJE-09
				304.8	12	MJE-12
180		70		406.4	16	MJE-16
				457.2	18	MJE-18
				508	20	MJE-20
				609.6	24	MJE-24
				762	30	MJE-30
				914.4	36	MJE-36

Codificación		
MJE	- WW	- **
Tipo de producto	Ancho	Características especiales
	04	(vacío) Peralte 3/4" (83 mm)
	06	P4 Peralte 4" (102 mm)
	09	P5 Peralte 5" (127 mm)
	12	P6 Peralte 6" (152 mm)
	16	E Calibre 16 (Aplica sólo para peralte 3/4")
	18	
	20	
	24	
	30	
	36	

MÉNSULA PARA MONTAJE EN PARED

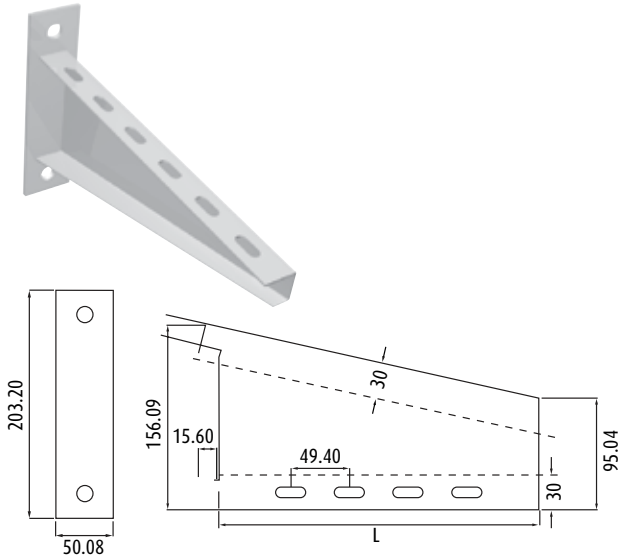

*Medidas en mm.

Ancho (W)		Longitud (L)		Código
mm	pul	mm	pul	
102	4	155	6 1/9	MMP-04
152	6	204	8	MMP-06
229	9	270	10 5/8	MMP-09
305	12	350	13 7/9	MMP-12
406	16	451	17 3/4	MMP-16
457	18	501	19 5/7	MMP-18
508	20	550	21 2/3	MMP-20
610	24	649	25 5/9	MMP-24
762	30	805	31 2/3	MMP-30
914	36	955	37 3/5	MMP-36

CLEMA PARA CHAROLA

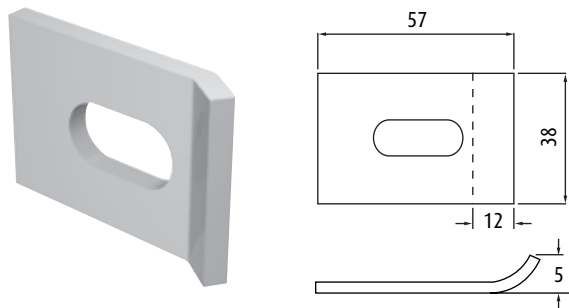

*Medidas en mm.

Ranura		Código
mm	pul	
10 x 25	3/8 x 1	MC-01
127 X 25	1/2 x 1	MC-02

BAJADA PARA CABLE

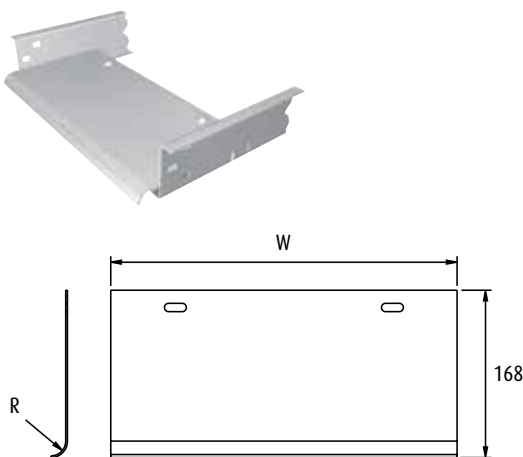

*Medidas en mm.

Ancho (W)		Código	
mm	pul	R=19 mm	R=127 mm
102	4	MBC-04-1	MBC-04-12
152	6	MBC-06-1	MBC-06-12
229	9	MBC-09-1	MBC-09-12
305	12	MBC-12-1	MBC-12-12
406	16	MBC-16-1	MBC-16-12
457	18	MBC-18-1	MBC-18-12
508	20	MBC-20-1	MBC-20-12
610	24	MBC-24-1	MBC-24-12
762	30	MBC-30-1	MBC-30-12
914	36	MBC-36-1	MBC-36-12

ACCESORIOS DE COMPLEMENTO

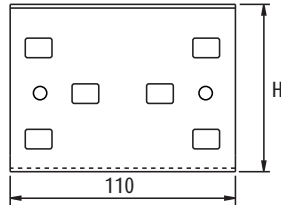

Código: MCZ-N-01CT

H = Peralte
*Medidas en mm.

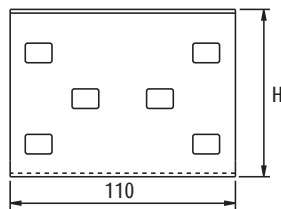

Código: MCZ-01CT

H = Peralte
*Medidas en mm.

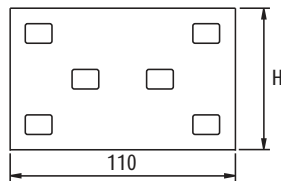

Código: MCR-01CT

H = Peralte
*Medidas en mm.

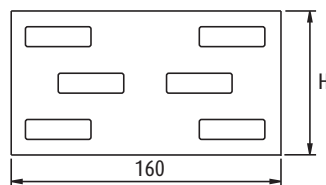
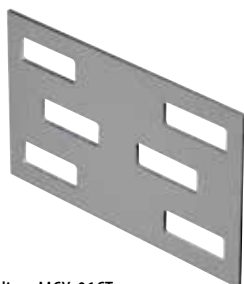

Código: MCX-01CT

H = Peralte
*Medidas en mm.



Código: MEA-01

CONECTOR RÁPIDO "Z"

Codificación

MCZ-N-01CT

Sólo para charola peralte 3 1/4", clasificación 8A

CONECTOR "Z"

Codificación

MCZ-01CT

..**

Tipo de producto

Características especiales

E	Peralte 3 1/4" (83 mm)
P4	Peralte 4" (102 mm)
P5	Peralte 5" (127 mm)
P6	Peralte 6" (152 mm)

CONECTOR RECTO

Codificación

MCR-01CT

..**

Tipo de producto

Características especiales

P4	Peralte 4" (102 mm)
P5	Peralte 5" (127 mm)
P6	Peralte 6" (152 mm)

CONECTOR DE EXPANSIÓN

Codificación

MCX-01CT

..**

Tipo de producto

Características especiales

E	Peralte 3 1/4" (83 mm) Calibre 16
P4	Peralte 4" (102 mm)
P5	Peralte 5" (127 mm)
P6	Peralte 6" (152 mm)
	Peralte 3 1/4" (83 mm) Calibre 14

ELEVADOR AJUSTABLE

Codificación

MEA-01

..**

Tipo de producto

Características especiales

E	Peralte 3 1/4" (83 mm) Calibre 16
P4	Peralte 4" (102 mm)
P5	Peralte 5" (127 mm)
P6	Peralte 6" (152 mm)
	Peralte 3 1/4" (83 mm) Calibre 14



CLIP "U"

Diámetro de ranura		Código
mm	pul	
10	3/8	MCU-01
13	1/2	MCU-02

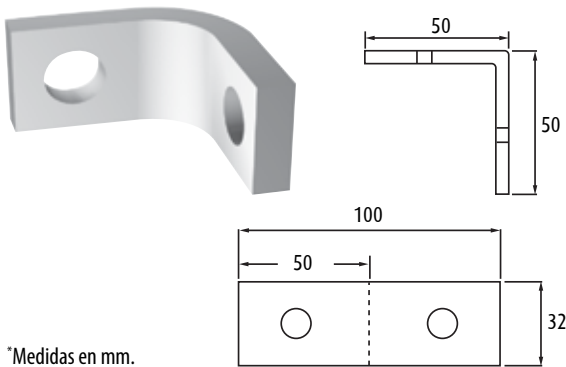

*Medidas en mm.

CLIP ANGULAR SENCILLO A 90°

Código _____
MCA-S _____

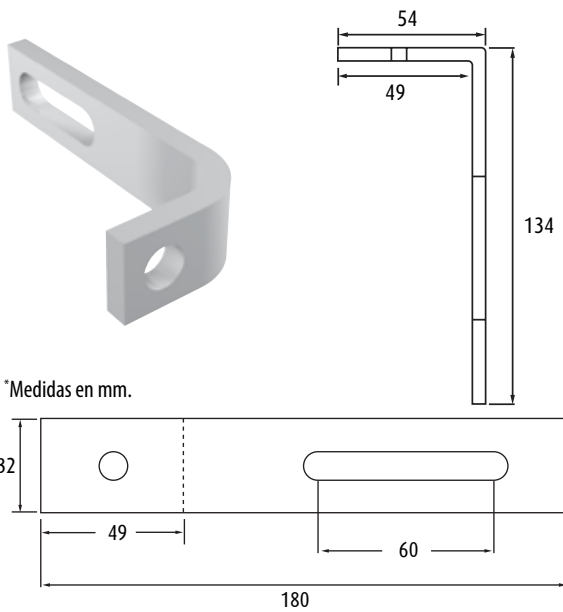

*Medidas en mm.

CLIP ANGULAR AJUSTABLE A 90°

Código _____
MCA-A _____

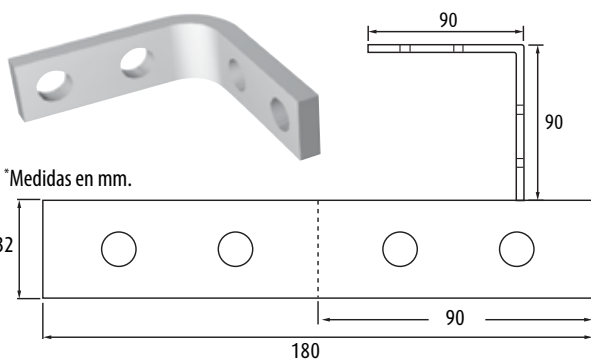

*Medidas en mm.

CLIP ANGULAR DOBLE A 90°

Código _____
MCA-D _____

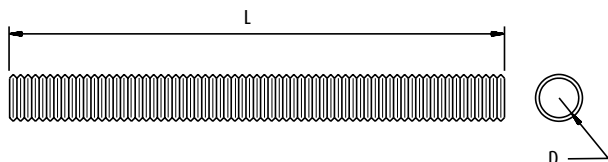

VARILLA ROSCADA

Diámetro de varilla (D)		Longitud (L)		Código
mm	pul	mm	pul	
13	1/2	1000	39 3/8	MVR- 1/2-1
6	1/4			MVR- 1/4-1
10	3/8			MVR- 3/8-1
13	1/2	3000	118 1/8	MVR- 1/2-3
6	1/4			MVR- 1/4-3
10	3/8			MVR- 3/8-3

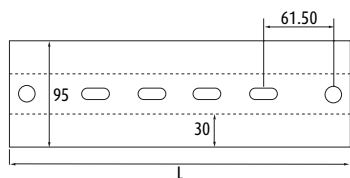

*Medidas en mm.

CANAL HORIZONTAL

Ancho (W)		Distancia (L)		Código
mm	pul	mm	pul	
102	4	203	8	MCS-04-01
152	6	245	9 2/3	MCS-06-01
229	9	316	12 4/9	MCS-09-01
305	12	400	15 3/4	MCS-12-01
406	16	499	19 2/3	MCS-16-01
457	18	549	21 3/5	MCS-18-01
508	20	598	23 1/2	MCS-20-01
610	24	700	27 5/9	MCS-24-01
762	30	852	33 1/2	MCS-30-01
914	36	1003	39 1/2	MCS-36-01



*Medidas en mm.

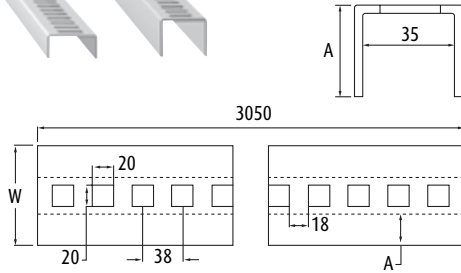

CANAL VERTICAL

Longitud (L)		Altura (A)		Canal	Código
mm	pul	mm	pul		
3050	120	18	5/7	POCO PROFUNDO	MCV-01
3050	120	30	1 1/6	PROFUNDO	MCV-02



*Medidas en mm.

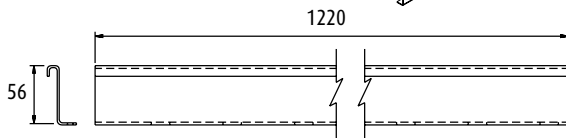
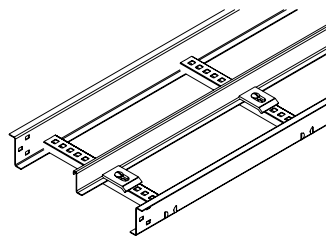

SEPARADOR PARA TRAMO RECTO

Código

MTR-S-122

Para peraltes 4", 5" y 6" agregar P4, P5 y P6 respectivamente al final de cada código.



H = Peralte
*Medidas en mm.

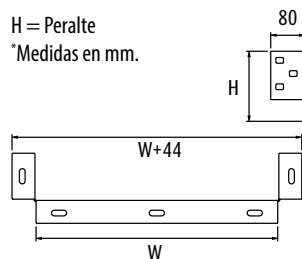

Incluye tornillos.

CONECTOR DE ESCALERA A CAJA

Ancho charola (W)		Código
mm	pul	
102	4	MCE-04
152	6	MCE-06
229	9	MCE-09
305	12	MCE-12
406	16	MCE-16
457	18	MCE-18
508	20	MCE-20
610	24	MCE-24
762	30	MCE-30
914	36	MCE-36

INSTALACIÓN DE CHAROLA DE ALUMINIO

MONTAJE GENERAL

- 1 Clip "U"
- 2 Varilla roscada
- 3 Tramo recto de charola
- 4 Clema para charola
- 5 Clema horizontal
- 6 Conector "Z"
- 7 Separador

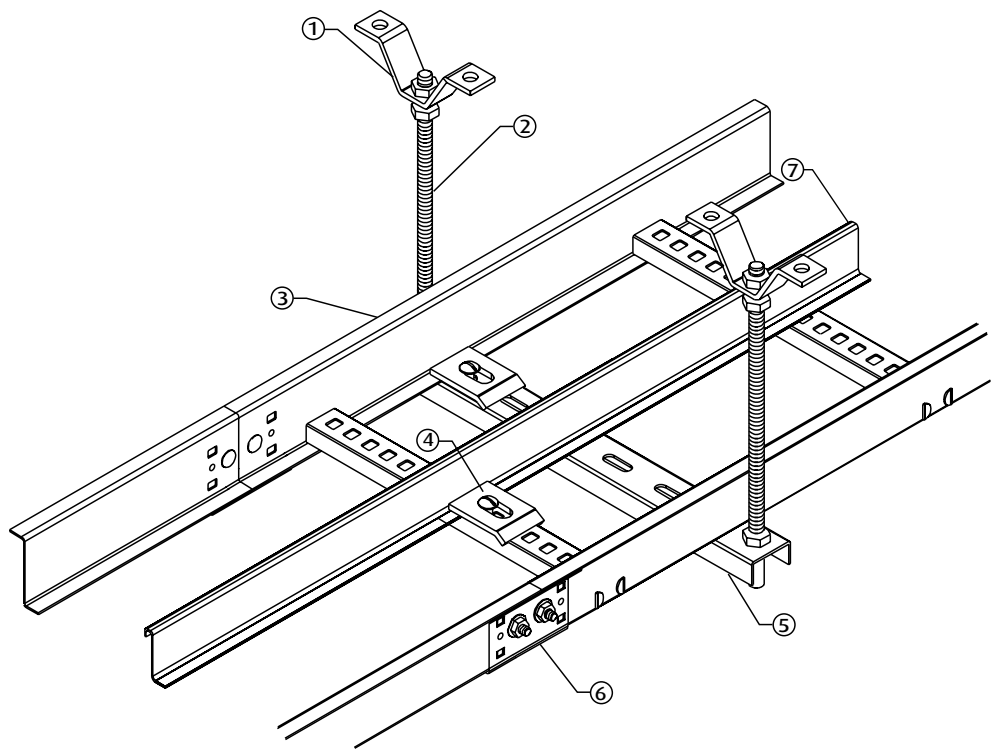

INSTALACIÓN DE "T" O "X" HORIZONTAL CON REDUCCIÓN EN ALGUNO DE LOS EXTREMOS

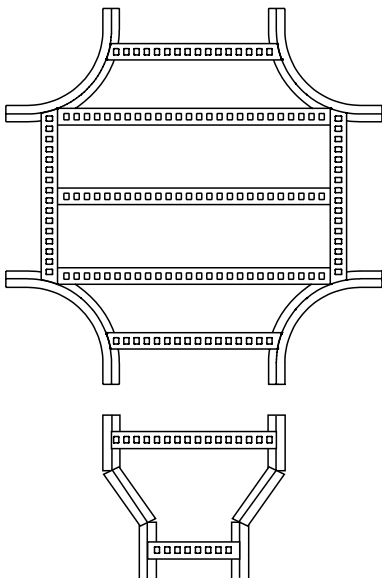

Se debe instalar el accesorio "T" o "X" más un accesorio reductor recto.

INSTALACIÓN DE "T" O "X" HORIZONTAL CON AMPLIACIÓN EN ALGUNO DE LOS EXTREMOS

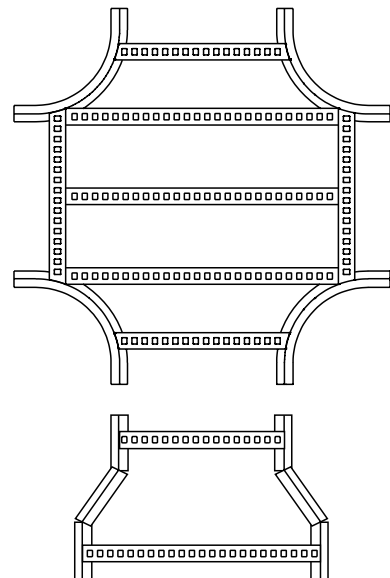

Se debe instalar el accesorio "T" o "X" más un accesorio reductor recto.



Índice

110-115		
Ducto cuadrado	Características generales	110
	Tramos	112
	Accesorios	112
	Unicanal	115

DUCTO CUADRADO

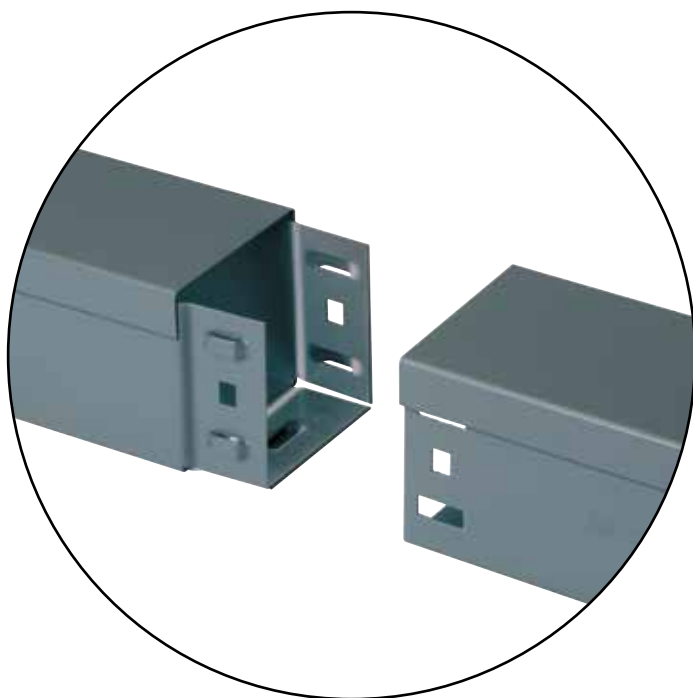

Conector rápido



El sistema de soporte cerrado tipo ducto cuadrado sirve para proteger los grupos de conductores eléctricos de agentes químicos, objetos que los puedan golpear, animales o intrusión no deseada; además, permite fácil acceso y organización.

Estas canalizaciones no deben ser instaladas en lugares clasificados como peligrosos según la Norma Oficial Mexicana.

El sistema de ducto cuadrado se fabrica con acero de lámina negra con un recubrimiento de pintura epoxipoliéster horneada en colores gris claro o blanco, la cual brinda una alta resistencia a la corrosión. Disponible en versiones de calibre 20 y 22.

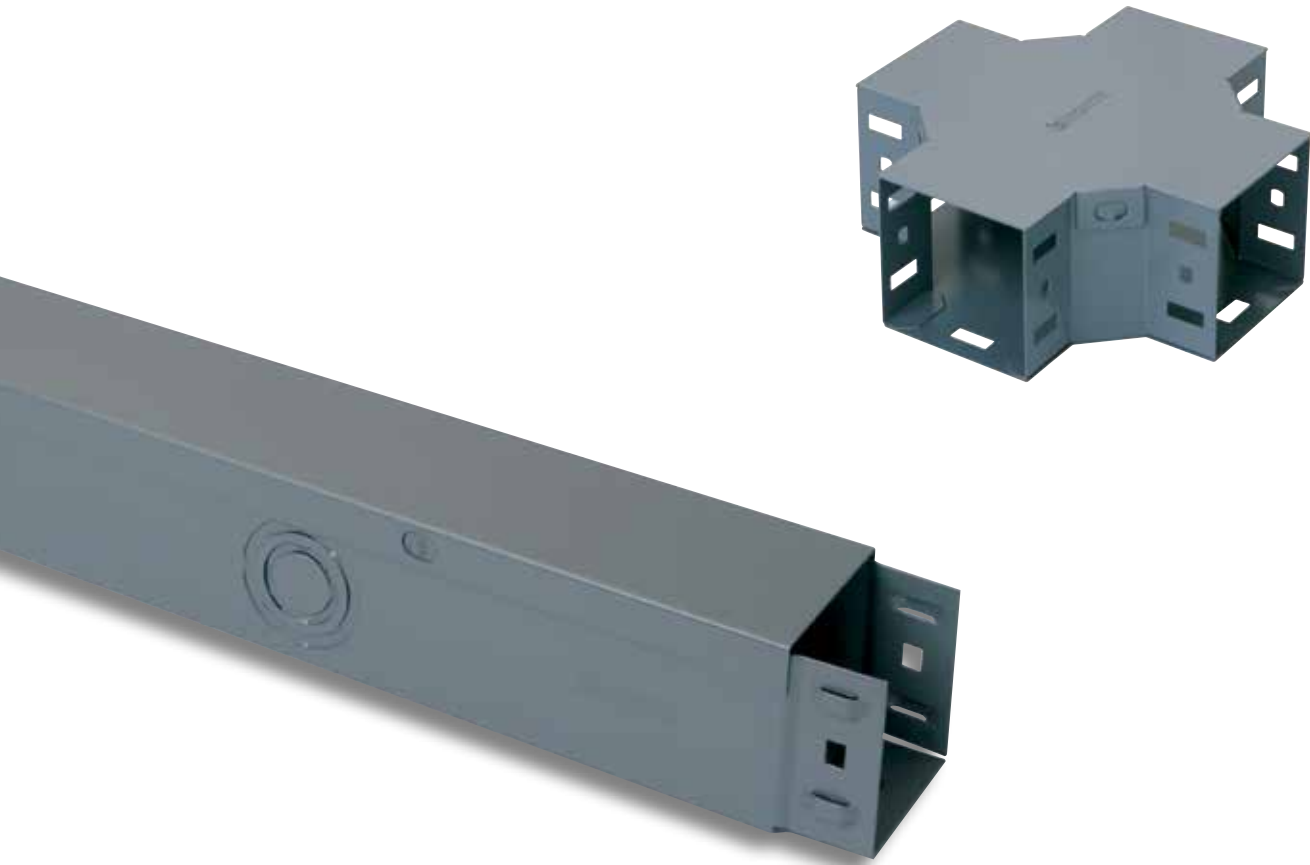

ESPECIFICACIONES DEL DUCTO

Características	Descripciones
Material	Acero negro fosfatizado
Pintura	Polvo epoxipoliéster horneado que brinda alta resistencia a la corrosión.
Calibre estándar	20
Calibre ligero	22
Color:	Gris claro o blanco

APLICACIONES

El ducto cuadrado puede ser instalado en una variedad de aplicaciones, como puede ser para almacenar circuitos de alumbrado, cableado de un tablero de distribución, así como para protección de otras tuberías, siendo en la mayoría de los casos una instalación más rápida y económica que la instalación de tubería conduit.

TRAMOS Y ACCESORIOS

Longitud del tramo 1.49 mts (4' 10 2/3")



Incluye conector y tornillería.

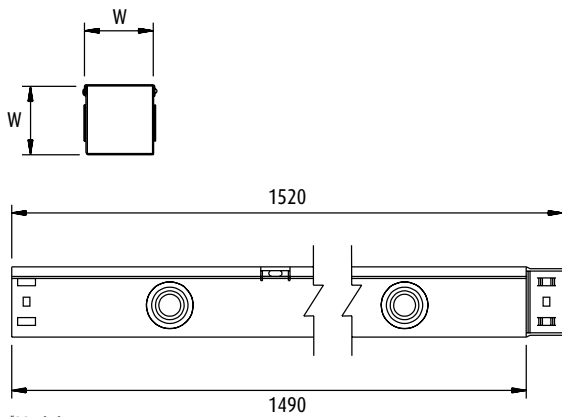

*Medidas en mm.

TRAMOS RECTOS

Ancho (W)	Código		Color
	mm	pul	
65 x 65	2 1/2 x 2 1/2	DTR-065N DTR-065-EN	GRIS
100 x 100	4 x 4	DTR-100N DTR-100-EN	
150 x 150	6 x 6	DTR-150N DTR-150-EN	
65 x 65	2 1/2 x 2 1/2	DTR-065-BN DTR-065-EBN	BLANCO
100 x 100	4 x 4	DTR-100-BN DTR-100-EBN	
150 x 150	6 x 6	DTR-150-BN DTR-150-EBN	

CODO A 90°

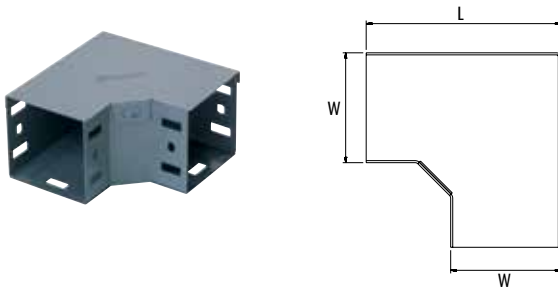

Ancho (W)	Largo (L)	Código		Color	
		mm	pul		
65 x 65	2 1/2 x 2 1/2	115	4 1/2	DC-065-90N	GRIS
100 x 100	4 x 4	150	6	DC-100-90N	
150 x 150	6 x 6	200	7 4/5	DC-150-90N	
65 x 65	2 1/2 x 2 1/2	115	4 1/2	DC-065-90-BN	BLANCO
100 x 100	4 x 4	150	6	DC-100-90-BN	
150 x 150	6 x 6	200	7 4/5	DC-150-90-BN	

CODO A 45°

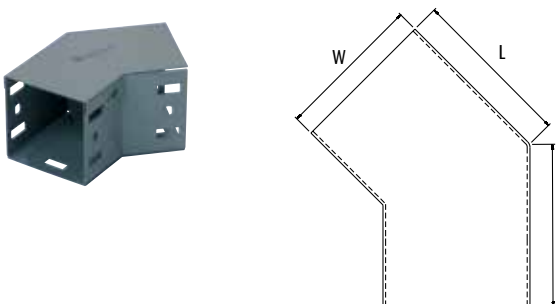

Ancho (W)	Largo (L)	Código		Color	
		mm	pul		
65 x 65	2 1/2 x 2 1/2	73	2 6/7	DC-065-45N	GRIS
100 x 100	4 x 4	87	3 3/7	DC-100-45N	
150 x 150	6 x 6	108	4 1/4	DC-150-45N	
65 x 65	2 1/2 x 2 1/2	73	2 6/7	DC-065-45-BN	BLANCO
100 x 100	4 x 4	87	3 3/7	DC-100-45-BN	
150 x 150	6 x 6	108	4 1/4	DC-150-45-BN	

ACCESORIOS

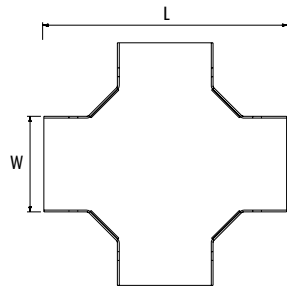

"X"

Ancho (W)		Largo (L)		Código	COLOR
mm	pul	mm	pul		
65 x 65	2 1/2 x 2 1/2	165	6 1/2	DX-065N	GRIS
100 x 100	4 x 4	200	7 7/8	DX-100N	
150 x 150	6 x 6	250	9 5/6	DX-150N	
65 x 65	2 1/2 x 2 1/2	165	6 1/2	DX-065-BN	BLANCO
100 x 100	4 x 4	200	7 7/8	DX-100-BN	
150 x 150	6 x 6	250	9 5/6	DX-150-BN	

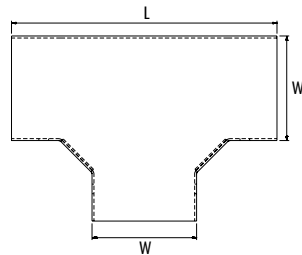

"T"

Ancho (W)		Largo (L)		Código	COLOR
mm	pul	mm	pul		
65 x 65	2 1/2 x 2 1/2	165	6 1/2	DT-065N	GRIS
100 x 100	4 x 4	200	7 7/8	DT-100N	
150 x 150	6 x 6	250	9 5/6	DT-150N	
65 x 65	2 1/2 x 2 1/2	165	6 1/2	DT-065-BN	BLANCO
100 x 100	4 x 4	200	7 7/8	DT-100-BN	
150 x 150	6 x 6	250	9 5/6	DT-150-BN	

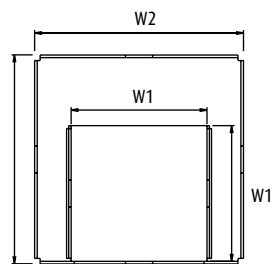

REDUCCIÓN

Ancho (W1)		Ancho (W2)		Código	COLOR
mm	pul	mm	pul		
65	2 1/2	100	4	DRE-6510N	GRIS
		150	6	DRE-6515N	
100	4	150	6	DRE-1015N	BLANCO
		100	4	DRE-6510-BN	
65	2 1/2	150	6	DRE-6515-BN	BLANCO
		100	4	DRE-1015-BN	

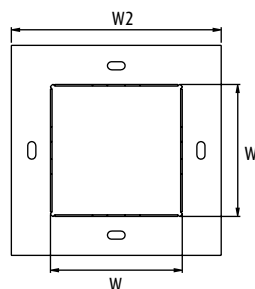
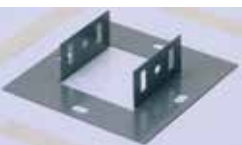

BRIDA PARA TABLERO

Ancho (W)		Ancho (W2)		Código	COLOR
mm	pul	mm	pul		
65 x 65	2 1/2 x 2 1/2	119	4 1/2	DBT-065N	GRIS
100 x 100	4 x 4	154	6	DBT-100N	
150 x 150	6 x 6	204	8	DBT-150N	
65 x 65	2 1/2 x 2 1/2	119	4 1/2	DBT-065-BN	BLANCO
100 x 100	4 x 4	154	6	DBT-100-BN	
150 x 150	6 x 6	204	8	DBT-150-BN	

ACCESORIOS

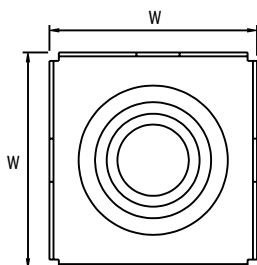

PLACA DE CIERRE

Ancho (W)		Código	Color
mm	pul		
65 x 65	2 1/2 x 2 1/2	DPC-065N	GRIS
100 x 100	4 x 4	DPC-100N	
150 x 150	6 x 6	DPC-150N	
65 x 65	2 1/2 x 2 1/2	DPC-065-BN	BLANCO
100 x 100	4 x 4	DPC-100-BN	
150 x 150	6 x 6	DPC-150-BN	

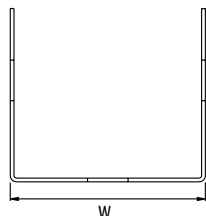

CONECTOR RÁPIDO

Ancho (W)		Código	Color
mm	pul		
65 x 65	2 1/2 x 2 1/2	DCN-065N	GRIS
100 x 100	4 x 4	DCN-100N	
150 x 150	6 x 6	DCN-150N	
65 x 65	2 1/2 x 2 1/2	DCN-065-BN	BLANCO
100 x 100	4 x 4	DCN-100-BN	
150 x 150	6 x 6	DCN-150-BN	

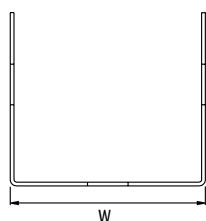

CONECTOR HÍBRIDO

Ancho (W)		Código	Color
mm	pul		
65 x 65	2 1/2 x 2 1/2	DCN-065H	GRIS
100 x 100	4 x 4	DCN-100H	
150 x 150	6 x 6	DCN-150H	
65 x 65	2 1/2 x 2 1/2	DCN-065-BH	BLANCO
100 x 100	4 x 4	DCN-100-BH	
150 x 150	6 x 6	DCN-150-BH	

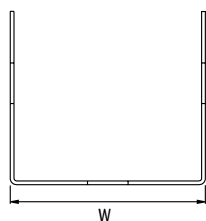

CONECTOR

Ancho (W)		Código	Color
mm	pul		
65 x 65	2 1/2 x 2 1/2	DCN-065	GRIS
100 x 100	4 x 4	DCN-100	
150 x 150	6 x 6	DCN-150	
65 x 65	2 1/2 x 2 1/2	DCN-065-B	BLANCO
100 x 100	4 x 4	DCN-100-B	
150 x 150	6 x 6	DCN-150-B	

UNICANAL



Liso

Perforado

Longitud: 3.05 mts. (3050 mm)

UNICANAL

Ancho (W)		Código		Material
mm	pul	CALIBRE	LISO	PERFORADO
40 x 20	1/2 x 3/4	14	UNF-42	UNF-42-P
40 x 40	1/2 X 1/2	14	UNF-44	UNF-44-P
40 x 20	1/2 x 3/4	16	UNF-42-16	UNF-42-16-P
40 x 40	1/2 X 1/2	16	UNF-44-16	UNF-44-16-P

ACERO

TUERCA CON RESORTE

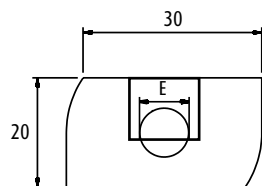

*Medidas en mm.

Espesor (E)		Código
mm	pul	
13	1/2	UTR-1/2
6	1/4	UTR-1/4
10	3/8	UTR-3/8
8	5/16	UTR-5/16

ABRAZADERA

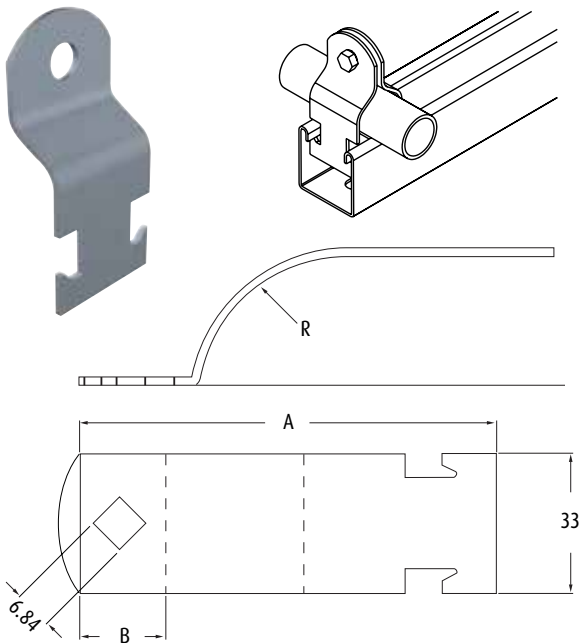

*Medidas en mm.

Radio tubo (R)		A		B		C		Código
mm	pul	mm	pul	mm	pul	mm	pul	ACERO
13	0.5	64	2 1/2	23	1	5.5	2/9	UAF-050
19	0.75	70	2 3/4	23	1	10	2/5	UAF-075
25	1	77	3	23	1	13.8	1/2	UAF-100
32	1.25	88	3 1/2	23	1	16.41	2/3	UAF-125
38	1.5	93	3 2/3	23	1	18.19	5/7	UAF-150
51	2	112	4 2/5	25	1	22.92	1	UAF-200
64	2.5	128	5	25	1	31.5	1 1/4	UAF-250
76	3	154	6	25	1	37	1 1/2	UAF-300
102	4	185	7 2/7	26	1	48	1 8/9	UAF-400
152	6	250	9 5/6	28	1 1/9	75	3	UAF-600
203	8	315	12 2/5	28	1 1/9	99	3 8/9	UAF-800
254	10	380	15	28	1 1/9	125	5	UAF-010



Índice

117-130
RTGAMMA

Características generales	117
Características constructivas	117
Catálogo	120
Catálogo condensado	128
Selección del ducto adecuado	130

DUCTO METÁLICO



■ CARACTERÍSTICAS GENERALES

RTGamma es un sistema de canalización (ductos metálicos) que ofrece una solución flexible para la conducción del cableado de circuitos alimentadores y derivados, proporcionando protección contra daño mecánico a cables o alambres. Una amplia gama de accesorios está

disponible con secciones de 75x75, 150x75 y 300x75 mm cuyo diseño permite resolver con eficacia todos los problemas de instalación facilitando cualquier trayectoria que se desee formar, lo que la hace ideal para aplicaciones en la industria, oficinas o comercios.

■ CARACTERÍSTICAS CONSTRUCTIVAS

El diseño de los ductos RTGAMMA proporciona excelentes propiedades mecánicas y funcionales que se traducen en mayor duración, flexibilidad y facilidad de instalación; adaptándose a las más estrictas exigencias del mercado.

RTGAMMA no presenta discos removibles (knockouts) lo que permite:
Evitar desprendimientos no deseados.
Realizar los barrenos del diámetro adecuado y en el lugar adecuado a la tubería conduit requerida.



MAYOR DURACIÓN

Su fabricación en acero zincado en caliente de tipo electrolítico Sendzimir y acero inoxidable 304 garantizan excelentes cualidades anticorrosivas tanto en ambientes secos como de alta humedad relativa.

Asegurar el grado de protección IP40 (protección contra la penetración de objetos sólidos).

El zincado del acero recubre las partes en donde se realizan los cortes, evitando así los efectos de la corrosión y asegurando mayor duración del ducto.

TRAMOS RECTOS

Los tramos rectos se fabrican en longitud de 2 metros * en sección rectangular con sistema de tapa a presión.

Dimensiones Generales

L	A x H
	75 x 75 mm
2.0 m *	150 x 75 mm
	300 x 75 mm

* 3m para versión inoxidable

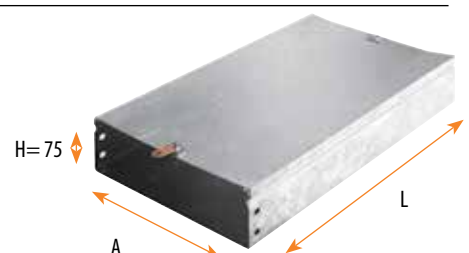

DUCTO METÁLICO

MAYOR RESISTENCIA

Los tramos rectos y accesorios RTGAMMA se unen firmemente entre sí con una placa de unión y 4 tornillos por cada lado (Conector normal) o con 2 tornillos por cada lado (Conector rápido).



Las placas de unión aseguran una excelente continuidad mecánica y eléctrica.

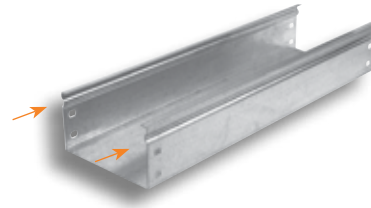
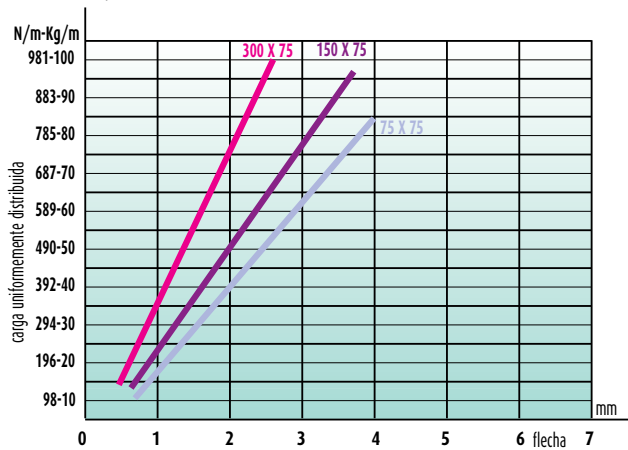

El doblez longitudinal le brinda mayor rigidez y resistencia.

DIAGRAMA DE CARGA ADMISIBLE

La gráfica ilustra la carga admisible del ducto bajo las siguientes condiciones:

Claro entre soportes: 2 metros.

Carga uniformemente distribuida.

Elemento simplemente apoyado en el soporte.

Flecha elástica máxima considerada.

Coefficiente de seguridad: 1.5

DATOS TÉCNICOS

Fabricación en acero zincado en caliente/acero inoxidable 304.

FePO2G-Z200 de acuerdo con la norma

UNI EN 10142.

Grado de Protección IP40.

CARACTERÍSTICAS CONSTRUCTIVAS

Sistema de tapa a presión

A diferencia de los ductos tradicionales (tapa con bisagra), RTGAMMA cuenta con cierre de tapa a presión.

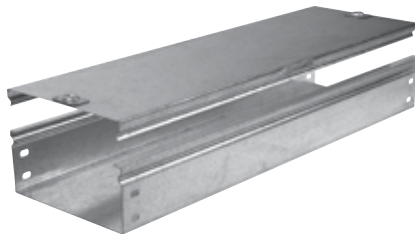

El sistema de tapa a presión permite:

Fácil y rápido acceso durante labores de mantenimiento.

Retirando la tapa es posible utilizarlo como bandeja o charola con piso.

DISPOSICIÓN RECTANGULAR

La sección geométrica transversal de RTGAMMA es rectangular, con una altura fija de 75 mm y en tres medidas de ancho 75, 150, 300 mm.

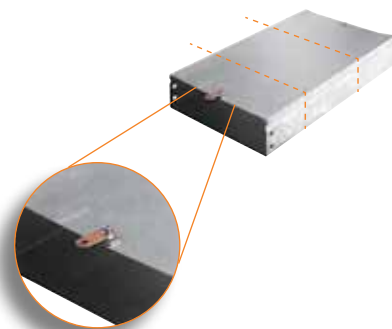

La tapa siempre garantiza un cierre uniforme en cualquier punto de la trayectoria.

El conector de cobre asegura la continuidad eléctrica en las tapas.

ACCESORIOS

En todos los accesorios es posible retirar las tapas para tener un rápido acceso al cableado en cualquier

parte de la trayectoria. Los contornos circulares reducen el riesgo de daños en el aislamiento de los conductores y

facilitan el tendido de los mismos.

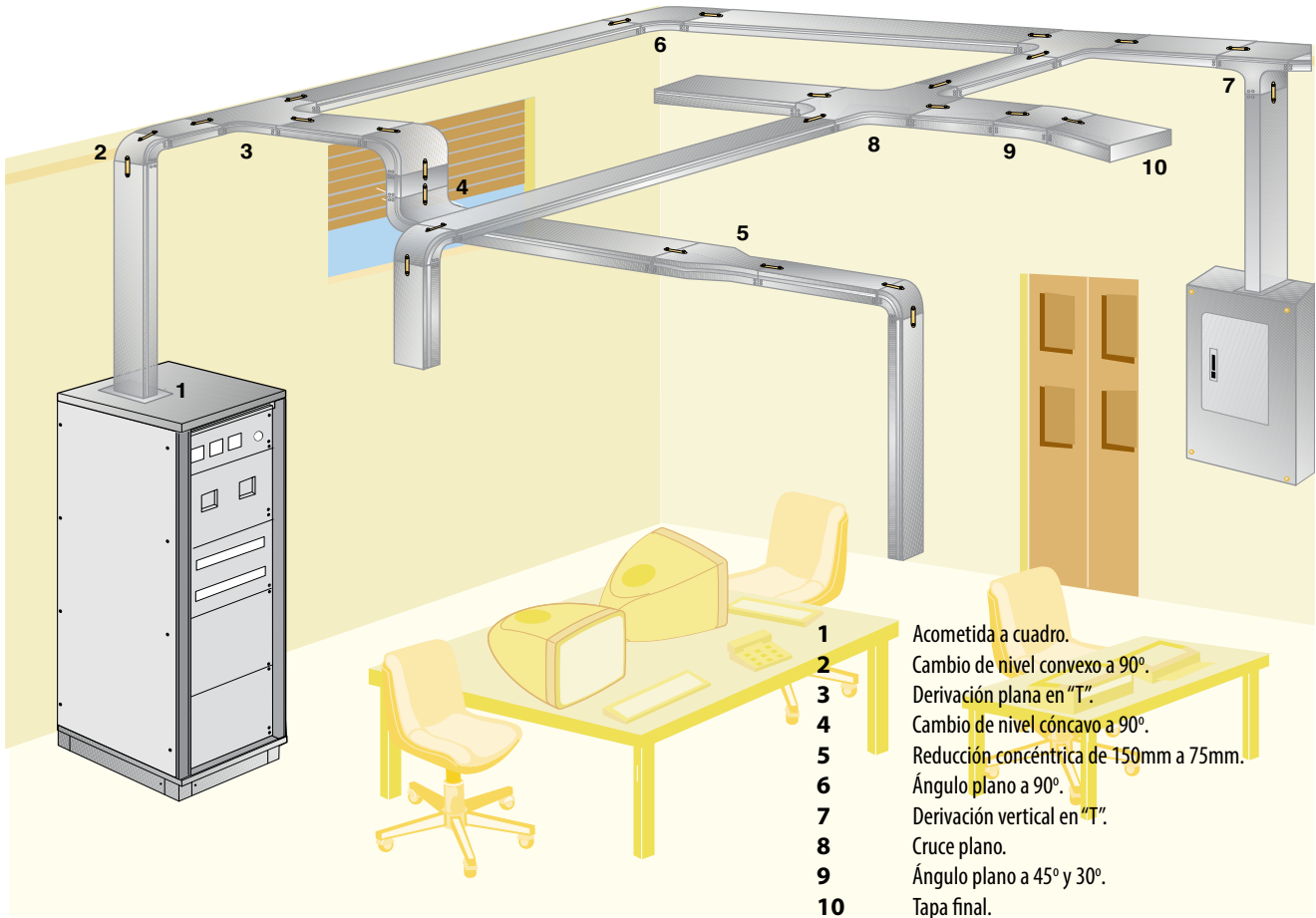

El empleo del ducto permite realizar las instalaciones más rápido y a menor costo comparado con el uso de tubo conduit, ya que no requiere herramientas costosas, es ligero y las modificaciones al cableado se realizan fácilmente al igual que las labores de mantenimiento.

NORMATIVA

RTGamma está certificado en plena conformidad con las normas internacionales IEC.

EQNET (Organismo Internacional para el aseguramiento de Calidad y Certificación) en conformidad con los estándares ISO 9000.

CISQ (Certificación del Sistema de Calidad de Empresas) en Italia, en conformidad con la norma UNI en ISO 9002, haciendo referencia al diseño y comercialización de sistemas.



CATÁLOGO

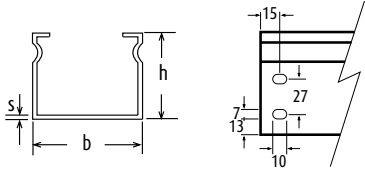
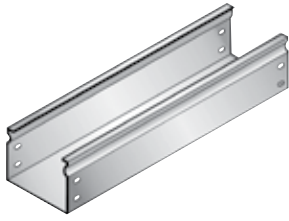

TRAMOS RECTOS DE 2 METROS

(mm)	b (mm)	h (mm)	ℓ (mm)	s (mm)	Kg/m	EZ	304
75x75	75	75	EZ=2000 304=3000	0.8 (cal.20)	1.58	31C2C075Z	31C3C075X
75x150	150	75	EZ=2000 304=3000	0.8 (cal.20)	2.03	31C2C150Z	31C3C150X
75x300	300	75	EZ=2000 304=3000	1.2 (cal.18)	4.27	31C2C300Z	31C3C300X

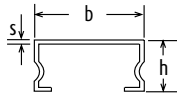
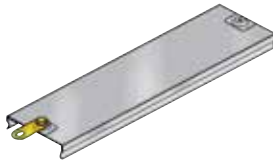

TAPAS PARA TRAMOS RECTOS DE 2 METROS

(mm)	b (mm)	h (mm)	ℓ (mm)	s (mm)	Kg/m	EZ	304
75x75	75	22	EZ=2000 304=3000	0.5 (cal.24)	0.58	31L29075Z	31L39075X
75x150	150	22	EZ=2000 304=3000	0.5 (cal.24)	0.91	31L29150Z	31L39150X
75x300	300	22	EZ=2000 304=3000	0.6 (cal.24)	1.63	31L29300Z	31L39300X

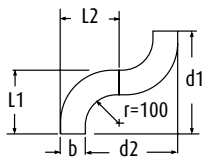

ÁNGULO PLANO A 90° (TAPA INCLUIDA)

(mm)	b (mm)	L1 (mm)	L2 (mm)	d1 (mm)	d2 (mm)	Kg	EZ	304
75x75	75	205	205	335	335	0.90	31AIC075Z	31AIC075X
75x150	150	280	280	410	410	1.52	31AIC150Z	31AIC150X
75x300	300	430	430	560	560	3.09	31AIC300Z	31AIC300X

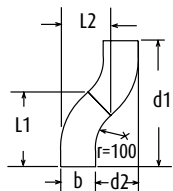
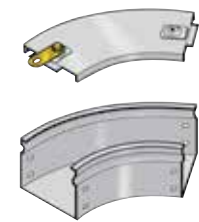

ÁNGULO PLANO A 45° (TAPA INCLUIDA)

(mm)	b (mm)	L1 (mm)	L2 (mm)	d1 (mm)	d2 (mm)	Kg	EZ	304
75x75	75	176	126	298	123	0.54	31AJC075Z	31AJC075X
75x150	150	229	201	351	146	0.90	31AJC150Z	31AJC150X
75x300	300	334	351	456	190	1.80	31AJC300Z	31AJC300X

ÁNGULO PLANO A 30° (TAPA INCLUIDA)

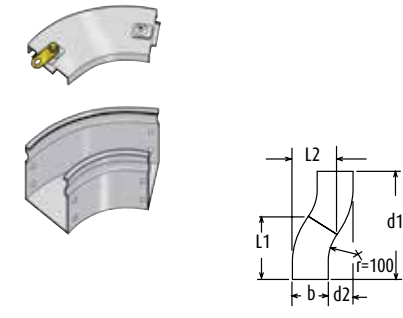

(mm)	b (mm)	L1 (mm)	L2 (mm)	d1 (mm)	d2 (mm)	Kg	EZ	304
75x75	75	144	103	250	67	0.41	31ALC075Z	-
75x150	150	181	178	288	77	0.70	31ALC150Z	-
75x300	300	256	328	363	87	1.35	31ALC300Z	-

DERIVACIÓN PLANA EN "X" (TAPA INCLUIDA)

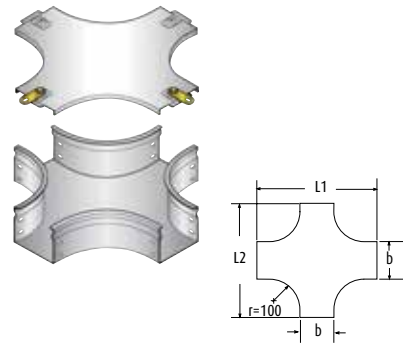

(mm)	b (mm)	L1 (mm)	L2 (mm)	Kg	EZ	304
75x75	75	335	335	1.77	31ATC075Z	31ATC075X
75x150	150	410	410	2.7	31ATC150Z	31ATC150X
75x300	300	560	560	5.18	31ATC300Z	31ATC300X

DERIVACIÓN PLANA EN "T" (TAPA INCLUIDA)

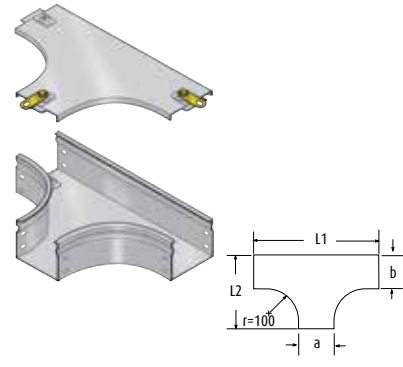

(mm)	b (mm)	L1 (mm)	L2 (mm)	Kg	EZ	304
75x75	75	335	205	1.44	31ASC075Z	31ASC075X
75x150	150	410	280	2.29	31ASC150Z	31ASC150X
75x300	300	560	430	4.28	31ASC300Z	31ASC300X

EXTENSIÓN PARA TRAMOS RECTOS (TAPA INCLUIDA)

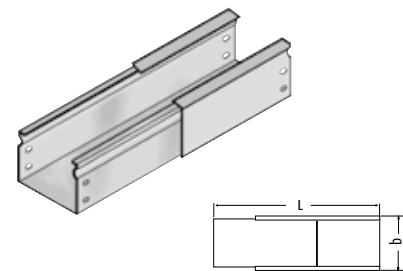

(mm)	b (mm)	L1 (mm)	Kg	EZ	304
75x75	75	220-380	0.80	31X9CT71Z	-
75x150	150	220-380	1.05	31X9CT73Z	-
75x300	300	220-380	1.72	31X9CT75Z	-

REDUCCIÓN CONCÉNTRICA (TAPA INCLUIDA)

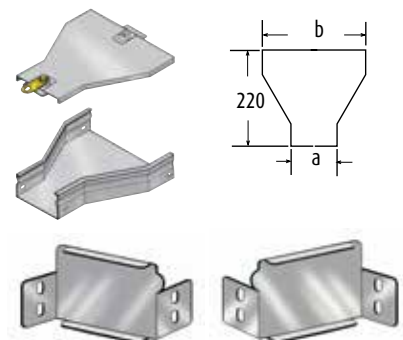

Reducción (mm)	b (mm)	a (mm)	L (mm)	Kg	EZ	304
75	150	75	220	0.88	31AHC33Z	-
150	300	150	440	1.15	31AHC375Z	-
150	-	-	-	0.19	-	31X9CD51X
150	-	-	-	0.19	-	31X9CS51X

CATÁLOGO

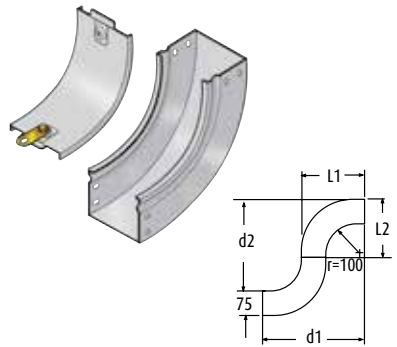

CAMBIO DE NIVEL CÓNCAVO A 90° (TAPA INCLUIDA)

(mm)	b (mm)	L1 (mm)	L2 (mm)	d1 (mm)	d2 (mm)	Kg	EZ	304
75x75	75	205	205	335	335	0.87	31AMC075Z	31AMC075X
75x150	150	205	205	335	335	1.18	31AMC150Z	31AMC150X
75x300	300	205	205	335	335	1.90	31AMC300Z	31AMC300X

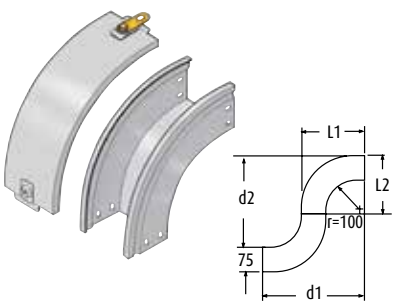

CAMBIO DE NIVEL CONVEXO A 90° (TAPA INCLUIDA)

(mm)	b (mm)	L1 (mm)	L2 (mm)	d1 (mm)	d2 (mm)	Kg	EZ	304
75x75	75	205	205	335	335	0.96	31APC075Z	31APC075X
75x150	150	205	205	335	335	1.28	31APC150Z	31APC150X
75x300	300	205	205	335	335	2.02	31APC300Z	31APC300X

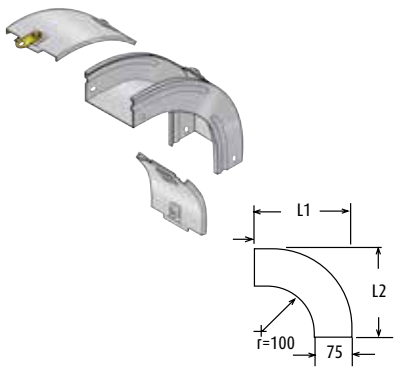

CURVA VERTICAL A 90° (TAPA INCLUIDA)

(mm)	b (mm)	h (mm)	r (mm)	L1 (mm)	L2 (mm)	Kg	EZ	304
75x75	75	75	100	205	205	0.89	31AUC075Z	-
75x150	150	75	100	205	205	1.29	31AUC150Z	-
75x300	300	75	100	205	205	1.84	31AUC300Z	-

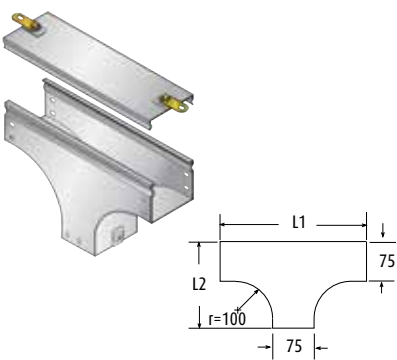

DERIVACIÓN VERTICAL EN "T" (TAPA INCLUIDA)

(mm)	b (mm)	L1 (mm)	L2 (mm)	Kg	EZ	304
75x75	75	337	207	1.39	31AWC075Z	31AWC075X
75x150	150	337	207	1.75	31AWC150Z	31AWC150X
75x300	300	337	207	2.44	31AWC300Z	31AWC300X

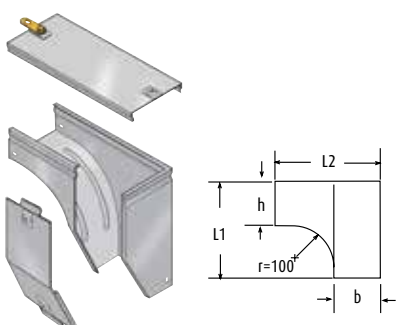

CAMBIO DE NIVEL A 90° IZQUIERDO (TAPA INCLUIDA)

(mm)	b (mm)	h (mm)	L1 (mm)	L2 (mm)	Kg	EZ	304
75x75	75	75	207	207	1.05	31AYC075Z	31AYC075X
75x150	150	75	267	280	2.10	31AYC150Z	31AYC150X
75x300	300	75	327	430	4.67	31AYC300Z	31AYC300X

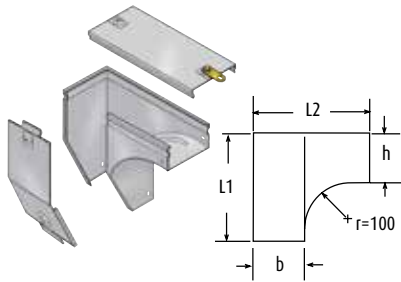

CAMBIO DE NIVEL A 90° DERECHO (TAPA INCLUIDA)

(mm)	b (mm)	h (mm)	L1 (mm)	L2 (mm)	Kg	EZ	304
75x75	75	75	207	207	1.05	31AZC075Z	31AZC075X
75x150	150	75	267	280	2.10	31AZC150Z	31AZC150X
75x300	300	75	327	430	4.67	31AZC300Z	31AZC300X

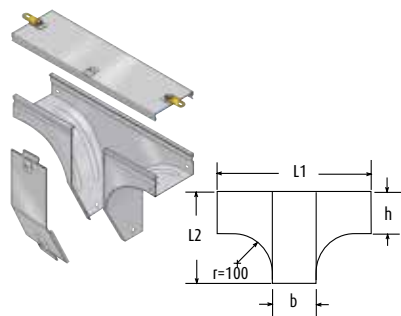

DERIVACIÓN VERTICAL EN "T" CON VARIACIÓN DE PLANO (TAPA INCLUIDA)

(mm)	b (mm)	h (mm)	L1 (mm)	L2 (mm)	Kg	EZ	304
75x75	75	75	337	207	1.39	31AXC075Z	31AXC075X
75x150	150	75	410	267	2.53	31AXC150Z	31AXC150X
75x300	300	75	560	327	5.26	31AXC300Z	31AXC300X

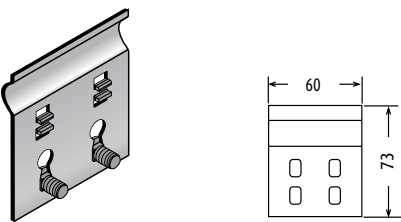

CONECTOR RÁPIDO (INCLUYE TUERCAS Y TORNILLOS)

Kg	EZ	316L
0.05	31X9CG73Z	31X9CG73L

- NOTAS:**
1. Los conectores rápidos se ordenan por separado.
 2. Para calcular la cantidad de conectores rápidos necesarios realice la siguiente operación N° de conectores = $(N^{\circ}$ de elementos a unir X 2) - 2.

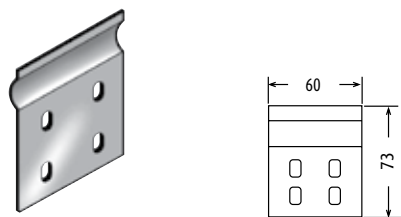

CONECTOR (INCLUYE TUERCAS Y TORNILLOS)

Kg	EZ	316L
0.07	31X9CG71Z	31X9CG71L

- NOTAS:**
1. Los conectores se ordenan por separado.
 2. Para calcular la cantidad de conectores necesarios realice la siguiente operación N° de conectores = $(N^{\circ}$ de elementos a unir X 2) - 2.

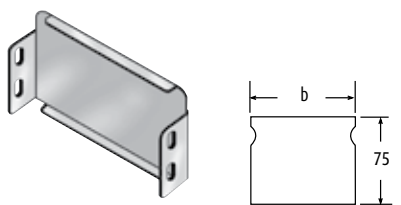

TAPA FINAL

(mm)	b (mm)	Kg	EZ	304
75x75	75	0.09	31X9CC71Z	31X9CC71X
75x150	150	0.14	31X9CC73Z	31X9CC73X
75x300	300	0.24	31X9CC75Z	31X9CC75X

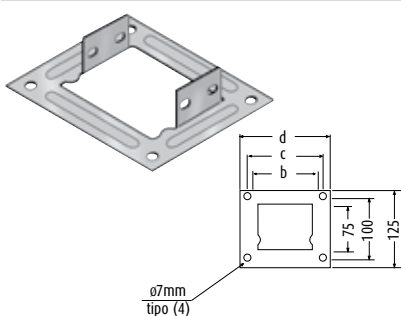

ACOMETIDA A CUADRO

(mm)	b (mm)	c (mm)	d (mm)	Kg	EZ	304
75x75	75	75	100	0.14	31X9CL71Z	-
75x150	150	75	100	0.18	31X9CL73Z	-
75x300	300	75	100	0.25	31X9CL75Z	-
75x75-400	75	-	-	0.18	-	31X9CL76X

CATÁLOGO



Ejemplo de montaje

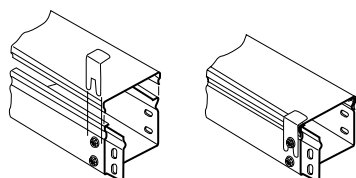

CLIP DE FIJACIÓN

Kg	EZ	316L
0.01	-	31X99Y999

NOTA: Los clips de fijación se ordenan por separado.

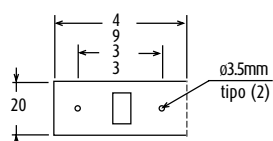
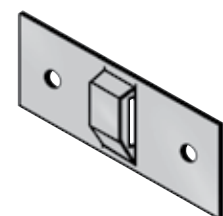

Ejemplo de montaje

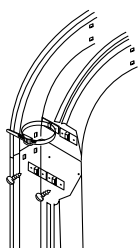
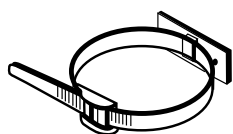

PLACA DE FIJACIÓN DE CABLES (FABRICADA EN ACERO ZINCADO)

Kg	EZ	304
0.01	31X99J99Z	-

NOTA: Cinchos no incluidos.

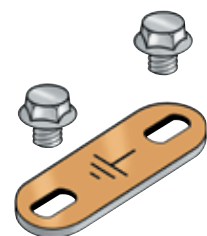

PLACA DE CONEXIÓN A TIERRA

Kg	EZ	304
0.01	31X99X999	31X99X99X

NOTA: Las placas de conexión a tierra se ordenan por separado.

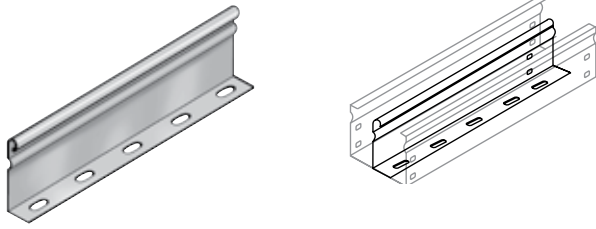

SEPARADOR PARA TRAMOS RECTOS

Altura (mm)	Longitud (mm)	Kg	EZ	304
75	EZ=2000	EZ=1.44	31X9CA73Z	31X9CA71X
	EZ=3000	EZ=2.16		

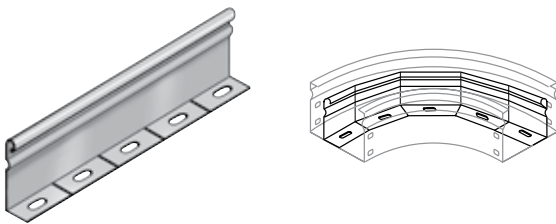

SEPARADOR PARA ACCESORIOS

Altura (mm)	Longitud (mm)	Kg	EZ	304
75	1000	0.72	31X9CA72Z	-



TORNILLO DE FIJACIÓN M6X10

Kg	EZ	316L
0.6 Kg/100	03V 1M6 10Z	03V 1M6 10L

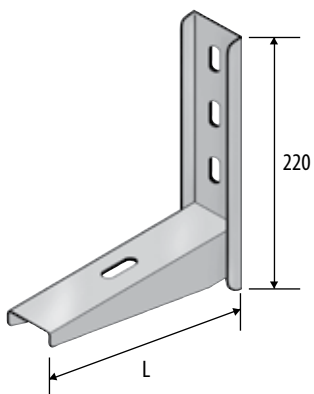

SOPORTE TIPO ESCUADRA

(mm)	a (mm)	b (mm)	Kg	EZ	316
75x75	110	50	0.70	349012	349212
75x150	162	44	0.70	349013	349213
75x300	312	32	1.20	349015	349215

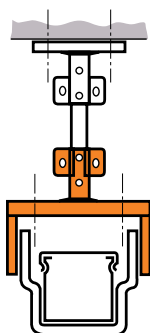
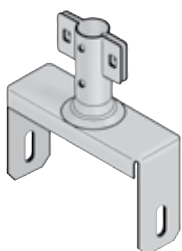

SUSPENSIÓN INFERIOR CON BRIDA

(mm)	b (mm)	d (mm)	Kg	EZ	304
75x75	75	100	0.20	341884	-
75x150	150	175	0.28	341886	-
75x300	300	325	0.39	341888	-

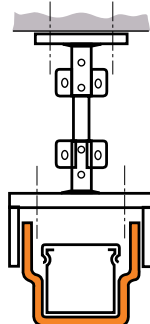
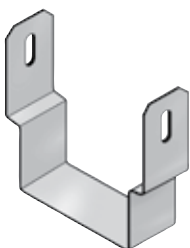

SOPORTE TIPO CUNA

(mm)	b (mm)	Kg	EZ	304
75x75	75	0.16	341863	-
75x150	150	0.20	341865	-
75x300	300	0.36	341867	-

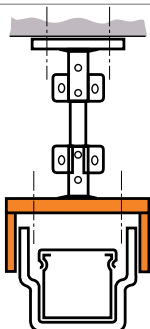
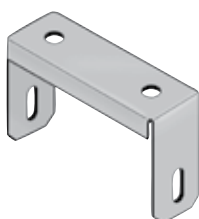

SOPORTE DE JINETILLO PARA FIJACIÓN A TECHO

(mm)	b (mm)	d (mm)	Kg	EZ	304
75x75	75	100	0.27	341877	-
75x150	150	175	0.30	341879	-
75x300	300	325	0.52	341881	-

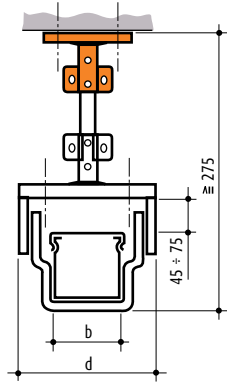

SUSPENSIÓN SUPERIOR CON BRIDA

Kg	EZ	304
0.18	341882	-

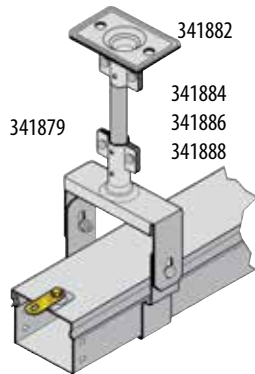
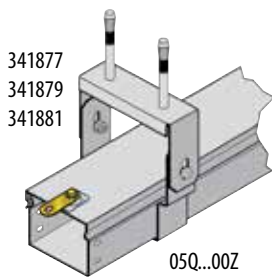

05Q...00Z

TUBO PARA SUSPENSIÓN (TRAMO 3m DE LONGITUD)



Longitud	Kg	EZ	304
3000	0.50 Kg/m	341889	-

HORQUILLA DE SUSPENSIÓN



Kg	EZ	304
0.30	349 031	-

CATÁLOGO CONDENSADO

TRAMOS RECTOS

TAPA PARA TRAMO RECTO

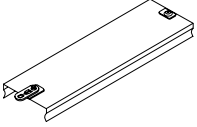
	Longitud 2 metros		Longitud 3 metros		Longitud 2 metros		Longitud 3 metros	
	EZ	304			EZ	304		
								
75 X 75 mm	31C2C075Z		31C3C075X		31L29075Z		31L39075X	
150 X 75 mm	31C2C150Z		31C3C150X		31L29150Z		31L39150X	
300 X 75 mm	31C2C300Z		31C3C300X		31L29300Z		31L39300X	

ÁNGULOS Y CAMBIO DE NIVEL

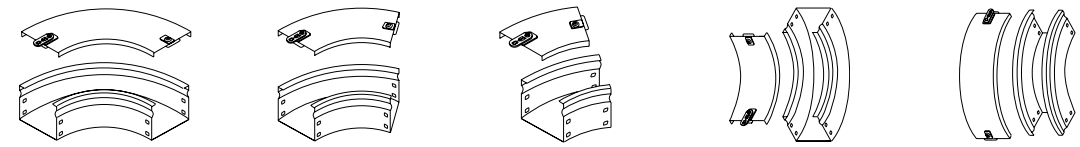
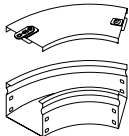
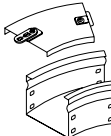
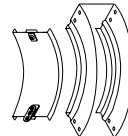
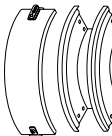
	Ángulo plano		Ángulo plano a 45°		Ángulo plano a 30°		Cambio de nivel cóncavo a 90°		Cambio de nivel convexo a 90°	
	EZ	304	EZ	304	EZ	304	EZ	304	EZ	304
										
75 X 75 mm	31AIC075Z	31AIC075X	31AJC075Z	31AJC075X	31ALC075Z		31AMC075Z	31AMC075X	31APC075Z	31APC075X
150 X 75 mm	31AIC150Z	31AIC150X	31AJC150Z	31AJC150X	31ALC150Z		31AMC150Z	31AMC150X	31APC150Z	31APC150X
300 X 75 mm	31AIC300Z	31AIC300X	31AJC300Z	31AJC300X	31ALC300Z		31AMC300Z	31AMC300X	31APC300Z	31APC300X

DERIVACIONES

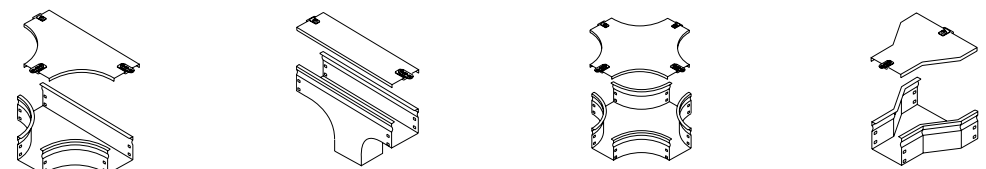
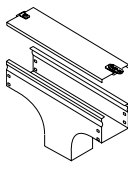
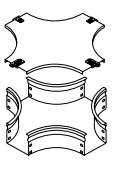
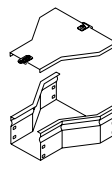
	Derivación plana en "T"		Derivación vertical en "T"		Derivación plana en "X"		Reducción concéntrica	
	EZ	304	EZ	304	EZ	304	EZ	
								
75 X 75 mm	31ASC075Z	31ASC075X	31AWC075Z	31AWC075X	31ATC075Z	31ATC075X	31AHCC33Z*	
150 X 75 mm	31ASC150Z	31ASC150X	31AWC150Z	31AWC150X	31ATC150Z	31ATC150X	31AHC75Z**	
300 X 75 mm	31ASC300Z	31ASC300X	31AWC300Z	31AWC300X	31ATC300Z	31ATC300X		

ÁNGULOS Y CAMBIO DE NIVEL

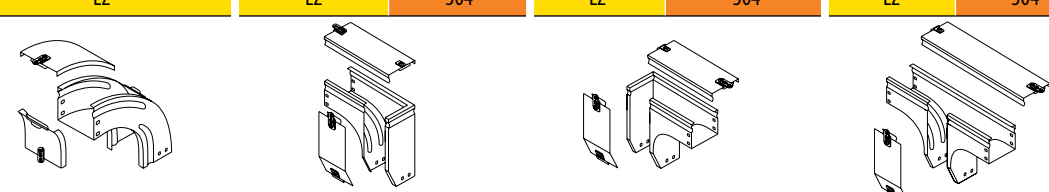
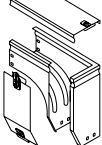
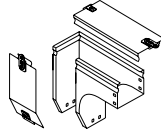
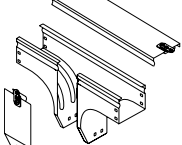
	Curva vertical a 90°		Cambio de nivel a 90° izquierdo		Cambio de nivel a 90° derecho		Derivación vertical en "T" con variación	
	EZ		EZ	304	EZ	304	EZ	304
								
75 X 75 mm	31AUC075Z		31AYC075Z	31AYC075X	31AZC075Z	31AZC075X	31AXC075Z	31AXC075X
150 X 75 mm	31AUC150Z		31AYC150Z	31AYC150X	31AZC150Z	31AZC150X	31AXC150Z	31AXC150X
300 X 75 mm	31AUC300Z		31AYC300Z	31AYC300X	31AZC300Z	31AZC300X	31AXC300Z	31AXC300X

* DE 150 A 750 MM.

** DE 300 A 150 MM.

ELEMENTOS DE UNIÓN O ACCESORIOS

	Conector rápido		Conector		Tapa final		Acometida a cuadro	Clip de fijación para tapa	Placa de conexión a tierra		Tornillo fijación M6X10	
	EZ	316	EZ	316	EZ	304	EZ	EZ	EZ	304	EZ	316
75 X 75 mm	31X9CG73Z	31X9CG73L	31X9CG71Z	31X9CG71L	31X9CC71Z	31X9CC71X	31X9CL71Z	31X99Y999	31X99X999	31X99X999	03V 1M6 10Z	
150 X 75 mm	31X9CG73Z	31X9CG73L	31X9CG71Z	31X9CG71L	31X9CC73Z	31X9CC73X	31X9CL73Z	31X99Y999	31X99X999	31X99X999	03V 1M6 10Z	
300 X 75 mm	31X9CG73Z	31X9CG73L	31X9CG71Z	31X9CG71L	31X9CC75Z	31X9CC75X	31X9CL75Z	31X99Y999	31X99X999	31X99X999	03V 1M6 10Z	03V 1M6 10L

ELEMENTOS DE UNIÓN

	Extensión para tramos rectos (Telescopio)		Placa de fijación de cables		Separador para tramos rectos (tramo de 2 m)		Separador para accesorios (tramos de 1 m)	
	EZ	EZ	EZ	EZ	EZ	304	EZ	EZ
75 X 75 mm	31X9CT71Z		31X99J99Z					
150 X 75 mm	31X9CT73Z		31X99J99Z		31X9CA73Z	31X9CA71X	31X9CA72Z	
300 X 75 mm	31X9CT75Z		31X99J99Z					

ELEMENTOS DE SOPORTE

	Suspensión inferior con brida		Suspensión superior con brida		Tubo para suspensión (tramo de 3m)	Horquilla de suspensión	
	EZ	EZ	EZ	EZ	EZ	EZ	EZ
75 X 75 mm	341884		341882		341889	349031	
150 X 75 mm	341886		341882		341889	349031	
300 X 75 mm	341888		341882		341889	349031	

ELEMENTOS DE SOPORTE

	Soporte jinetillo fijación a techo		Soporte tipo cuna		Soporte tipo escuadra	
	EZ	EZ	EZ	EZ	EZ	304
75 X 75 mm	341877		341863		349012	
150 X 75 mm	341879		341865		349013	
300 X 75 mm	341881		341867		349015	

NOTAS: Todos los accesorios (ángulos, cambios de nivel y derivaciones) incluyen la placa de conexión a tierra.
 Las placas de unión incluyen los tornillos y tuercas M6X10, necesarios para su instalación.
 Los clips de fijación, las placas de conexión a tierra y las placas de unión se surten por separado.

SELECCIÓN DEL DUCTO ADECUADO

Calibre del conductor (AWG o KCM)	Área total del conductor			Número máximo de conductores de un mismo calibre tipo: TW, THW, THW-LS, THHW		
	TW, THW THW-LS, THHW mm ²	THHN THWN, THWN-2 mm ²	XHH, XHHW XHHW-2 mm ²	Ducto 75x75 A=1114mm ² *	Ducto 150x75 A=2200mm ² *	Ducto 300x75 A=4440mm ² *
14	8.97	6.26	8.97	124	245	494
12	11.7	8.58	11.68	95	188	379
10	15.7	13.6	15.68	70	140	282
8	28.2	23.6	28.19	39	78	157
6	46.8	32.7	38.06	23	47	94
4	62.8	53.2	52.5 2	17	35	70
2	86	74.7	73.94	12	25	51
1/0	143	120	117.74	7	15	31
2/0	169	143	141.29	6	13	26
3/0	201	173	170.45	5	10	22
4/0	240	209	206.26	4	9	18
250	297	256	251.87	3	7	14
300	341	297	292.64	3	6	13
350	384	338	333.29	2	5	11
400	427	378	373.03	2	5	10
500	510	456	450.58	2	4	8
600	628	560	561.87	1	3	7
750	710	677	679.48	1	3	6

* El número máximo de conductores aquí reflejado está en función del 20% del área transversal del ducto. Según especifica la NOM 001 SEDE 2005, Art. 362 parte A.

NOM 001 ARTÍCULO 362-5

NÚMERO DE CONDUCTORES.

Los ductos no deben contener más de 30 conductores de fase en ninguna parte. No se consideran conductores de fase los de circuitos de señalización o los conductores de control y su controlador, utilizados únicamente para el arranque del motor.

La suma del área de la sección transversal de todos los conductores contenidos en cualquier lugar del ducto no debe superar 20% del área de la sección transversal interior del mismo.

No se deben aplicar los factores de corrección del Artículo 310-15(g) de las Notas de las Tablas de capacidad de conducción de corriente de 0 a 2000 V, a los 30 conductores de fase que ocupen 20% del espacio, como se especificó anteriormente.

Excepción 1: Cuando se aplique los factores de corrección especificados en el Artículo 310-15(g) de las Notas a las Tablas de capacidad de conducción de corriente de 0 a 2000 V, no se debe limitar el número de conductores de fase, pero la suma del área de la sección transversal de todos los conductores contenidos en cualquier lugar del ducto no debe exceder 20% del área de la sección transversal interior del mismo.

Excepción 2: Como se establece en 520-6, la limitación a 30 conductores no se debe aplicar en teatros ni locales similares.

Excepción 3: Como se establece en 620-32, la limitación de 20% de ocupación no se debe aplicar para elevadores y montacargas.

Número máximo de conductores de un mismo calibre tipo: THHN, THWN, THWN-2			Número máximo de conductores de un mismo calibre tipo: XHH, XHHW, XHHW-2		
Ducto 75x75 A=1114mm ² *	Ducto 150x75 A=2200mm ² *	Ducto 300x75 A=4440mm ² *	Ducto 75x75 A=1114mm ² *	Ducto 150x75 A=2200mm ² *	Ducto 300x75 A=4440mm ² *
177	351	709	124	245	494
129	256	517	95	188	380
81	161	326	71	140	283
47	93	188	39	78	157
34	67	135	29	57	116
20	41	83	21	41	84
14	29	59	15	29	60
9	18	37	9	18	37
7	15	31	7	15	31
6	12	25	6	12	26
5	10	21	5	10	21
4	8	17	4	8	17
3	7	14	3	7	15
3	6	13	3	6	13
2	5	11	2	5	11
2	4	9	2	5	9
1	3	7	1	4	7
1	3	6	1	3	6

NOM 001**ARTÍCULO 362-8****SOPORTES.**

Los ductos se deben sujetar de acuerdo con lo siguiente:

a) Soporte horizontal. Cuando se instalen horizontalmente, los ductos se deben sujetar a intervalos que no excedan 1.5 m o para tramos que excedan 1.5 m, en cada extremo o unión, excepto si están aprobados y listados para otros intervalos. La distancia entre los soportes no debe exceder de 3 m.

b) Soporte vertical. Los tramos verticales de ductos se deben sujetar firmemente a intervalos que no excedan de 4.5 m y no debe haber más de una unión entre dos soportes. Las secciones unidas de los ductos se deben sujetar firmemente, de modo que constituyan una junta rígida.



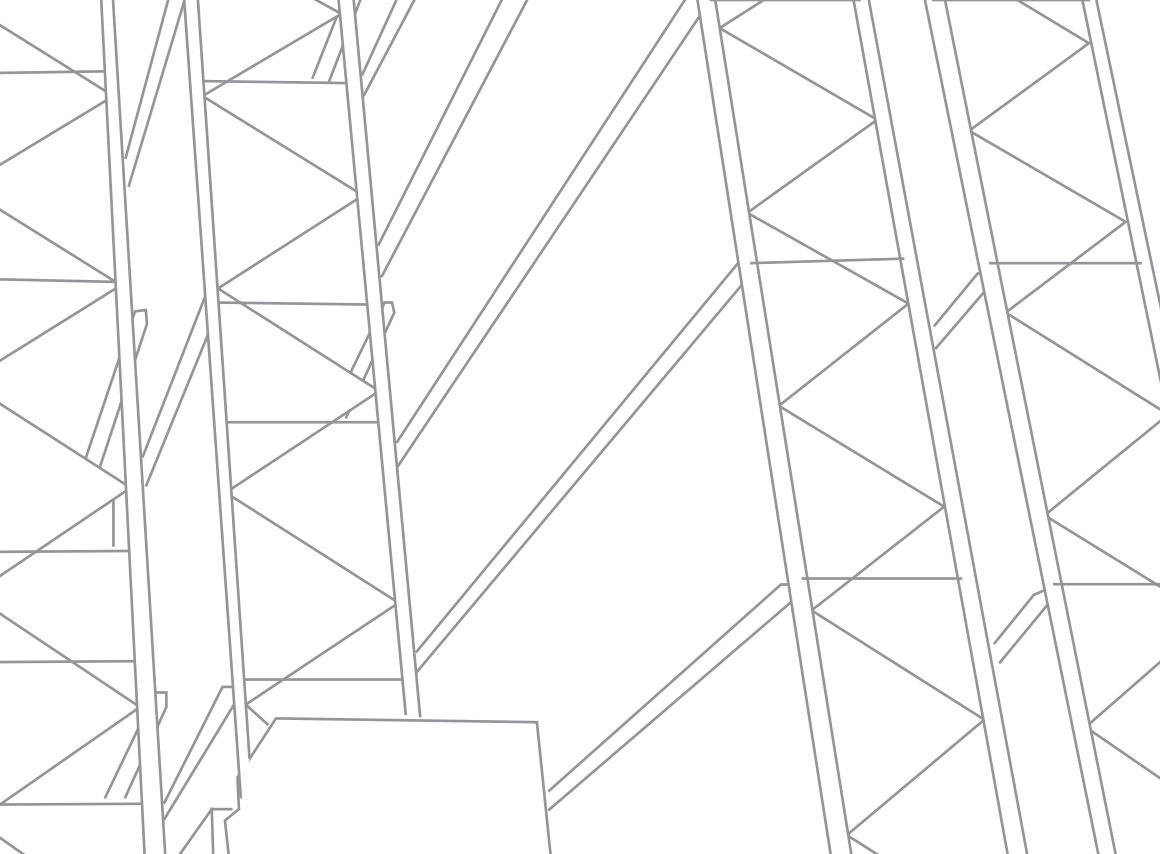

Índice

134-146		
Charola PVC	Características generales	134
	Certificaciones	136
	Pruebas	138
	Curvas, soportes y accesorios	140
	Oferta	142
	Datos dimensionales	143
	Características técnicas	146

CHAROLA PVC

El sistema está diseñado para ofrecer mayor capacidad de carga y resistencia contra agentes químicos y condiciones ambientales severas*, así como compatibilidad con diversos tipos de soportes y tiempos de instalación más cortos.

El perfil AVANT base standard, especificado para las charolas con ancho de 75, 100 y 150 mm.

El perfil AVANT, especificado para las charolas con ancho de 200, 300 y 400 mm, le proporciona características mecánicas muy superiores respecto a los perfiles convencionales; como un 20% más en capacidad de carga.

La base de las charolas presenta una doble perforación que permite la fijación a soportes de PVC y soportes metálicos.

Perfil AVANT base Standard



Perfil AVANT



Tapa de tramo recto



Se ajusta al perfil de la charola, proporcionando una mayor rigidez mecánica.

Tapa final

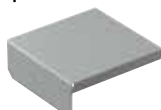

Tapa para la terminación de finales de tramos y acoplamiento entre charolas de diferentes medidas.

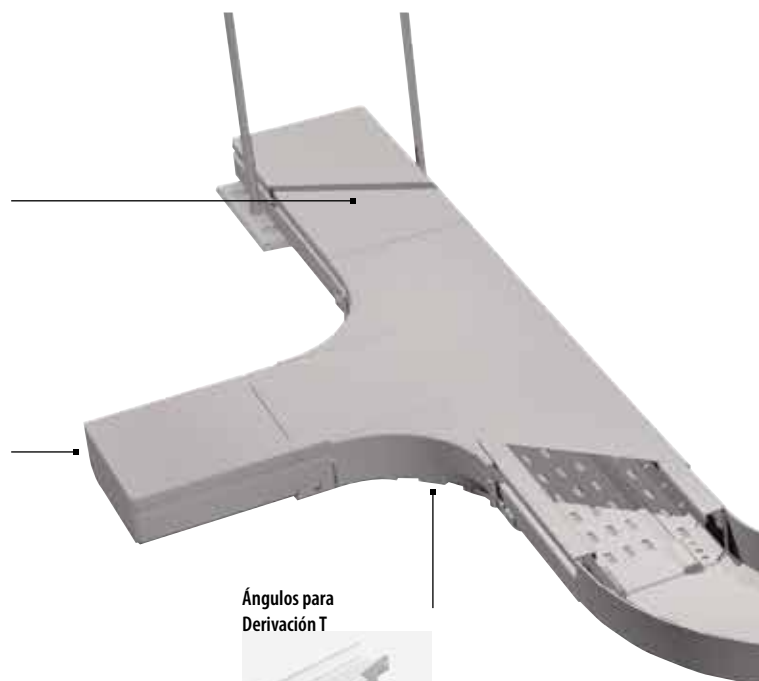

Ángulos para Derivación T



Dos ángulos laterales con tapa forman la Derivación T, cubriendo 6 dimensiones diferentes de charola con un solo código.

* Ver tabla de características técnicas en pág. 137 y tabla de resistencia a agentes químicos en pág. 146.

Tornillo PVC



Fabricados en PVC, evitando el deterioro en ambientes corrosivos.

Perfil U



Perfil para generar soportes verticales y de suspensión, con los cuales también es posible instalar soportes de posición horizontal utilizando soportes universales.

Charola PVC

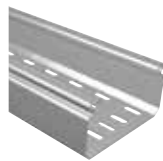

Charola con perforado de dos dimensiones que permite la sujeción de conductores mediante collarines Colring™.

Curva horizontal 90°



Con tapa incluida, no requiere piezas de enlace para acoplarse a la charola, sólo tornillos para asegurarse a ella.

Bisagras



Para generar ángulos verticales interiores y exteriores.

Tabique de separación

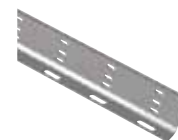

Permite dividir internamente la charola para separar cables de fuerza y de control, evitando interferencias.

Unión de tramos



Se ajusta perfectamente al perfil de la charola, permitiendo una unión exacta de tramos.

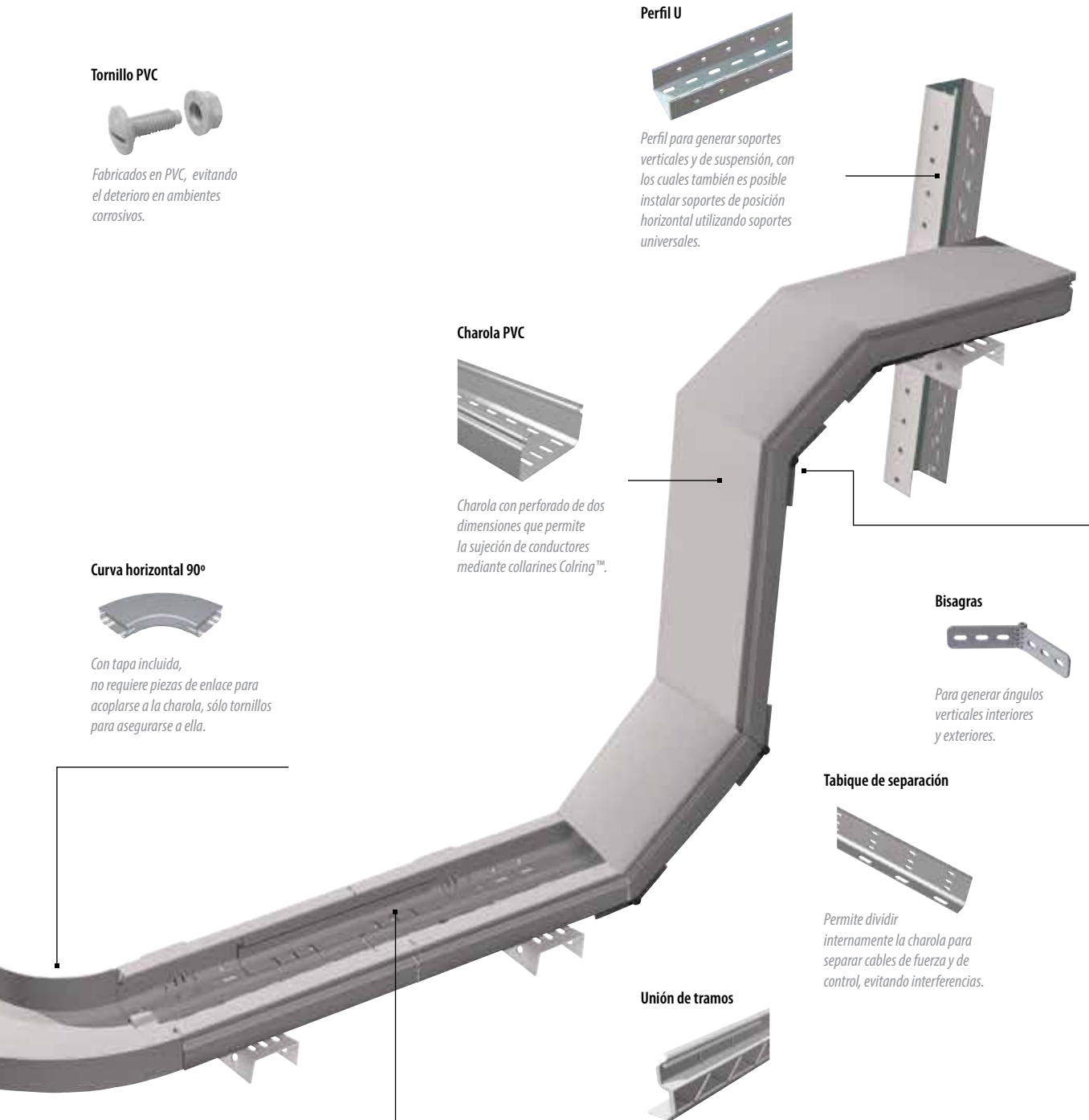

CERTIFICACIONES

El sistema de Charola PVC Legrand está certificado por AENOR según la Norma Europea UNE-EN61537, que a su vez adopta la Norma Internacional CEI 61537: 2001.

Esta certificación asegura el cumplimiento de los más exigentes requisitos de seguridad mecánica y eléctrica.



LICENCE

Accréditation N° 5-0014

L C I E

NF

LCE N° 600396130

DELIVRÉ À / DELIVERED TO: **INOVAC SAS**
B.P. 36 - Route d'Evron - 72140 SELLE LE GUILLAUME - FRANCE

SITE DE FABRICATION / FACTORY: **0706CO**

PRODUIT / PRODUCT: **SYSTEME DE CHEMIN DE CABLES / CABLE TRAY SYSTEM**

MARQUE COMMERCIALE (S'IL Y A LIEU) / TRADE MARK (IF ANY): **LEGRAND**

MODÈLE, TYPE, RÉFÉRENCE / MODEL, TYPE, REFERENCE: Références/références : voir annexes/see annex (2 pages)

Caractéristiques nominales et principales / Rating and principal characteristics: hauteur/height 75mm, non métallique/non metallic, non propage de la flamme/non-flame propagation, sans caractéristique de continuité électrique/without electrical continuity, composant non conducteur/matériau non-conductive, composant non revêtu/matériau non-coating, classification : -5°C 40°C - portée/span : 1,50m - C - portée/span : 1m - perforation : A pour non perforé/A for not perforated/B pour perforé/B for perforated

Informations complémentaires / Additional informations: Maintien licence n° 600395781 - changement références et marque commerciale/maintain licence n° 600395781 - change references and trade mark

Le produit est conforme à / The product is in conformity with: EN 61537:2001

Documents pris en compte / Relevant documents: TR SMT/CO28/0032, SMT/CO28/0034-a, SMT/CO28/0049

Annule et remplace (s'il y a lieu) / Cancels and replaces (if necessary): /

Cette licence autorise l'usage de la marque NF pour le produit dans les conditions du règlement de la marque NF, pour autant que les exigences relatives de la fabrication et les vérifications par tierce partie soient satisfaisantes.
Par mandat de AFAG AFNOR Certification et pour la LCEI.
Fontenay-aux-Roses, 2005-11-21

Date limite de validité : Néant
Limit expired date : Nil

Michel BRENON
Responsable de la certification manager

LICENCE

Accréditation N° 5-0014

L C I E

NF

LCE N° 600396130

DELIVRÉ À / DELIVERED TO: **INOVAC SAS**
B.P. 36 - Route d'Evron - 72140 SELLE LE GUILLAUME - FRANCE

SITE DE FABRICATION / FACTORY: **0706CO**

PRODUIT / PRODUCT: **SYSTEME DE CHEMIN DE CABLES / CABLE TRAY SYSTEM**

MARQUE COMMERCIALE (S'IL Y A LIEU) / TRADE MARK (IF ANY): **LEGRAND**

MODÈLE, TYPE, RÉFÉRENCE / MODEL, TYPE, REFERENCE: Références/références : voir annexes/see annex (2 pages)

Caractéristiques nominales et principales / Rating and principal characteristics: hauteur/height 100mm, non métallique/non metallic, non propageur de la flamme/non-flame propagation, sans caractéristique de continuité électrique/without electrical continuity, composant non conducteur/matériau non-conductive, composant non revêtu/matériau non-coating, classification : -5°C 40°C - portée/span : 1,50m - 40°C 60°C - portée/span : 1m - perforation : A pour non perforé/A for not perforated/B pour perforé/B for perforated

Informations complémentaires / Additional informations: Maintien licence n° 600395785 - changement références et marque commerciale/maintain licence n° 600395785 - change references and trade mark

Le produit est conforme à / The product is in conformity with: EN 61537:2001

Documents pris en compte / Relevant documents: TR SMT/CO28/0033, SMT/CO28/0050

Annule et remplace (s'il y a lieu) / Cancels and replaces (if necessary): /

Cette licence autorise l'usage de la marque NF pour le produit dans les conditions du règlement de la marque NF, pour autant que les exigences relatives de la fabrication et les vérifications par tierce partie soient satisfaisantes.
Par mandat de AFAG AFNOR Certification et pour la LCEI.
Fontenay-aux-Roses, 2005-11-21

Date limite de validité : Néant
Limit expired date : Nil

Michel BRENON
Responsable de la certification manager

La materia prima con que está fabricada la Charola PVC Legrand cuenta con la certificación UL94 e IEC 60695-2-11; la cual permite superar pruebas de resistencia al fuego.

A partir del 1ro. de julio de 2006, la Charola PVC cumple con los requerimientos de la directiva RoHS, que estipula la eliminación de diversas sustancias que son peligrosas para el medio ambiente y la salud.

QMFZ2.E242033
Plastics - Component

Plastics - Component

PLANET-WATTOHM S N C E242033
 AVE FELIX LOUAT
 BOITE POSTALE 90060
 ZACE
 60303 SENLIS CEDEX, FRANCE

Material Dsg	Color	Min. Thk mm	Flame Class	H H		RTI			H	D
				W	A	Elec	Mech	T	9	T
				I	I	Imp	Str	R	5	I
Polyvinylchloride (PVC), furnished as pellets.										
96151	GY	1.2	V-0	-	-	50	50	50		

Marking: Company name and material designation on container, wrapper or finished part.

This page and all contents are Copyright © 2004 by Underwriters Laboratories Inc. ®

The appearance of a company's name or product in this database does not in itself assure that products so identified have been manufactured under UL's Follow-Up Service. Only those products bearing the UL Mark should be considered to be Listed and covered under UL's Follow-Up Service. Always look for the Mark on the product.

UL permits the reproduction of the material contained on UL's Website subject to the following conditions: 1. The Guide Information, Designs and/or Listings (files) must be presented in their entirety and in a non-misleading manner, without any manipulation of the data (or drawings). 2. The statement "Reprinted from the Online Certifications Directory with permission from Underwriters Laboratories Inc." must appear adjacent to the extracted material. In addition, the reprinted material must include a copyright notice in the following format: "Copyright © 2004 Underwriters Laboratories Inc. ®"

Copyright © 2004 Underwriters Laboratories Inc.

Reimpreso del directorio de certificados online con permiso de Underwriters Laboratories Inc.

RESUMEN CARACTERÍSTICAS TÉCNICAS®

Características	Valor	Norma de referencia	Unidad de medida
Físicas			
Peso específico	1.63 ± 1	ISO 1183	g/cm ³
Absorción de agua	0.05	ISO 62	%
Mecánicas			
Carga de rotura en tracción	31 ± 1	ISO 527	MPa
Alargamiento de la ruptura	100 ± 30	ISO 527	%
Módulo de elasticidad en flexión	4400 ± 100	ISO 178	MPa
Carga en flexión	64 ± 2	ISO 178	MPa
Térmicas			
Temperatura VICAT	84 ± 1	ISO 306	°C
Temperatura de empleo	-5 / + 60	EN 61537	°C
Dilatación	<7 x 10 ⁻⁵	DIN 53752	mm/m °C
Eléctricas (Rigidez dieléctrica)			
Espesor 2.5 mm	16.3	CEI 60243-1	kVef/mm
Espesor 5.45 mm	12.1	CEI 60243-1	kVef/mm
Comportamiento frente al fuego			
Clasificación UL 94 HB	V0	UL 94	-
Clasificación M	M1	UNE 23727	-
Hilo incandescente a 960°C	10 a 20	IEC 60695-2-11	s
Índice de oxígeno	56.2 ± 1	ISO 4589-2	%
Clasificación F	F4	NFX 70-100 / NFX 10-702	-

* Ver resistencia a agentes químicos pág. 146.

PRUEBAS

CARGA DE TRABAJO ADMISIBLE (CTA):

Se realiza esta prueba para determinar cuál será la carga máxima que puede aplicarse sobre la charola.

Equipo de prueba

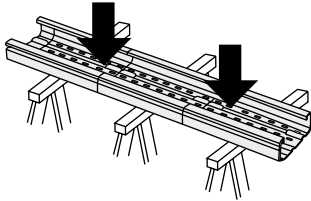

Ensayo tipo I

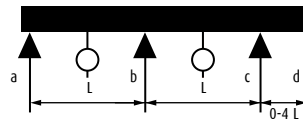

Posición de la unión en la prueba

La unión se sitúa en el punto medio entre soportes.

Posición de la unión en la instalación

Las uniones se pueden montar en cualquier posición.

Condiciones de la prueba

1. La charola se fija a los soportes A, B y C.
2. La distancia L entre los soportes es de 1.5 m.
3. La unión entre charolas se realiza en el punto medio del tramo A-B de la figura.
4. El par de apriete máximo de los tornillos es de 2.5 N-m.
5. Se distribuye una carga uniforme de 0.0025 kg/mm² de sección útil de charola por metro de longitud.

Valores para la prueba

Temperatura para la prueba 40°C.

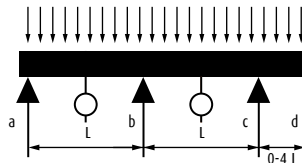

Uniones fijadas con tornillos de PVC
1 daN/m = 1kg/m

Resultados de la prueba

1. La flexión lineal máxima medida en la charola del punto medio de los tramos A-B- y C-D es inferior o igual al 1% de la distancia entre los apoyos L.
2. La flexión transversal máxima medida en la charola del punto medio de los tramos A-B- y C-D es inferior o igual al 5% del ancho de la charola.
3. La charola es capaz de soportar 1.7 veces la carga admisible sin problemas.

Después de aplicar la prueba, podemos asegurar que la Charola PVC es capaz de soportar los valores de carga máxima mencionados en la tabla, con soportes de fijación a una separación máxima de 1.5 m.

Carga de trabajo admisible (DaN/m) CTA	Ancho de la charola (mm)							
	Perfil AVANT Base Standard				Perfil AVANT			
	75	100	150	200	300	400	500	600
Altura del perfil (mm) 75	12.0	16.0	25.0	35.0	48.0	70.0	-	-

1 daN/m = 1kg/m

RESISTENCIA AL IMPACTO

Esta prueba se realiza para asegurar que la Charola PVC tiene una resistencia a los choques mecánicos adecuada para una instalación.

EQUIPO DE PRUEBA

Valores de la prueba

Previamente, las charolas se acondicionaron a una temperatura de 60°C durante 240 horas. Posteriormente, se mantiene a la temperatura declarada de -5°C durante 2 horas. Se aplica un impacto en caída de péndulo con una masa y altura determinadas de acuerdo a la tabla.

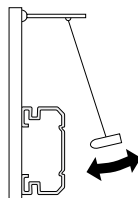

Energía de impacto	Masa del martillo (kg)	Altura de la caída (mm)
2	0.5	400
5	1.7	295
10	5	200
20	5	400
50	10	500

Después de la aplicación de la prueba, la charola no muestra señales de ruptura que afecten la seguridad en la instalación, por lo tanto se pueden considerar los siguientes valores de resistencia de choque:

Resistencia al impacto (joules)	Ancho de la charola (mm)							
	Perfil AVANT Base Standard				Perfil AVANT			
	75	100	150	200	300	400	300	600
Altura del perfil (mm) 75	5	10	10	20	20	20	-	-

RESISTENCIA AL FUEGO

Esta prueba se realiza para evaluar el comportamiento que puede tener la charola al inicio del fuego. En la prueba se pone en contacto la Charola PVC con un hilo incandescente que simula el calentamiento anormal de un cable eléctrico producido por fallo o corto circuito en la instalación.

Equipo de prueba

Valores para la prueba

1. Se aplica un hilo incandescente a 650°C durante 30 segundos y después se retira.
2. Se coloca un papel muselina en la base para detectar posibles goteos de material.

Resultados de la prueba

1. La llama se ha apagado 30 segundos después de retirar el hilo incandescente.
2. No se ha producido goteo de material que pudiera encender el papel muselina.

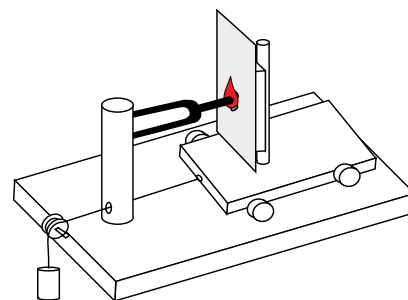

Después de que se ha aplicado la prueba, podemos asegurar que la charola no será motivo o causante de iniciar un fuego en una instalación segura.

NO PROPAGACIÓN DEL FUEGO

Esta prueba se realiza para evaluar el comportamiento que puede tener la Charola PVC durante un eventual incendio. Ésta asegura que la Charola PVC se inflama únicamente durante el contacto con una flama, pero cuando ésta desaparece, la charola dejará de quemarse.

Equipo de prueba

Valores para la prueba

1. Se aplica una flama durante 30 segundos y después se retira.
2. Se coloca un papel muselina en la base para detectar posibles goteos de material.

Resultados de la prueba

- 30 segundos después de retirar la flama.
1. No se ha producido goteo de material que pudiera encender el papel muselina.
2. No se ven rastros quemados en la charola, por encima del punto de aplicación de la flama.

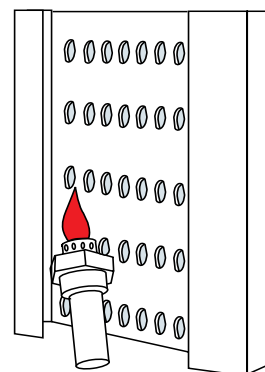

Después de aplicada la prueba, podemos asegurar que la Charola PVC no será un factor propagador del fuego, gracias a que está fabricada con material autoextinguible. Esta prueba da una clasificación M1 de material combustible pero no inflamable y de baja opacidad de humos.

SEGURIDAD ELÉCTRICA

El sistema de la Charola PVC Legrand está fabricado de material aislante por lo que proporciona una seguridad eléctrica completa en la instalación por la naturaleza propia del material; esto elimina la necesidad de conectar la charola a un sistema de tierra.

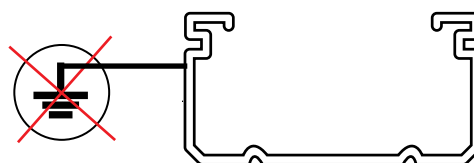

CURVAS, SOPORTES Y ACCESORIOS

BISAGRAS

Para generar ángulos ascendentes y descendentes desde 90° hasta 180° en la instalación.



CURVA VERTICAL INTERIOR 90°

Se pueden formar curvas verticales interiores con un conjunto de cuatro bisagras, tornillos y segmentos de charola cortados con el ángulo y distancias que se indican en la figura.

- a = valor de ancho de charola
- b = a + 84 mm
- c ≥ 370 mm
- d = altura
- β = 67°

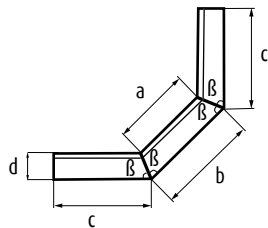

CURVA VERTICAL EXTERIOR 90°

Se pueden formar curvas verticales exteriores con un conjunto de cuatro bisagras, tornillos y segmentos de charola cortados con el ángulo y distancias que se indican en la figura.

- a = valor de ancho de charola
- b = a + 84 mm
- c ≥ 370 mm
- d = altura
- ∂ = 113°

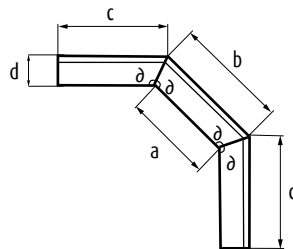

CURVAS VERTICALES INTERIORES Y EXTERIORES (PREFORMADAS)

Con tapa incluida. (Sólo bajo pedido)



ÁNGULOS PARA DERIVACIÓN T

Para generar una derivación T, se utilizan los ángulos y se realiza el corte sobre la charola de acuerdo al siguiente esquema:

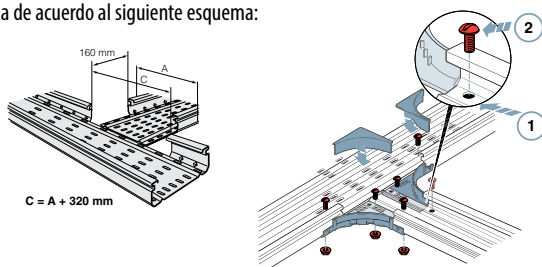

UNIÓN DE TRAMOS

Para el enlace de dos tramos rectos.

A = separación requerida para variaciones de temperatura

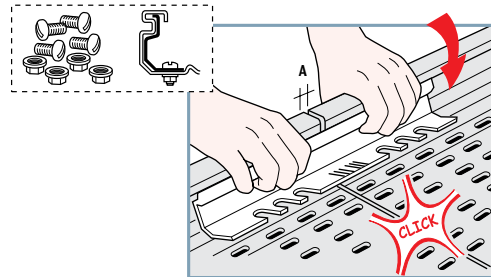
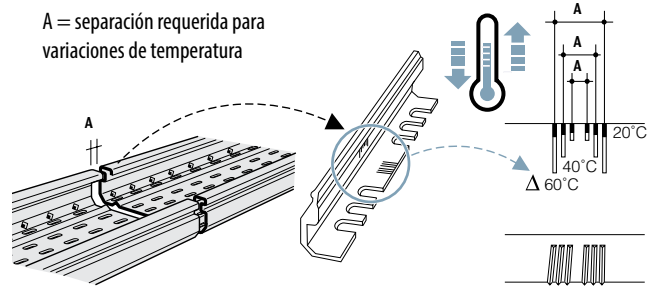

Perfil AVANT base STANDARD

75-150



Perfil AVANT

200-600



PERFIL U, SOPORTE UNIVERSAL

Accesorios de montaje e instalación que nos permiten armar el soporte horizontal, vertical y de suspensión. Con sólo dos códigos (perfil U y soporte universal) se pueden generar todos los soportes; sólo se corta el perfil U de acuerdo al ancho de la charola.

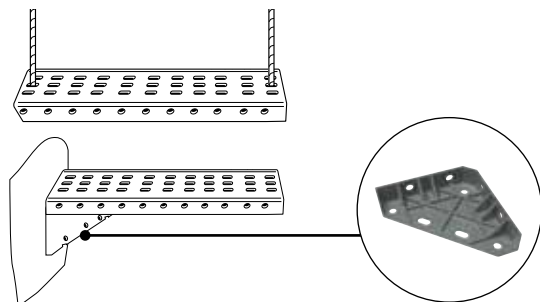

SOPORTE HORIZONTAL, VERTICAL Y SUSPENSIÓN (PREFORMADOS)

Cuenta con un código para cada medida de charola. (Sólo bajo pedido)



Tabla 1

CHAROLA PVC: TRAMOS RECTOS, COMPLEMENTOS Y ACCESORIOS

CHAROLA PVC		COMPLEMENTOS										ACCESORIOS			
Ancho x altura Sección (mm)	Tramos rectos perforados	Tapa de tramo recto	Tabique de separación	Curva horizontal 90° con tapa	Curva vertical interior 90° con tapa	Curva vertical exterior 90° con tapa	Tapa final	Ángulos para Derivación T	Adapador de unión	Adapador de unión PVC Acero*	soporte vertical	soporte de suspensión	bisagras		
75 x 75	637 801	637 760	637 888	637 803	-	637 807	637 808	637 860	637 890	637 766	637 781	637 771	637 793	Perfil U PVC	637 950
100 x 75	637 811	637 761	637 888	637 813	637 815	637 817	637 818	637 860	637 890	637 766	637 781	637 771	637 793	Tornillo PVC	637 953
150 x 75	637 821	637 762	637 888	637 823	637 825	637 827	637 828	637 860	637 890	637 767	637 782	637 772	637 793	Tornillo acero	637 987
200 x 75	637 831	637 763	637 888	637 833	637 835	637 837	637 838	637 860	637 891	637 768	637 783	637 773	637 993	Fijación universal	637 955
300 x 75	637 841	637 764	637 888	637 843	637 845	637 847	637 848	637 860	637 891	637 769	637 784	637 774	637 993	Pasador PVC	637 951
400 x 75	637 851	637 765	637 888	637 853	-	637 857	637 858	637 860	637 891	637 979*	637 785	637 775	637 993	Pasador acero	-

* Producto en acero

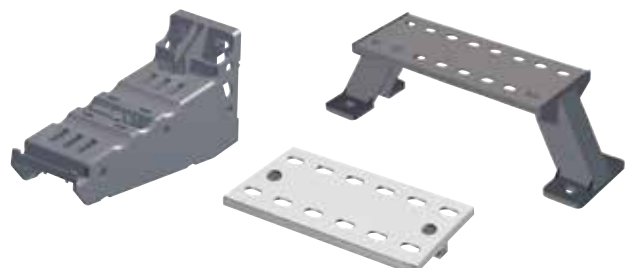
75 mm de altura

OFERTA

CHAROLA PVC PERFORADA

Emp.	Ref.	Ancho x Alto
Charola perforada (tramo de 3 m)		
8	637 801	75 x 75 mm
6	637 811	100 x 75 mm
4	637 821	150 x 75 mm
2	637 831	200 x 75 mm
2	637 841	300 x 75 mm
2	637 851	400 x 75 mm
Tapa de tramo recto (tramo de 3 m)		
8	637 760	Para charola 75 x 75 mm
8	637 761	Para charola 100 x 75 mm
6	637 762	Para charola 150 x 75 mm
4	637 763	Para charola 200 x 75 mm
4	637 764	Para charola 300 x 75 mm
4	637 765	Para charola 400 x 75 mm
Curva horizontal 90° (con tapa)		
4	637 803	Para charola de 75 x 75 mm
4	637 813	Para charola de 100 x 75 mm
4	637 823	Para charola de 150 x 75 mm
2	637 833	Para charola de 200 x 75 mm
2	637 843	Para charola de 300 x 75 mm
1	637 853	Para charola de 400 x 75 mm
Curva vertical interior 90° (con tapa)		
4	637 815	Para charola de 100 x 75 mm
4	637 825	Para charola de 150 x 75 mm
2	637 835	Para charola de 200 x 75 mm
2	637 845	Para charola de 300 x 75 mm
1	637 855	Para charola de 400 x 75 mm
Curva vertical exterior 90° (con tapa)		
4	637 807	Para charola de 75 x 75 mm
4	637 817	Para charola de 100 x 75 mm
4	637 827	Para charola de 150 x 75 mm
2	637 837	Para charola de 200 x 75 mm
2	637 847	Para charola de 300 x 75 mm
1	637 857	Para charola de 400 x 75 mm
Tapa final		
2	637 808	Para charola de 75 x 75 mm
2	637 818	Para charola de 100 x 75 mm
2	637 828	Para charola de 150 x 75 mm
2	637 838	Para charola de 200 x 75 mm
2	637 848	Para charola de 300 x 75 mm
2	637 858	Para charola de 400 x 75 mm
Soporte horizontal		

Emp.	Ref.	Ancho x Alto
8	637 766	Para charola de 75/100 x 75 mm
6	637 767	Para charola de 150 x 75 mm
4	637 768	Para charola de 200 x 75 mm
4	637 769	Para charola de 300 x 75 mm
2	637 799	Para charola de 400 x 75 mm (acero)
Soporte vertical		
8	637 781	Para charola de 75/100 x 75 mm
6	637 782	Para charola de 150 x 75 mm
4	637 783	Para charola de 200 x 75 mm
4	637 784	Para charola de 300 x 75 mm
4	637 785	Para charola de 400 x 75 mm
Soporte de suspensión		
8	637 771	Para charola de 75/100 x 75 mm
6	637 772	Para charola de 150 x 75 mm
4	637 773	Para charola de 200 x 75 mm
4	637 774	Para charola de 300 x 75 mm
4	637 775	Para charola de 400 x 75 mm
Tabique de separación (tramo de 3 m)		
10	637 888	Para charola altura 75 mm
8	637 988	Para charola altura 100 mm
Ángulos para Derivación T. Incluye 2 ángulos con tapa.		
2	637 860	Para charola altura 75 mm
2	637 960	Para charola altura 100 mm
Unión de tramos de charola		
20	637 890	Para charola 75-150 x 75 mm
20	637 891	Para charola 200-400 x 75 mm
Bisagras		
20	637 793	Para ancho 75-150 mm
20	637 993	Para ancho 200-600 mm
100	637 951	Pasador de PVC
4	637 950	Perfil U PVC
100	637 953	Tornillo de PVC
100	637 987	Tornillo de acero inoxidable
8	637 955	Fijación universal

DATOS DIMENSIONALES CURVAS, SOPORTES Y ACCESORIOS

CHAROLA PVC, PERFIL AVANT BASE STANDARD

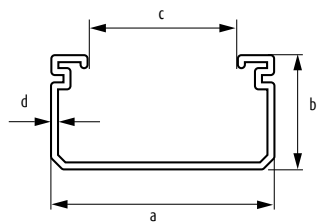

Referencia	a mm	b mm	c mm	d mm	Capacidad mm ²	Longitud mm
637 801	75	75	32	2.3	4,622	3000
637 811	100	75	57	2.3	6,440	3000
637 821	150	75.3	106.2	2.7	9,961	3000

CHAROLA PVC, PERFIL AVANT

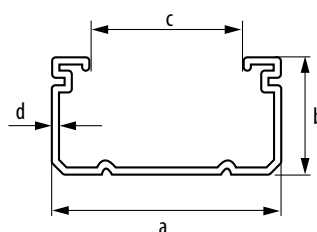

Referencia	a mm	b mm	c mm	d mm	Capacidad mm ²	Longitud mm
637 831	200	75	138.8	2.8	12,690	3000
637 841	300	77	234.4	3.8	19,601	3000
637 851	400	77.8	332.8	4.2	26,879	3000

TAPA DE TRAMO RECTO

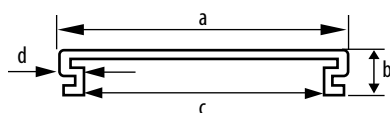

Referencia	a mm	b mm	c mm	d mm	Longitud mm
637 760	75	15.6	56.6	1.2	3000
637 761	100	15.6	31.6	31.28	3000
637 762	150	15.6	131.6	1.5	3000
637 763	200	23.9	171.6	2	3000
637 764	300	25.3	271.6	2.5	3000
637 765	400	25.3	371.6	2.5	3000

TABIQUE DE SEPARACIÓN

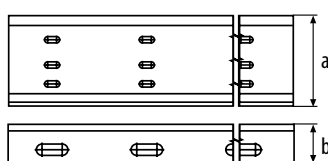

Referencia	a mm	b mm	Longitud mm
637 888	71.56	30	3000
637 988	95.16	30	3000

CURVA HORIZONTAL 90°

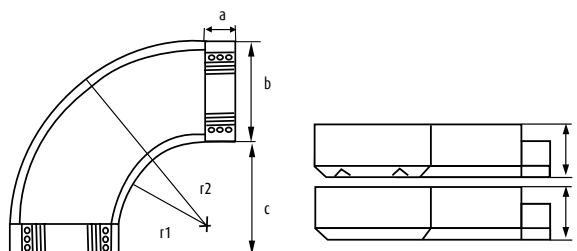

Referencia	a mm	b mm	c mm	d mm	r1 mm	r2 mm
637 803	52	68	210	75	150	224
637 813	52	93	210	75	150	249
637 823	52	142	210	75	150	298
637 833	52	190	210	75	150	346
637 843	52	289	210	75	150	445
637 853	52	388	210	75	150	544

CURVA VERTICAL EXTERIOR 90°

(Sólo bajo pedido).

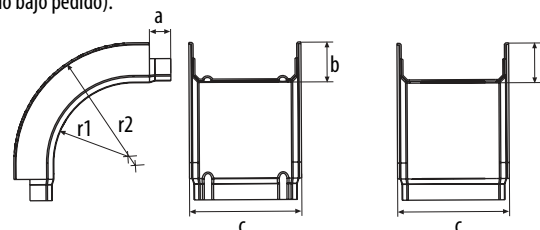

Referencia	a mm	b mm	c mm	r1 mm	r2 mm
637 815	52	75	93	150	200
637 825	52	75	142	150	200
637 833	52	75	190	150	200
637 845	52	75	289	150	200
637 855	52	75	388	150	200

CURVA VERTICAL INTERIOR 90°

(Sólo bajo pedido)

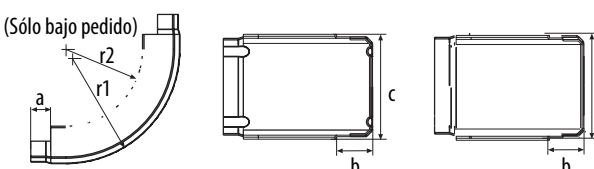

Referencia	a mm	b mm	c mm	r1 mm	r2 mm
637 807	52	75	68	150	200
637 817	52	75	93	150	200
637 827	52	75	142	150	200
637 837	52	75	190	150	200
637 847	52	75	289	150	200
637 857	52	75	388	150	200

DATOS DIMENSIONALES SOPORTES Y ACCESORIOS

TAPA FINAL

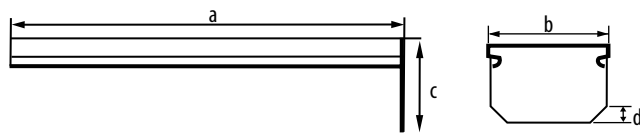

Referencia	a mm	b mm	c mm	d mm
637 808	200	75	76	11
637 818	200	100	76	11
637 828	200	150	77	11
637 838	200	200	77	13
637 848	200	300	79	14
637 858	200	400	80	15

(Sólo bajo pedido)

ÁNGULOS PARA DERIVACIÓN T

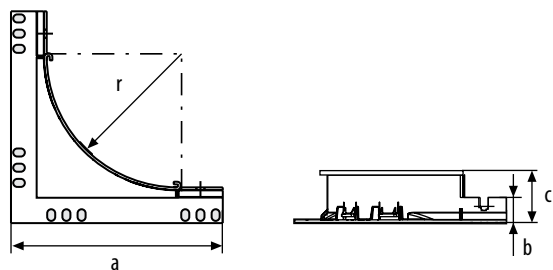

Referencia	a mm	b mm	c mm	r mm
637 860	237	28	53	150
637 960	237	28	78	150

UNIÓN DE TRAMOS PARA PERFIL AVANT BASE STANDARD

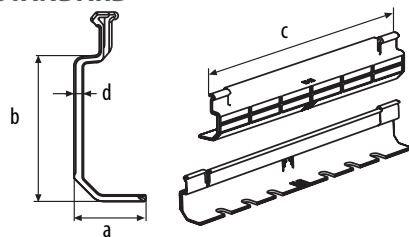

Referencia	a mm	b mm	c mm	d mm
637 890	27	70.9	275	3.6

UNIÓN DE TRAMOS PARA PERFIL AVANT

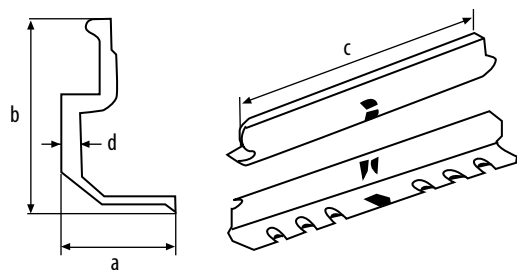

Referencia	a mm	b mm	c mm	d mm
637 891	38.8	69.8	350	7.5
637 990	38.8	92.8	450	7.5

SOPORTE HORIZONTAL

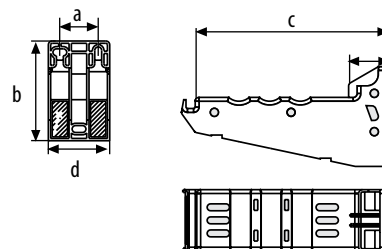

(Sólo bajo pedido)

Referencia	a mm	b mm	c mm	d mm	e mm	Carga daN
637 766	80	100	100	53	50	25
637 767	80	100	150	53	50	40
637 768	80	130	200	53	50	65
637 769	80	130	300	53	50	75
637 779	80	130	400	50	50	135

SOPORTE VERTICAL

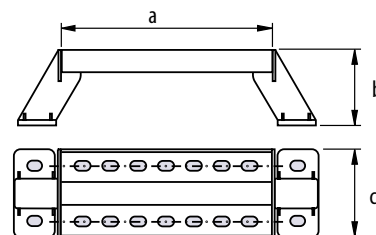

(Sólo bajo pedido)

Referencia	a mm	b mm	c mm
637 781	100	75	80
637 782	150	75	80
637 783	200	75	80
637 784	300	75	80
637 785	400	75	80

SOPORTE DE SUSPENSIÓN

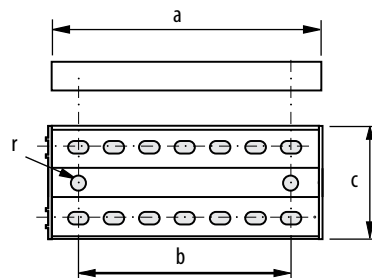

(Sólo bajo pedido)

Referencia	a mm	b mm	c mm	r mm	Carga daN
637 771	200	140	80	5	25
637 772	250	190	80	5	40
637 773	300	240	80	5	65
637 774	400	340	80	5	100
637 775	500	440	80	5	135

BISAGRAS

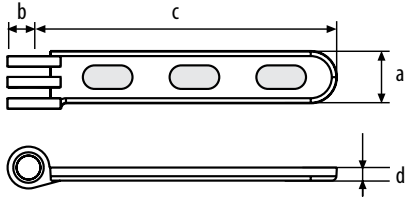

Referencia	a mm	b mm	c mm	d mm
637 793	20	8.3	118	5
637 993	40	8.3	118	5

FIJACIÓN UNIVERSAL

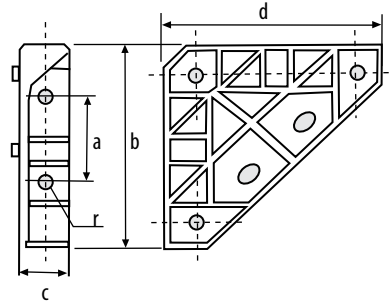

Referencia	a mm	b mm	c mm	d mm	r mm
637 955	56	136	30	136	5

PERFIL U

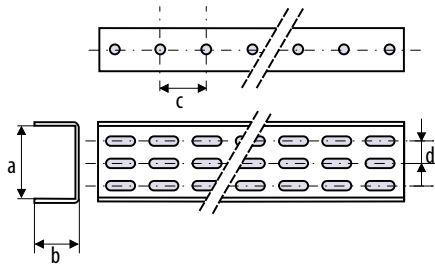

Referencia	a mm	b mm	c mm	d mm	longitud mm
637 950	83	50	50	25	2,000

PASADOR PVC

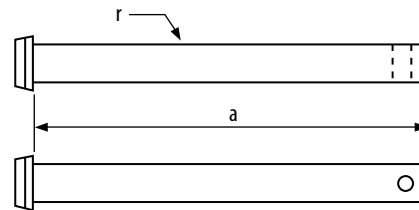

Referencia	a mm	r mm
637 951	107	5

TORNILLO PVC

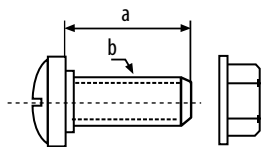

Referencia	a mm	b medida
637 953	20	M-8

TORNILLO PVC

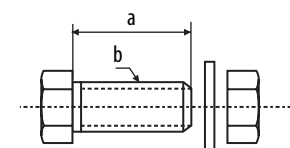

Referencia	a mm	b medida
637 987	20	M-8

CARACTERÍSTICAS TÉCNICAS

RESISTENCIA DE AGENTES QUÍMICOS PARA PVC

Las propiedades listadas a continuación deben ser tomadas como información técnica, tomando como base la experiencia común, así como el promedio de los resultados obtenidos de pruebas realizadas. Estos datos no establecen ninguna responsabilidad por parte del fabricante.

Agentes químicos	Concentración %	Temperatura °C	Resistencia PVC ⁽¹⁾
Acetaldehído	100	20	N
Acetaldehído, solución de agua	40	40	M
Ácido acético, anhídrido	100/100	20/60	N/N
Ácido acético, glacial	100/100	2/40	M/N
Ácido acético, solución de agua	hasta 25/hasta 25, 26/60/80	40/60, 60/40	R/M
Acetona	100	20	N
Acetona, solución de agua	limitado	20	N
Acetileno gaseoso, seco y húmedo	100	20	M
Ácido acrílico, etil éster	100	20	N
Aluminio (todos los tipos), solución de agua	diluido/diluido/saturado (k)	40/60/60	C
Cloruro de aluminio, solución de agua	diluido/diluido/saturado (k)	40/60/60	M/N
Sulfato de aluminio	diluido/diluido/saturado (k)	40/60/60	M/N
Amoniaco, caústico	saturado/saturado	40/60	R/M
Amoniaco, gaseoso	100	60	R
Amoniaco, líquido	100	20	M
Cloruro de amonio, solución de agua	diluido/diluido	40/60	R/M
Nitrato de amonio, solución de agua	diluido/diluido/saturado (k)	40/60/60	R/M/R
Sulfato de amonio, solución de agua	diluido/diluido/saturado (k)	40/60/60	R/R/R
Alcohol	96	20	M
Anilina, pura 100	20	N	-
Anilina, solución de agua	saturado	20	N
Aqua regia (ácido nítrico + clorhídrico)	servicio normal	20	M
Sales fertilizantes, solución de agua	saturado (k)	60	R
Cerveza	-	20	R
Benzaldehído	0-1	60	N
Benzeno	100	20	N
Ácido benzenoico, solución de agua	cualquiera	20	R
Blanqueador, activo 12 1/2 con cloro	concentrado/concentrado	40/60	R/M
Bórax, solución de agua	diluido/diluido/saturado (k)	40/60/60	R/M/M
Ácido bórico, solución de agua	diluido/diluido/saturado (k)	40/60/60	R/M/M
Bromo líquido	20	N	-
Buladieno	100	20	R
Butano, gaseoso y líquido	100	20	R
Butanol	100	20	R
Butanol, solución de agua	cualquiera	60	M
Butil, acetato	100	20	N
Butileno, líquido	100	20	R
Ácido butírico	concentrado	20	N
Cloruro de calcio, solución de agua	diluido/saturado (k)	40/60	R/M
Nitrato de calcio, solución de agua	50	40	R
Úrea, solución de agua	hasta 10/hasta 10/33	40/60/60	R/M/R
Bióxido de carbono, seco	100	60	R
Bióxido de carbono, húmedo	cualquiera	40	R

Agentes químicos	Concentración %	Temperatura °C	Resistencia PVC ⁽¹⁾
Bióxido de carbono, solución de agua a 9 bars (ácido cabónico)	saturado	20	R
Disulfuro de carbono	100	20	M
Tetracloruro de carbono	100/100	20/60	N/N
Solución de sosa cáustica	hasta 40/hasta 40/50/60	40/60/60	R/M/R
Cloramina, solución de agua	diluido	20	R
Ácido clórico, solución de agua	1/1	40/60	R/R
Cloro, gaseoso, seco	100	20	M
Cloro, húmedo	0-5/1-0	20/20	R/M
Agua de cloro	saturado	20	M
Ácido cloracético	100/100	40/60	R/M
Cloroformo	100	20	N
Ácido clorosulfónico	1000	20	M
Ácido crómico sulfato ácido/agua	80/80	20/60	R/M
Ácido cítrico, solución de agua	hasta 10/hasta 10/saturado (k)	40/60/60	R/M/R
Sulfato de cobre, solución de agua	diluido/diluido/saturado (k)	40/60/60	R/M/R
Crisol, solución de agua	hasta 90	45	R
Crotonaldehído	100	20	N
Ciclohexanol	100	20	N
Ciclohexanano	100	20	N
Dextrin, solución de agua	saturado/18	20/60	R/M
Ácido de dicromato sulfúrico (agente limpiador)	normal/servicio concentrado	20/50	M/N
Diesel	100	20	R
Dimetilamina	100	30	M
Aceites etéreos	100	60	R
Etil acetato	100	20	N
Alcohol etílico, solución de agua	cualquiera/96	20/60	R/M
Etil éter	100	20	N
Etileno, gaseoso + líquido	100	20	R
Óxido de etileno	100	20	N
Ácidos grasos (animal y vegetal)	100	60	R
Cloruro férrico, solución de agua	hasta 10/hasta 10/saturado (k)	40/60/60	M/R/R
formaldehído, solución de agua	hasta 10/hasta 10/40	40/60/60	R/M/R
Ácido fórmico 100/100	20/60	M/R	-
Ácido fórmico, solución de agua	hasta 50	40	M/R
Jugos de frutas	-	20	N
Glicerol, solución de agua	cualquiera	60	N
Glicol, solución de agua	10-100	20-60	N
Glicocol, solución de agua	10	40	N
Glucosa, solución de agua	saturado	20	M
Zumo de uva, solución de agua	saturado(k)/saturado (k)	20/60	N/M
n-Heptano	100	20	N
n-Hexano	100	20	N
Ácido hidrobromico, solución de agua	hasta 10/hasta 10	40/60	N/M
Ácido hidroclicórico, solución de agua	hasta 30/hasta 30	40/60 sobre 30/sobre 30	N/M, N/N

(1) N = No resistente R = Resistente M = Muy resistente

RESISTENCIA DE AGENTES QUÍMICOS PARA PVC

Las propiedades listadas a continuación deben ser tomadas como información técnica, tomando como base la experiencia común, así como el promedio de los resultados obtenidos de pruebas realizadas. Estos datos no establecen ninguna responsabilidad por parte del fabricante.

Agentes químicos	Concentración %	Temperatura °C	Resistencia PVC ⁽¹⁾
Gas de cloruro, cualquiera	20/60	N	seco + húmedo
Peróxido de hidrógeno, solución de agua	hasta 30/hasta 30	20/50	N/N
Sulfuro de hidrógeno, seco	100	60	N
Sulfuro de hidrógeno, solución de agua	saturado (M)/saturado (M)	40/60	N/M
Sulfato de hidroxilamina, solución de agua	hasta 12	35	N
Yodo, tintura servicios concentrados	20	R	-
Acetato de plomo, solución de agua	saturado (v)/diluido	50/40	R/R
Cloruro de magnesio, solución de agua	diluido/diluido/saturado (k)	40/60/60	R/M/R
Sulfato de magnesio, solución de agua	diluido/diluido/saturado (k)	40/60/60	R/M/R
Ácido maléico, solución de agua	saturado (k)/saturado (k)	40/60	R/M
Alcohol metílico, metanol	100/100	60/60	R/M
Metil etil cetona, MEC	100	20	N/M
Metilamina, solución de agua	32	20	M
Cloruro de metileno	100	20	R
Melaza	normal	20	R
Sulfato de níquel	diluido/diluido/saturado (k)	40/60/60	R/R/R
Ácido nítrico, solución de agua	hasta 50/98	50/20	M/N
Óxido nítrico, solución de agua	alta conc./alta conc.	20/60	R/R
Aceites minerales (combustible, aceite de motor, lubricante)	100/100	20/60	R/R
Ácido oxálico, solución de agua	diluido/diluido/saturado (k)	40/60/60	R/M/R
Ozono	100	20	R
Gasolina	100/100	20/60	R/R
Mezcla de gasolina/benceno	desde 80/20	20	R
Petróleo (crudo)	100	20	R
Fenol, solución de agua	hasta 90	45	M
Fenilhidracina	100	20	N
Fosgeno, gaseoso	100/100	20/60	R/M
Fosgeno, líquido	100	20	N
Ácido fosfórico, solución de agua	hasta 30/hasta 30/40/80/95	40/60/60	R/M/R
Pentóxido de fósforo	100	20	R
Tricloro de fósforo	100	60	N
Catalizador fotográfico	servicio conc.	40	R
Fijador fotográfico	servicio conc.	40	R
Ácido picric, solución de agua	1	20	R
Cal de potasio	hasta 40/hasta 50/60	40/60/60	R/M/R
Bromuro de potasio	diluido/diluido/saturado (k)	40/60/60	R/M/R
Carbonato de potasio, solución de agua	saturado (k)	60	R
Cloruro de potasio, solución de agua	diluido/diluido/saturado (k)	40/60/60	R/M/R
Dicromato de potasio	40	20	R
Ferrocianuro y ferricianuro de potasio, solución de agua	diluido/diluido/saturado (k)	40/60/60	R/M/R
Nitrato de potasio	diluido/diluido/saturado (k)	40/60/60	R/M/R

(1) N = No resistente R = Resistente M = Muy resistente

Agentes químicos	Concentración %	Temperatura °C	Resistencia PVC ⁽¹⁾
Perclorato de potasio, solución de agua	1/1	40/60	R/M
Permanganato de potasio, solución de agua	hasta 18	40	R
Persulfato de potasio, solución de agua	diluido/diluido	40/60	R/M
Propano, gaseoso	100	20	R
Propano, líquido	100	20	R
Pirina	100	20	N
Agua de mar	-	40/60	R/M
Ácido silico, solución de agua	cualquiera	60	R
Nitrato de plata, solución de agua	hasta 8/hasta 8	40/60	R/M
solución de jabón en agua	conc./conc.	20/60	R/M
Benzoato de sodio, solución de agua	hasta 10	40	R
Bisulfito de sodio, solución de agua	diluido/diluido/saturado (k)	40/60/60	R/M/R
Carbonato de sodio, solución de agua (soda)	diluido/diluido/saturado (k)	40/60/60	R/M/R
Clorato de sodio, solución de agua	hasta 10/hasta 10/saturado/ (k)	40/60/60	R/M/R
Cloruro de sodio, solución de agua (sal común)	diluido/diluido/saturado (k)	20/60	M/R
Hipoclorito de sodio, solución de agua	diluido	20	R
Almidón, solución de agua	cualquiera/cualquiera	40/60	R/M
Ácido estérico 100	60	M	-
Dióxido de sulfuro	100/100	10/60	M/R
Dióxido de sulfuro, seco	cualquiera	60	R
Dióxido de sulfuro, húmedo + solución de agua	50/cualquiera	50/60	R/R
Ácido sulfúrico, solución de agua	hasta 40/hasta 40/70/70	40/60/20/60	M/R/M/R
Mezcla de ácido sulfúrico/nítrico	50/50 50/50	20/40	M/R
Sebo	100	20	R
Taetril plomo	100	20	R
Tetrahidrofurán	100	20	N
Tolueno	100	20	N
Aceite para transformador	100	60	R
Trietanolamina	100	20	N
Orina	normal	40	R
Vinagre comercial/grado	-	50/60	R/M
Acetato de vinilo, líquido	100	20	N
Cloruro de vinilo, gaseoso + líquido	100	20	N
Agua (no destilada)	100/100	40/60	R/M
Whiskey y otros vinos	servicio conc.	20	R
Xileno (dimetilbenzeno, xylol)	100	20	N
Cloruro de zinc, solución de agua	diluido/saturado (k)	60/60	M/R

ÍNDICE POR CÓDIGO

Código	Descripción	Página	Línea	Código	Descripción	Página	Línea
000 011 -> 001 034	CF30, CF54, CF105, CF150	13, 14, 15, 16	CHAROLA TIPO MALLA	589 010	UFCSRBAR	51	CHAROLA TIPO MALLA
011 100	FAS ROLLER	58	CHAROLA TIPO MALLA	589 110	UFPSTCLP	51	CHAROLA TIPO MALLA
014 030 -> 014 038	RCSN	35, 41, 46, 49	CHAROLA TIPO MALLA	589 210	UFTXSPRCLP	51	CHAROLA TIPO MALLA
03V 1M6 10L -> 03 1M6 10Z	TORNILLO FIJACIÓN	125	RTGAMMA	595 013 -> 595 064	C415	33, 44, 53	CHAROLA TIPO MALLA
081 061 -> 081 094	FCF54 FASCLIC	19	CHAROLA TIPO MALLA	595 900 -> 595 920	CM 100	52	CHAROLA TIPO MALLA
091 937 -> 091 938	IBP	54	CHAROLA TIPO MALLA	595 930	UC 100	52	CHAROLA TIPO MALLA
250 018 -> 250 518	EZ-PATH	59, 60	CHAROLA TIPO MALLA	595 340	SU41	44	CHAROLA TIPO MALLA
31AHC75Z -> 31X9CS51X	REDUCCIÓN	121	RTGAMMA	595 353	UFI 41	53	CHAROLA TIPO MALLA
31AIC075X -> 31AIC300Z	ÁNGULO PLANO 90°	120	RTGAMMA	599 007 -> 599 004	FS41 FASTRUT	41, 81	CHAROLA TIPO MALLA
31AJC075X -> 31AJC300Z	ÁNGULO PLANO 45°	120	RTGAMMA	600 261 -> 600 901	UFCE 54	50	CHAROLA TIPO MALLA
31ALC075Z -> 31ALC300Z	ÁNGULO PLANO 30°	121	RTGAMMA	629 050 -> 629 604	CVN	20	CHAROLA TIPO MALLA
31AMC075X -> 31AMC300Z	CAMBIO NIVEL CÓNCAVO	122	RTGAMMA	637 760 -> 637 988	CHAROLA PVC	142 - 145	CHAROLA PVC
31APC075X -> 31APC300Z	CAMBIO NIVEL CONVEXO	122	RTGAMMA	646 010 -> 646 084	CP	20	CHAROLA TIPO MALLA
31ASC075X -> 31ASC300Z	DERIVACIÓN PLANA EN T	121	RTGAMMA	646 200 -> 646 207	CLIP F	20	CHAROLA TIPO MALLA
31ATC075X -> 31ATC300Z	DERIVACIÓN PLANA EN X	121	RTGAMMA	755 001 -> 755 008	TXF35	17	CHAROLA TIPO MALLA
31AUCC075Z -> 31AUC300Z	CURVA VERTICAL	122	RTGAMMA	755 100 -> 755 104	CP35	17	CHAROLA TIPO MALLA
31AWC075X -> 31AWC300Z	DERIVACIÓN VERTICAL T	122	RTGAMMA	801 017 -> 801 018	BTRCC	26, 27, 80	CHAROLA TIPO MALLA
31AXC075X -> 31AXC300Z	DERIVACIÓN VERTICAL T - VARIACION DE PLANO	123	RTGAMMA	840 101 -> 840 133	PA1, PA2, PA3	25	CHAROLA TIPO MALLA
31AYC075X -> 31AYC300Z	CAMBIO DE NIVEL 90° IZQUIERDA	122	RTGAMMA	923 010 -> 923 048	COT	21	CHAROLA TIPO MALLA
31AZC075X -> 31AZC300Z	CAMBIO DE NIVEL 90° DERECHO	123	RTGAMMA	923 050 -> 923 054	COT J	21	CHAROLA TIPO MALLA
31C2C075Z -> 31C3C300X	TRAMO RECTO	120	RTGAMMA	941 059	BTRCC	26, 27, 80	CHAROLA TIPO MALLA
31L29075Z -> 31L39300X	TAPA	120	RTGAMMA	941 072 -> 941 080	CF105, CF150	15, 16	CHAROLA TIPO MALLA
31X99J99Z	PLACA DE FIJACIÓN DE CABLES	124	RTGAMMA	941 084	BTRCC	26, 27, 80	CHAROLA TIPO MALLA
31X99X999 -> 31X99X99X	PLACA DE CONEXIÓN A TIERRA	124	RTGAMMA	942 354	UFS	48, 27	CHAROLA TIPO MALLA
31X99Y999	CLIP FIJACIÓN	124	RTGAMMA	942 448 -> 942 839	UFNCN	50	CHAROLA TIPO MALLA
31X9CA72Z	SEPARADOR ACCESORIOS	125	RTGAMMA	942 616	GNDSB	55	CHAROLA TIPO MALLA
31X9CA71X -> 31X9CA73Z	SEPARADOR TRAMOS RECTOS	125	RTGAMMA	942 819 -> 942 820	ETC	53	CHAROLA TIPO MALLA
31X9CC71X -> 31X9CC75Z	TAPA FINAL	123	RTGAMMA	942 917	UFFLAT	51	CHAROLA TIPO MALLA
31X9CG71L -> 31X9CG71Z	CONECTOR	123	RTGAMMA	942 918 -> 942 922	UFSUPKIT	51	CHAROLA TIPO MALLA
31X9CG73L -> 31X9CG73Z	CONECTOR RÁPIDO	123	RTGAMMA	942 923	UFT9OKIT	51	CHAROLA TIPO MALLA
31X9CL71Z -> 31X9CL76X	ACOMETIDA A CUADRO	123	RTGAMMA	942 965-BN -> DBT-150N	BRIDA	113	DUCTO CUADRADO
31X9CT71Z -> 31X9CT75Z	EXTENSIÓN	121	RTGAMMA	DC-065-45-BN -> DC-150-90N	CODO	112	DUCTO CUADRADO
341863 -> 341867	SOPORTE TIPO CUNA	126	RTGAMMA	DCN-065-B -> DCN-150	CONECTOR	114	DUCTO CUADRADO
341877 -> 341881	SOPORTE DE JINETILLO FIJACIÓN A TECHO	126	RTGAMMA	DCN-065-BH -> DCN-150H	CONECTOR HÍBRIDO	114	DUCTO CUADRADO
341882	SUSPENSIÓN SUPERIOR CON BRIDA	127	RTGAMMA	DCN-065-BN -> DCN-150N	CONECTOR RÁPIDO	114	DUCTO CUADRADO
341884 -> 341888	SUSPENSIÓN INFERIOR CON BRIDA	126	RTGAMMA	DPC-065-BN -> DPC-150N	PLACA CIERRE	114	DUCTO CUADRADO
341889	TUBO PARA SUSPENSIÓN	127	RTGAMMA	DRE-1015-BN -> DRE-6515N	REDUCCIÓN	113	DUCTO CUADRADO
349012 -> 349215	SOPORTE TIPO ESCUADRA	125	RTGAMMA	DT-065-BN -> DT-150N	T	113	DUCTO CUADRADO
430 111 -> 430 114	G-MINI	18	CHAROLA TIPO MALLA	DTR-065-BN -> DTR-150N	TRAMO RECTO	112	DUCTO CUADRADO
556 100 -> 556 138	CSN	31, 43, 44, 49	CHAROLA TIPO MALLA	DX-065-BN -> DX-150N	X	113	DUCTO CUADRADO
556 300 -> 556 333	CSNC	40	CHAROLA TIPO MALLA	349031	HORQUILLA DE SUSPENSIÓN	127	RTGAMMA
557 010 -> 557 043	C	33	CHAROLA TIPO MALLA	KIT-MCT-01	CLIP	100	CHAROLA TIPO ESCALERILLA
557 300 -> 557 304	CEQ	37	CHAROLA TIPO MALLA	MBC-04-1 -> MBC-36-12	BAJADA	103	CHAROLA TIPO ESCALERILLA
557 410 -> 557 474	CU	31, 32, 42, 43, 44, 50	CHAROLA TIPO MALLA	MC-01 -> MC-02	CLEMA	103	CHAROLA TIPO ESCALERILLA
557 800 -> 557 803	INTERFAS	43	CHAROLA TIPO MALLA	MCA-04 -> MCA-36	CURVA HORIZONTAL AJUSTABLE	88	CHAROLA TIPO ESCALERILLA
557 920 -> 557 974	CG	42	CHAROLA TIPO MALLA	MCA-A -> MCA-S	CLIP ANGULAR	105	CHAROLA TIPO ESCALERILLA
558 011 -> 558 018	CE 25	26, 27, 81	CHAROLA TIPO MALLA	MCE-04 -> MCE-36	CONECTOR ESCALERA A CAJA	107	CHAROLA TIPO ESCALERILLA
558 041 -> 558 048	CE 30	27, 81	CHAROLA TIPO MALLA	MCH-0408-45 -> MCH-3636-90	CURVA HORIZONTAL	86, 87	CHAROLA TIPO ESCALERILLA
558 051 -> 558 058	CE 40	38, 81	CHAROLA TIPO MALLA	MCH-0408-45-FS -> MXV-3636-FSP	ACCESORIOS FONDO SÓLIDO LISO / PERFORADO	99	CHAROLA TIPO ESCALERILLA
558 201 -> 558 204	ED 1100	81	CHAROLA TIPO MALLA	MCH-0408-45-TS -> MVI-3636-90-TS	TAPAS ACCESORIOS	101	CHAROLA TIPO ESCALERILLA
558 221 -> 558 228	ED 275	26, 81	CHAROLA TIPO MALLA	MCR-01CT	CONECTOR RECTO	104	CHAROLA TIPO ESCALERILLA
558 241 -> 558 247	EDRN	23	CHAROLA TIPO MALLA	MCS-04-01 -> MCS-36-01	CANAL HORIZONTAL	106	CHAROLA TIPO ESCALERILLA
558 260	EDRN - LLAVE	23	CHAROLA TIPO MALLA	MCU-01 -> MCU-02	CLIP U	105	CHAROLA TIPO ESCALERILLA
558 320 -> 558 347	FASLOCK	25, 81	CHAROLA TIPO MALLA	MCV-01 -> MCV-02	CANAL VERTICAL	107	CHAROLA TIPO ESCALERILLA
558 410 -> 558 417	CEFAS	24	CHAROLA TIPO MALLA	MCX-01CT	CONECTOR EXPANSIÓN	104	CHAROLA TIPO ESCALERILLA
559 220	UFC	49	CHAROLA TIPO MALLA	MCZ-01CT	CONECTOR "Z"	104	CHAROLA TIPO ESCALERILLA
559 280 -> 559 287	CLMFAS	54	CHAROLA TIPO MALLA	MCZ-N-01CT	CONECTOR RÁPIDO "Z"	104	CHAROLA TIPO ESCALERILLA
559 301	PA23	53	CHAROLA TIPO MALLA	MD-04 -> MD36-I	DERIVACIÓN 45°	97	CHAROLA TIPO ESCALERILLA
559 507	COUPEFILGM	80	CHAROLA TIPO MALLA	MEA-01	ELEVADOR	104	CHAROLA TIPO ESCALERILLA
559 548	CUTYFIL	80	CHAROLA TIPO MALLA	MJE-04 -> MJE-36	JUNTA EXPANSIÓN	102	CHAROLA TIPO ESCALERILLA
559 677	CABLOGRIP	58	CHAROLA TIPO MALLA	MMP-04 -> MMP36	MÉNSULA DE PARED	103	CHAROLA TIPO ESCALERILLA
561 010 -> 561 014	EDF	33, 42	CHAROLA TIPO MALLA	MPC-04 -> MPC-36	PLACA CIERRE	102	CHAROLA TIPO ESCALERILLA
561 060 -> 561 064	DF	50	CHAROLA TIPO MALLA	MRL-0604-D -> MRL 3630-I	REDUCCIÓN LATERAL	92	CHAROLA TIPO ESCALERILLA
561 080 -> 561 084	PFREDF	42	CHAROLA TIPO MALLA	MRR-0604 -> MRR-3630	REDUCCIÓN RECTA	91	CHAROLA TIPO ESCALERILLA
561 100 -> 561 103	SI	33	CHAROLA TIPO MALLA	MTH-0404-8 -> MTH-3636-36	T HORIZONTAL	90	CHAROLA TIPO ESCALERILLA
561 320 -> 561 610	EDF	51	CHAROLA TIPO MALLA	MTR-0406 -> MTR-3618	TRAMO RECTO	85	CHAROLA TIPO ESCALERILLA
585 110 -> 585 114	SBD	57	CHAROLA TIPO MALLA	MTR-04-2A -> MTR-36-2A	TAPA 2 AGUAS	100	CHAROLA TIPO ESCALERILLA
585 130	EXSBD	57	CHAROLA TIPO MALLA	MTR-04-FS -> MTR-36-FSP	FONDO SÓLIDO LISO / PERFORADO	98	CHAROLA TIPO ESCALERILLA
585 145	MFPOLYA	57	CHAROLA TIPO MALLA	MTR-04-TLS -> MTR-36-TLS	TAPA LISA	100	CHAROLA TIPO ESCALERILLA
585 160 -> 585 167	DEV 100	58	CHAROLA TIPO MALLA	MTR-5-122	SEPARADOR RECTO	107	CHAROLA TIPO ESCALERILLA
585 407	BLF	55	CHAROLA TIPO MALLA	MTV-0404-8 -> MTV-3636-36	T VERTICAL	96	CHAROLA TIPO ESCALERILLA
585 410 -> 585 417	SBDN	56	CHAROLA TIPO MALLA	MVE-0408-45 -> MVI-3636-90	CURVA VERTICAL	93, 94	CHAROLA TIPO ESCALERILLA
586 020 -> 586 024	AS	40	CHAROLA TIPO MALLA	MVR-1/2-1 -> MVR-3/8-3	VARILLA ROSCADA	106	CHAROLA TIPO ESCALERILLA
586 031 -> 586 037	SAS	38	CHAROLA TIPO MALLA	MXH-0404-8 -> MXH-3636-36	X HORIZONTAL	89	CHAROLA TIPO ESCALERILLA
586 040 -> 586 048	UC 50	30, 34, 37, 48	CHAROLA TIPO MALLA	MXV-0404-8 -> MXV-3636-36	Y VERTICAL	95	CHAROLA TIPO ESCALERILLA
586 080 -> 586 084	RSS	34, 47	CHAROLA TIPO MALLA	UAF-010 -> UAF-800	ABRAZADERA	115	UNICANAL
586 100 -> 586 144	SF 50/100	37	CHAROLA TIPO MALLA	UNF-42 -> UNF-44-16-P	UNICANAL	43, 44, 115	UNICANAL
586 130 -> 586 138	CM50XL	30, 35, 38, 46, 56	CHAROLA TIPO MALLA	UTR-1/2 -> UTR-5/16	TUERCA CON RESORTE	115	UNICANAL
586 160 -> 586 164	UC35	17, 18	CHAROLA TIPO MALLA	UNF-42 -> UNF-44-16-P	UNICANAL	43, 44, 115	UNICANAL
586 180 -> 586 184	FTX	17, 18, 47	CHAROLA TIPO MALLA	UTR-1/2 -> UTR-5/16	TUERCA CON RESORTE	115	UNICANAL
586 200 -> 586 600	SCF	39	CHAROLA TIPO MALLA				
586 210	PFSFC	39	CHAROLA TIPO MALLA				
586 810 -> 586 830	EXT-SCF	39	CHAROLA TIPO MALLA				

ÍNDICE POR DESCRIPCIÓN

Descripción	Código	Página	Línea
ABRAZADERA	UAF-010 -> UAF-800	115	UNICANAL
ACCESORIOS FONDO SÓLIDO LISO /PERFORADO	MCH-0408-45-FS -> MXV-3636-FSP	99	CHAROLA TIPO ESCALERILLA
ACOMETIDA A CUADRO	31X9CL71Z -> 31X9CL76X	123	RTGAMMA
ÁNGULO PLANO 30°	31ALC075Z -> 31ALC300Z	121	RTGAMMA
ÁNGULO PLANO 45°	31AJC075X -> 31AJC300Z	120	RTGAMMA
ÁNGULO PLANO 90°	31AIC075X -> 31AIC300Z	120	RTGAMMA
AS	586 020 -> 586 024	40	CHAROLA TIPO MALLA
BAJADA	MBC-04-1 -> MBC-36-12	103	CHAROLA TIPO ESCALERILLA
BLF	585 407	55	CHAROLA TIPO MALLA
BRIDA	DBT-065-BN -> DBT-150N	113	DUCTO CUADRADO
BTRCC	801 017 -> 801 018	26, 27, 80	CHAROLA TIPO MALLA
BTRCC	941 059	26, 27, 80	CHAROLA TIPO MALLA
BTRCC	941 084	26, 27, 80	CHAROLA TIPO MALLA
C	557 010 -> 557 043	33	CHAROLA TIPO MALLA
C41S	595 013 -> 595 064	33, 44, 53	CHAROLA TIPO MALLA
CABLOGRIP	559 677	58	CHAROLA TIPO MALLA
CAMBIO DE NIVEL 90° DERECHO	31AZC075X -> 31AZC300Z	123	RTGAMMA
CAMBIO DE NIVEL 90° IZQUIERDA	31AYC075X -> 31AYC300Z	122	RTGAMMA
CAMBIO NIVEL CÓNCAVO	31AMC075X -> 31AMC300Z	122	RTGAMMA
CAMBIO NIVEL CONVEXO	31APC075X -> 31APC300Z	122	RTGAMMA
CANAL HORIZONTAL	MCS-04-01 -> MCS-36-01	106	CHAROLA TIPO ESCALERILLA
CANAL VERTICAL	MCV-01 -> MCV-02	107	CHAROLA TIPO ESCALERILLA
CE 2S	558 011 -> 558 018	26, 27, 81	CHAROLA TIPO MALLA
CE 30	558 041 -> 558 048	27, 81	CHAROLA TIPO MALLA
CE 40	558 051 -> 558 058	38, 81	CHAROLA TIPO MALLA
CEFAS	558 410 -> 558 417	24	CHAROLA TIPO MALLA
CEFQ	557 300 -> 557 304	37	CHAROLA TIPO MALLA
CF10S, CF150	941 072 -> 941 080	15, 16	CHAROLA TIPO MALLA
CF30, CF54, CF10S, CF150	000 011 -> 001 034	13, 14, 15, 16	CHAROLA TIPO MALLA
CG	557 920 -> 557 974	42	CHAROLA TIPO MALLA
CHAROLA PVC	637 760 -> 637 988	142 - 145	CHAROLA PVC
CLEMA	MC-01 -> MC-02	103	CHAROLA TIPO ESCALERILLA
CLIP	KIT-MCT-01	100	CHAROLA TIPO ESCALERILLA
CLIP ANGULAR	MCA-A -> MCA-S	105	CHAROLA TIPO ESCALERILLA
CLIP F	646 200 -> 646 207	20	CHAROLA TIPO MALLA
CLIP FIJACIÓN	31X9Y9999	124	RTGAMMA
CLIP U	MCU-01 -> MCU-02	105	CHAROLA TIPO ESCALERILLA
CLMFAS	559 280 -> 559 287	54	CHAROLA TIPO MALLA
CM 100	595 900 -> 595 920	52	CHAROLA TIPO MALLA
CMSOXL	586 130 -> 586 138	30, 35, 38, 46, 56	CHAROLA TIPO MALLA
CODO	DC-065-45-BN -> DC-150-90N	112	DUCTO CUADRADO
CONECTOR	31X9CG71L -> 31X9CG71Z	123	RTGAMMA
CONECTOR	DCN-065-B -> DCN-150	114	DUCTO CUADRADO
CONECTOR "Z"	MCZ-01CT	104	CHAROLA TIPO ESCALERILLA
CONECTOR ESCALERA A CAJA	MCE-04 -> MCE-36	107	CHAROLA TIPO ESCALERILLA
CONECTOR EXPANSIÓN	MCX-01CT	104	CHAROLA TIPO ESCALERILLA
CONECTOR HÍBRIDO	DCN-065-BH -> DCN-150H	114	DUCTO CUADRADO
CONECTOR RÁPIDO	31X9CG73L -> 31X9CG73Z	123	RTGAMMA
CONECTOR RÁPIDO	DCN-065-BN -> DCN-150N	114	DUCTO CUADRADO
CONECTOR RÁPIDO "Z"	MCZ-N-01CT	104	CHAROLA TIPO ESCALERILLA
CONECTOR RECTO	MCR-01CT	104	CHAROLA TIPO ESCALERILLA
COT	923 010 -> 923 048	21	CHAROLA TIPO MALLA
COT J	923 050 -> 923 054	21	CHAROLA TIPO MALLA
COUPFILGM	559 507	80	CHAROLA TIPO MALLA
CP	646 010 -> 646 084	20	CHAROLA TIPO MALLA
CP35	755 100 -> 755 104	17	CHAROLA TIPO MALLA
CSN	556 100 -> 556 138	31, 43, 44, 49	CHAROLA TIPO MALLA
CSNC	556 300 -> 556 333	40	CHAROLA TIPO MALLA
CU	557 410 -> 557 474	31, 32, 42, 43, 44, 50	CHAROLA TIPO MALLA
CURVA HORIZONTAL	MCH-0408-45 -> MCH-3636-90	86, 87	CHAROLA TIPO ESCALERILLA
CURVA HORIZONTAL AJUSTABLE	MCA-04 -> MCA-36	88	CHAROLA TIPO ESCALERILLA
CURVA VERTICAL	31AUCC075Z -> 31AUC300Z	122	RTGAMMA
CURVA VERTICAL	MVE-0408-45 -> MVI-3636-90	93, 94	CHAROLA TIPO ESCALERILLA
CUTYFIL	559 548	80	CHAROLA TIPO MALLA
CVN	629 050 -> 629 604	20	CHAROLA TIPO MALLA
DERIVACIÓN 45°	MD-04 -> MD36-1	97	CHAROLA TIPO ESCALERILLA
DERIVACIÓN PLANA EN T	31ASC075X -> 31ASC300Z	121	RTGAMMA
DERIVACIÓN PLANA EN X	31ATC075X -> 31ATC300Z	121	RTGAMMA
DERIVACIÓN VERTICAL T	31AWC075X -> 31AWC300Z	122	RTGAMMA
DERIVACIÓN VERTICAL T - VARIACIÓN DE PLANO	31AXC075X -> 31AXC300Z	123	RTGAMMA
DEV 100	585 160 -> 585 167	58	CHAROLA TIPO MALLA
DF	561 060 -> 561 064	50	CHAROLA TIPO MALLA
ED 1100	558 201 -> 558 204	81	CHAROLA TIPO MALLA
ED 275	558 221 -> 558 228	26, 81	CHAROLA TIPO MALLA
EDF	561 010 -> 561 014	33, 42	CHAROLA TIPO MALLA
EDF	561 320 -> 561 610	51	CHAROLA TIPO MALLA
EDRN	558 241 -> 558 247	23	CHAROLA TIPO MALLA
EDRN - LLAVE	558 260	23	CHAROLA TIPO MALLA
ELEVADOR	MEA-01	104	CHAROLA TIPO ESCALERILLA
ETC	942 819 -> 942 820	53	CHAROLA TIPO MALLA
EXSBD	585 130	57	CHAROLA TIPO MALLA
EXTENSIÓN	31X9CT71Z -> 31X9CT75Z	121	RTGAMMA
EXT-SCF	586 810 -> 586 830	39	CHAROLA TIPO MALLA
EZ-PATH	250 018 -> 250 518	59, 60	CHAROLA TIPO MALLA

Descripción	Código	Página	Línea
FAS ROLLER	011 100	58	CHAROLA TIPO MALLA
FASLOCK	558 320 -> 558 347	25, 81	CHAROLA TIPO MALLA
FCF54 FASCLIC	081 061 -> 081 094	19	CHAROLA TIPO MALLA
FONDO SÓLIDO LISO / PERFORADO	MTR-04-FS -> MTR-36-FSP	98	CHAROLA TIPO ESCALERILLA
FS41 FASSTRUT	599 007 -> 599 004	41, 81	CHAROLA TIPO MALLA
FTX	586 180 -> 586 184	17, 18, 47	CHAROLA TIPO MALLA
G-MINI	430 111 -> 430 114	18	CHAROLA TIPO MALLA
GNSDB	942 616	55	CHAROLA TIPO MALLA
HORQUILLA DE SUSPENSIÓN	349031	127	RTGAMMA
IBP	091 937 -> 091 938	54	CHAROLA TIPO MALLA
INTERFAS	557 800 -> 557 803	43	CHAROLA TIPO MALLA
JUNTA EXPANSIÓN	MJE-04 -> MJE-36	102	CHAROLA TIPO ESCALERILLA
MÉNSULA DE PARED	MMP-04 -> MMP36	103	CHAROLA TIPO ESCALERILLA
MFPOLYA	585 145	57	CHAROLA TIPO MALLA
PA1, PA2, PA3	840 101 -> 840 133	25	CHAROLA TIPO MALLA
PA23	559 301	53	CHAROLA TIPO MALLA
PFREFD	561 080 -> 561 084	42	CHAROLA TIPO MALLA
PESCF	586 210	39	CHAROLA TIPO MALLA
PLACA CIERRE	DPC-065-BN -> DPC-150N	114	DUCTO CUADRADO
PLACA CIERRE	MPC-04 -> MPC-36	102	CHAROLA TIPO ESCALERILLA
PLACA DE CONEXIÓN A TIERRA	31X9X999 -> 31X9X99X	124	RTGAMMA
PLACA DE FIJACIÓN DE CABLES	31X9J99Z	124	RTGAMMA
R55	586 080 -> 585 084	34, 47	CHAROLA TIPO MALLA
RCSN	014 030 -> 014 038	35, 41, 46, 49	CHAROLA TIPO MALLA
REDUCCIÓN	31AHC375Z -> 31X9CS51X	121	RTGAMMA
REDUCCIÓN	DRE-1015-BN -> DRE-6515N	113	DUCTO CUADRADO
REDUCCIÓN LATERAL	MRL-0604-D -> MRL 3630-1	92	CHAROLA TIPO ESCALERILLA
REDUCCIÓN RECTA	MRR-0604 -> MRR-3630	91	CHAROLA TIPO ESCALERILLA
SAS	586 031 -> 586 037	38	CHAROLA TIPO MALLA
SBD	585 110 -> 585 114	57	CHAROLA TIPO MALLA
SBDN	585 410 -> 585 417	56	CHAROLA TIPO MALLA
SCF	586 200 -> 586 600	39	CHAROLA TIPO MALLA
SEPARADOR ACCESORIOS	31X9CA72Z	125	RTGAMMA
SEPARADOR RECTO	MTR-S-122	107	CHAROLA TIPO ESCALERILLA
SEPARADOR TRAMOS RECTOS	31X9CA71X -> 31X9CA73Z	125	RTGAMMA
SF 50/100	586 100 -> 586 144	37	CHAROLA TIPO MALLA
SI	561 100 -> 561 103	33	CHAROLA TIPO MALLA
SOPORTE DE JINETILLO FIJACIÓN A TECHO	341877 -> 341881	126	RTGAMMA
SOPORTE TIPO CUNA	341863 -> 341867	126	RTGAMMA
SOPORTE TIPO ESCUADRA	349012 -> 349215	125	RTGAMMA
SU41	595 340	44	CHAROLA TIPO MALLA
SUSPENSIÓN INFERIOR CON BRIDA	341884 -> 341888	126	RTGAMMA
SUSPENSIÓN SUPERIOR CON BRIDA	341882	127	RTGAMMA
T	DT-065-BN -> DT-150N	113	DUCTO CUADRADO
T HORIZONTAL	MTH-0404-8 -> MTH-3636-36	90	CHAROLA TIPO ESCALERILLA
T VERTICAL	MTV-0404-8 -> MTV-3636-36	96	CHAROLA TIPO ESCALERILLA
TAPA	31L29075Z -> 31L39300X	120	RTGAMMA
TAPA 2 AGUAS	MTR-04-2A -> MTR-36-2A	100	CHAROLA TIPO ESCALERILLA
TAPA FINAL	31X9CC71X -> 31X9CC75Z	123	RTGAMMA
TAPA LISA	MTR-04-TLS -> MTR-36-TLS	100	CHAROLA TIPO ESCALERILLA
TAPAS ACCESORIOS	MCH-0408-45-TS -> MVI-3636-90-TS	101	CHAROLA TIPO ESCALERILLA
TORNILLO FIJACIÓN	03V 1M6 10L -> 03 1M6 10Z	125	RTGAMMA
TRAMO RECTO	31C2C075Z -> 31C3C300X	120	RTGAMMA
TRAMO RECTO	DTR-065-BN -> DTR-150N	112	DUCTO CUADRADO
TRAMO RECTO	MTR-0406 -> MTR-3618	85	CHAROLA TIPO ESCALERILLA
TUBO PARA SUSPENSIÓN	341889	127	RTGAMMA
TUERCA CON RESORTE	UTR-1/2 -> UTR-5/16	115	UNICANAL
TXF35	755 001 -> 755 008	17	CHAROLA TIPO MALLA
UC 100	595 930	52	CHAROLA TIPO MALLA
UC 50	586 040 -> 586 048	30, 34, 37, 48	CHAROLA TIPO MALLA
UC35	586 160 -> 586 164	17, 18	CHAROLA TIPO MALLA
UFC	559 220	49	CHAROLA TIPO MALLA
UFCE 54	600 261 -> 600 901	50	CHAROLA TIPO MALLA
UFEN	942 448 -> 942 839	50	CHAROLA TIPO MALLA
UFERSBAR	589 010	51	CHAROLA TIPO MALLA
UFFLAT	942 917	51	CHAROLA TIPO MALLA
UFI 41	595 353	53	CHAROLA TIPO MALLA
UFFSTCLP	589 110	51	CHAROLA TIPO MALLA
UFS	942 354	48	CHAROLA TIPO MALLA
UFSUPKIT	942 918 -> 942 922	51	CHAROLA TIPO MALLA
UFT90KIT	942 923	51	CHAROLA TIPO MALLA
UFTXSPRCLP	589 210	51	CHAROLA TIPO MALLA
UNICANAL	UNF-42 -> UNF-44-16-P	43, 44, 115	UNICANAL
VARILLA ROSCADA	MVR-1/2-1 -> MVR-3/8-3	106	CHAROLA TIPO ESCALERILLA
X	DX-065-BN -> DX-150N	113	DUCTO CUADRADO
X HORIZONTAL	MXH-0404-8 -> MXH-3636-36	89	CHAROLA TIPO ESCALERILLA
X VERTICAL	MXV-0404-8 -> MXV-3636-36	95	CHAROLA TIPO ESCALERILLA
X HORIZONTAL	MXH-0404-8 -> MXH-3636-36	89	CHAROLA TIPO ESCALERILLA
X VERTICAL	MXV-0404-8 -> MXV-3636-36	95	CHAROLA TIPO ESCALERILLA

BTicino de México, S.A. de C.V.
Carr. 57, Qro. a S.L.P., km. 22.7, C.P. 76220
Sta. Rosa Jáuregui, Querétaro, México.
Tel: (442) 238 04 00 Fax: (442) 238 04 82
Sin costo: 01 800 714 8524
E-mail: solucionesmx@bticino.com



**Asistencia telefónica, capacitación y certificación,
asesoría en proyectos, catálogos, exhibición,
centro de cotizaciones.**

www.bticino.com.mx

OFICINAS COMERCIALES

Zona Metropolitana Show Room Ciudad de México

Montes Urales 715, 3er piso
Col. Lomas de Chapultepec
11000, México, D.F.
Tel: (55) 52 01 64 50
Fax: (55) 52 01 64 51
Sin costo: 01 800 BTICINO
01 800 2842466
E-mail: zona.metropolitana@bticino.com

Zona Pacífico Show Room Guadalajara

Av. Circunvalación
Agustín Yañez 2613-1B
Col. Arcos Vallarta Sur
44500, Guadalajara, Jalisco.
Tels: (33) 36 16 99 04
Fax: (33) 36 16 99 40
Sin costo: 01 800 BTICINO
01 800 2842466
E-mail: zona.pacifico@bticino.com

Zona Centro Show Room Querétaro

Carr. 57, Qro. a S.L.P., km 22.7
76220, Sta. Rosa Jáuregui, Qro.
Tel: (442) 238 04 90
Fax: (442) 238 04 86
Sin costo: 01 800 BTICINO
01 800 2842466
E-mail: zona.centro@bticino.com

Zona Norte Show Room Monterrey

Av. Francisco I. Madero 1605 Pte.
Col. Centro
64000, Monterrey, N.L.
Tels: (81) 83 72 23 61
Sin costo: 01 800 713 48 48
Fax: (81) 83 72 23 65
Sin costo: 01 800 BTICINO
01 800 2842466
E-mail: zona.norte@bticino.com

Zona Golfo

Bernal Díaz del Castillo 155-B
Esquina Juan Pablo II
Fracc. Virginia
94294, Boca del Río, Ver.
Tel: (229) 935 13 90
Tel/Fax: (229) 935 68 51
Sin costo: 01 800 BTICINO
01 800 2842466
E-mail: zona.golfo@bticino.com

BTicino de México, S.A. de C.V. se reserva el derecho de variar las características de los productos que se muestran en este catálogo.

bticino